



**SHENZHEN ATESS POWER TECHNOLOGY CO.,LTD**

GROWATT-ATESS Industrial Park, No.23 Zhulongtian Road, Shuitian Community,  
Shiyan Street, Baoan District, Shenzhen

Tel: +86 755 2998 8492

Web: [www.atesspower.com](http://www.atesspower.com)

Email: [info@atesspower.com](mailto:info@atesspower.com)

Revised date: 2026-06-26

**ATESS SMC200HV**  
Solar Charge Controller  
User Manual

# Contents

## 1 About this Manual

- 1.1 Content Introduction
- 1.2 Target readers
- 1.3 Manual usage

## 2 Safety Notice

- 2.1 Symbol Instructions
- 2.2 Usage Notice
- 2.3 Correct installation method
- 2.4 Operator
- 2.5 Important precautions

## 3 Product Description

- 3.1 Optical Storage System
- 3.2 Electrical Principle of Controller
- 3.3 Layout of main parts
- 3.4 Operating mode
- 3.5 Notice of load usage
- 3.6 Size and weight
- 3.7 Packaging Information

## 4 Product transportation and storage

- 4.1 Transportation of the product
- 4.2 Inspection and storage of the products

## 5 Product Installation

- 5.1 Requirements for installation conditions
- 5.2 Tools and spare parts required for the installation
- 5.3 Mechanical Installation
- 5.4 Electrical Installation
- 5.5 Communication
- 5.6 Single-parallel system wiring with CAN communication wiring

## 6 Initial Power On

- 6.1 Pre-operation Inspection
- 6.2 Power On

## 7 Man-Machine Interface

- 7.1 Introduction to Touch Screen
- 7.2 Upper computer operation
- 7.3 LCD Display Information Schedule

## 8 Operation

- 8.1 Startup and operation steps
- 8.2 Complete the trial run
- 8.3 Shutdown and power-off steps

## 9 Product Maintenance

- 9.1 Routine Maintenance
- 9.2 Waste Disposal

## 10 Accessories

- 10.1 Product Specifications
- 10.2 ATESS Factory Warranty

# 1 About this Manual

The purpose of this chapter is to provide an overview of the manual's content and target audience, facilitating users' comprehension of its contents.

## 1.1 Content Introduction

The present manual is applicable to the ATESS SMC200HV solar charge controller products (hereinafter referred to as SMC200HV). It encompasses the following key contents:

- **Safety Notice**

The safety concerns related to SMC200HV.

- **Product Description**

The function, structure, and principle of SMC200HV, as well as the size and packaging of SMC200HV, along with its operational mode and other relevant information.

Product Transportation and Storage

The transportation mode of the product and the storage-related precautions.

- **Product Installation**

Conditions for SMC200HV installation, required tools, mechanical and electrical installation of SMC200HV, communication connections, and other relevant information.

- **The product is powered on for the first time**

The information regarding essential procedures to be conducted during the initial power-on of the SMC200HV.

- **Man-machine interface operation guide**

Interface display information of the LCD touch screen for SMC200HV, operation setting method and other information.

- **Operation**

Information such as SMC200HV startup and shutdown steps.

- **Product Maintenance**

Routine maintenance of SMC200HV, waste disposal and other information.

- **Attachments**

The technical data, quality assurance terms, and contact information of SMC200HV.

## 1.2 Target readers

The applicable personnel should possess the following qualifications:

- Only professional electricians or individuals with professional certifications are authorized to carry out transportation, installation, and other operations of this product;
- The operators must have a comprehensive understanding of the composition and working principle of the entire energy storage system.
- The operators should be fully acquainted with the user manual for this product;
- The operators should be fully familiar with the relevant standards of the country/region where the project is located.







## 1.3 Manual usage

Before installing or using the equipment, it is essential to thoroughly review this manual. It is recommended to keep this manual and relevant information readily accessible alongside the product components for easy reference by authorized personnel. Please note that the contents of this manual will be continuously updated and revised; therefore, there may be occasional inconsistencies or errors with respect to the actual product. The purchased product shall prevail over any discrepancies found herein. For further assistance, users can contact the local distributor or access the latest version of this manual through our website [www.atesspower.com](http://www.atesspower.com).

## 2 Safety Notice

### 2.1 Symbol Instructions

In order to ensure the safety of users' personal belongings and property during installation, as well as to maximize the efficiency and optimal usage of this product, pertinent information is provide in the manual emphasized through appropriate symbols. The following enumerates the symbols that may be utilized this manual. Please carefully review them to enhance your utilization of this manual.

	<b>DANGER</b> DANGER indicates a hazard with a high level of risk which, if not avoided, will result in death or serious injury.
	<b>CAUTION</b> CAUTION indicates there is potential risk, if not avoided, could result in equipment malfunction and property damage.
	<b>Caution, risk of electric shock</b> When battery bank connecting point are exposed, there will be DC voltage in the equipment DC side; and when output breaker is on, there is a potential risk of electric shock.
	<b>Caution, risk of fire hazard</b> Suitable for mounting on concrete or other non-combustible surface only.
	<b>Protective conductor terminal</b> The inverter has to be firmly grounded to ensure the safety of personnel.
	<b>Risk of electric shock, Energy storage timed discharge</b> Electrical shock danger exists in the capacitor; the cover shall be moved at least 5 minutes later after all powers are disconnected.

### 2.2 Usage Notice

All SMC200HV installation and service personnel must undergo training to ensure their familiarity with general regulations for working on electrical equipment. Additionally, they should be well-versed in safety codes and requirements.

- Prior to usage, it is essential to thoroughly read this manual. Failure to operate the equipment according to the instructions provided may result in a void of quality assurance by the company.

- Only qualified electrical engineers are permitted to operate SMC200HV devices.
- While the device is operational, refrain from touching any other electrical components except when necessary checking device operation information via the display screen.
- All electrical operations must adhere to local standards for electrical operations.
- The utilization of on-grid SMC200HV charge and discharge requires authorization from the local power supply department and should only be carried out by professionals.

### 2.3 Correct Installation Method

The proper installation of a SMC200HV entails adhering to all instructions outlined in the owners' manual pertaining to equipment transportation, installation, electrical connection, and operation. ATESS shall not be held liable for any damages resulting from improper usage of the equipment.

The SMC200HV possess an IP65 protection progress and is specifically designed for indoor installations. During the installation process, it it imperative to carefully review the information provided in the user manual, particularly Chapter 5 titled "Product Installation".

Additionally, ensuring appropriate utilization of the equipment necessitates attentiveness towards:

- Acknowledging safety instructions listed herein and below;
- Heeding guidelines presented within the SMC200HV user manual;
- Considering technical data associated with this device.

### 2.4 Operator

Only electricians who have received training and approval from the power supply company are authorized to install and conduct test runs on a SMC200HV. Prior to installation, all installation and service personnel must undergo training and become familiar with the fundamental safety requirements for operating electrical equipment. Additionally, installation and service personnel should be knowledgeable about relevant local regulations and safety protocols.

### 2.5 Important Precautions



**Note1: Static electricity can cause damage to SMC200HV**

Due to the electrostatic discharge, it has the potential to result in irreversible damage to the internal components of SMC200HV.

**Note2: Usage restrictions**

Direct connection of life AIDS and medical devices with SMC200HV is prohibited!

**Note3: Tool precautions**

Prior to powering on, thoroughly inspect for any installation tools or other unnecessary items left inside the SMC200HV.

**Note4: Maintenance precautions**

Ensure the SMC200HV has been safely powered off during maintenance and all live machine components have been discharged before proceeding.

# 3 Product Description

## 3.1 Optical Storage System

The SMC200HV series, manufactured by ATESS, is a solar charge controller system designed to efficiently distribute photovoltaic direct current to energy storage batteries. Currently, the SMC200HV is predominantly utilized in conjunction with PCS energy storage systems, as illustrated in the following diagram:

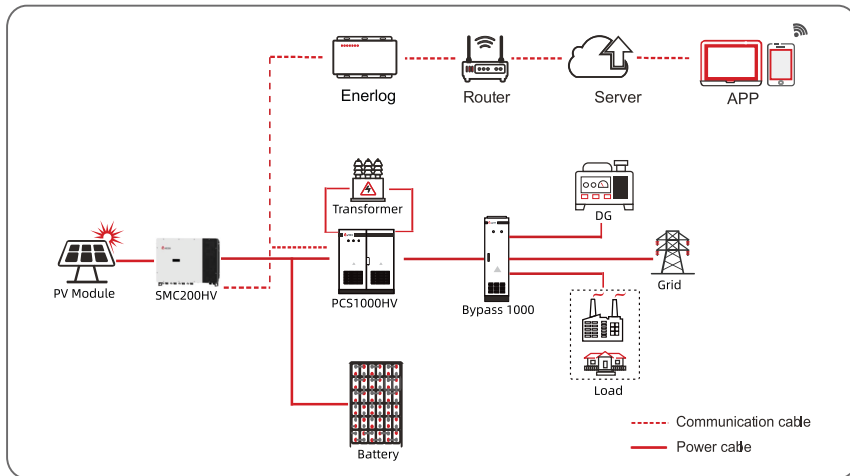

SMC200HV+PCS+bypass system diagram

## 3.2 Electrical Principle of Controller

The SMC200HV is a first-level Buck-Boost circuit designed to match the battery output and utilize voltage reduction for efficient battery charging.

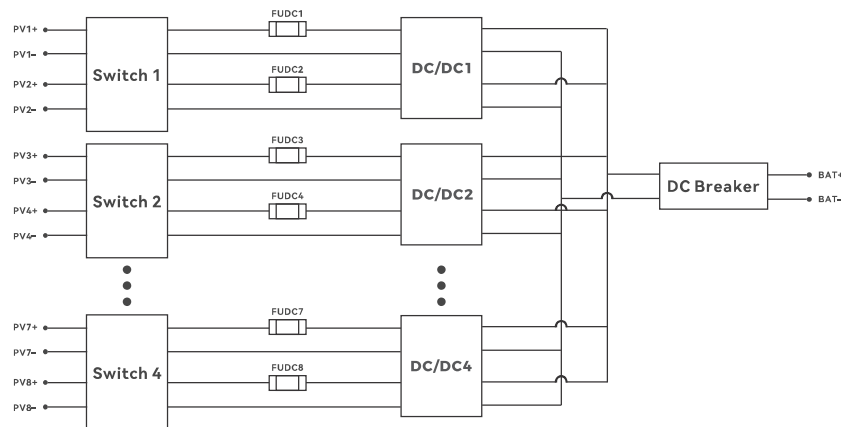

Electrical Schematic Diagram of SMC200HV

## 3.3 The layout of the main components

### 3.3.1 External components

The main external components of SMC200HV include: LED indicator lights, disconnectors, PV terminal blocks, etc.

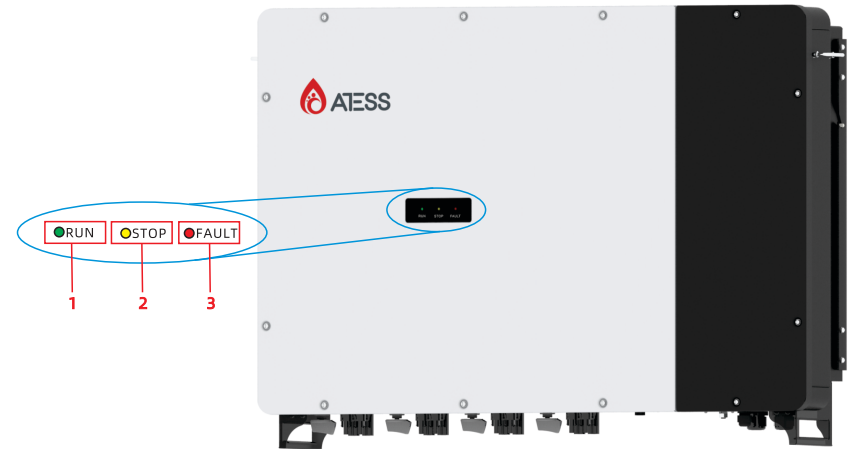

Figure 3-3-1-1 Exterior description of a SMC200HV

S/N	Part Name	Description
1	RUN indicator	When the SMC200HV system is running, this indicator is on, bright green
2	FAULT indicator	When the SMC200HV fails to work, the indicator lights up and turns red
3	STOP	This indicator is always on when the SMC200HV is waiting or checking

Figure 3-3-1 Part description

### Indicator

This SMC200HV features an intelligent design. At the top of the inverter power supply are three LED lights that show the main operating status of the machine. The current working status of the SMC200HV can be seen through the LED indicator lights.



Figure 3-3-1-2 Equipment operation indicator LED

LED	Meaning
RUN	The indicator light is always on when the SMC200HV system is running
STOP	When the SMC200HV is in the waiting or checking state, this indicator light remains on constantly
FAULT	The indicator light stays on when the SMC200HV fails to work

Table 3-3-2 LED operating status

### 3.3.2 Internal Components

The internal components of SMC200HV include: disconnectors, output circuit breakers, PV lightning protection, PCB boards, etc. The following are pictures of the internal components on the front and back of the SMC200HV.

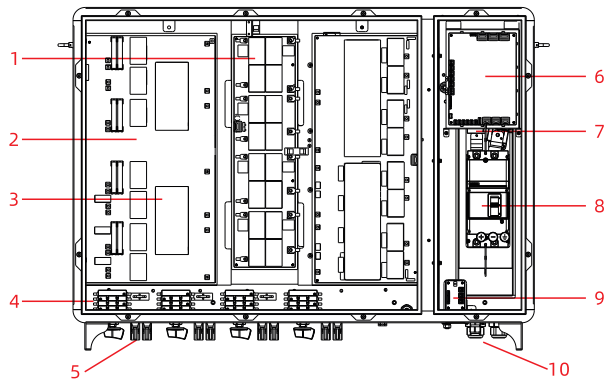

SMC200HV front interior components view

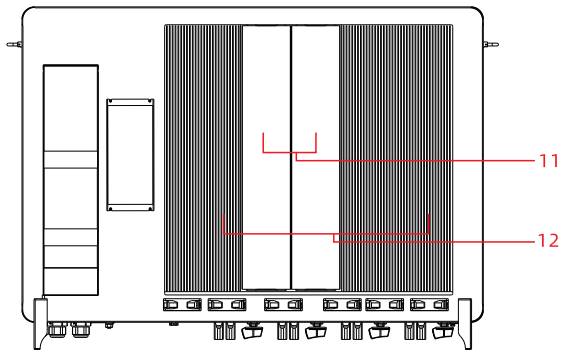

Interior components of SMC200HV back

Model	SMC200HV	
Serial number	Part Name	Instructions
1	Output capacitor board	Output filter capacitor
2	BUCK power board	Achieve PV voltage reduction
3	BUCK drives the power board	Provide drive power to the power board
4	PV disconnector	Control the disconnection of the PV from the machine
5	PV MC4 interface	PV input, connect to the PV module interface
6	Control panel	Main control board
7	Output current sampling hall	Sample the total output current
8	Battery circuit breaker	Control the disconnection of the battery from the machine
9	Interface board	Communication interface
10	SMC200HV Output interface	Connect the battery
11	Potting inductor heat sink	Cool the potting inductor
12	IGBT heat sink	Cool the output IGBT

### 3.4 Operating mode

Currently, the operation mode needs to be used in conjunction with the PCS energy storage machine, the SMC200HV output terminal is connected to the PCS bus terminal for use, and the mode selection needs to be selected on the PCS screen. The SMC200HV itself does not have a battery.

### 3.4.1 Failure Mode

When the SMC200HV fails, the circuit breaker on the output side will be immediately disconnected and shut down to enter the fault state, thus ensuring system safety. At this time, the SMC200HV will continuously monitor whether the fault has been eliminated, and if the fault has not been eliminated, it will remain in a faulty state; After the fault is eliminated, you can restart.

### 3.4.2 Permanent Failure Mode

When a relatively serious fault occurs in the SMC200HV, the SMC200HV power supply will immediately open the output circuit breaker and enter a permanent fault state to ensure the safety of the system. When permanent fault information is detected three times in a row, the output circuit breaker will be disconnected. For example: Information such as a fault in the SMC200HV module of the SMC200HV. Generally, when the SMC200HV enters this permanent failure mode, do not repair the SMC200HV on your own. Instead, contact the local dealer or call Shenzhen ATESS Power Technology Co., Ltd. for assistance.

### 3.4.3 Abnormal output power

When the ambient temperature is too high, the output power of the storage SMC200HV will normally decrease. However, if this happens frequently, check the cooling surface of the SMC200HV or place the SMC200HV in a well-ventilated area. If the SMC200HV fan is dirty, clean the fan dust, and if there is a problem inside the SMC200HV, seek help from a professional service department.

### 3.5 Notice of load usage

Nowadays, the SMC200HV series are all used in conjunction with PCS energy storage machines. The SMC200HV only outputs DC, and the output end needs to be connected to the PCS bus for voltage stabilization in order to be used normally. Remember: SMC200HV cannot operate without PCS output terminals.

Model	SMC200HV
Rated power (KW)	180
DC load MAX (KW)	200

If the DC load power is greater than the rated output power of the selected model, multiple SMCs in parallel are recommended.

### 3.6 Size and weight

Model	SMC200HV
Dimensions (width * height * thickness)	985*675*210mm
Weight	81kg

Table 3-8 SMC200HV sizes

### 3.7 Packaging Information

Serial number	Name	Units	Quantity	Notes
1	SMC200HV complete machine	PCS	1	
2	User Manual	PCS	1	
3	Certificate of conformity	PCS	1	
4	Factory test report	PCS	1	

## 4 Transportation and Storage

### 4.1 Transportation of the product

When transporting the SMC200HV, the user is only permitted to use the transportation method described in the user manual.

### 4.2 Inspection and storage of the product

The user should carefully inspect the SMC200HV delivered by the shipping company before signing for it. Inspect the received items against the items listed in the delivery notice. If any defects or damages are found, notify the shipping company immediately and ask it to appraise the equipment. You may seek assistance from Shenzhen ATESS Power Technology Co., Ltd. if necessary.



#### Attention!

This device can only be stored in a package, so make sure it is dust-proof and moisture-proof inside. If it is to be stored for a long time, the SMC200HV must be kept in a dry environment to prevent water from entering the SMC200HV.

## 5 Product Installation

### 5.1 Requirements for installation conditions

To ensure the machine works properly, the installation environment and requirements are as follows:

- This SMC200HV has a protection rating of IP65, and the product is an electronic device, so do not place it in damp areas;
- Outdoor installation is permitted, but avoid direct sunlight and rain as much as possible;
- Good ventilation around the machine;
- Install away from bad environments such as sand, dust, corrosive gases, etc.
- The equipment will generate some noise during operation, so it should be installed away from residential areas as much as possible;
- Install the ground to ensure it does not shake, and the support surface should meet the load-bearing requirements of the SMC200HV;

- The installation location should be ensured to be easy to maintain;
- Ambient temperature between  $-25^{\circ}\text{C}$  and  $55^{\circ}\text{C}$ ;
- The machine should reserve sufficient space for ventilation and heat dissipation.
- Wall requirements

This SMC200HV is required to be mounted on a flat wall with a flame-retardant surface or a channel steel support structure, and the wall must not be dented or tilted. It is necessary to ensure that the wall is solid and secure. The wall must have the capacity to bear the weight of the SMC200HV.

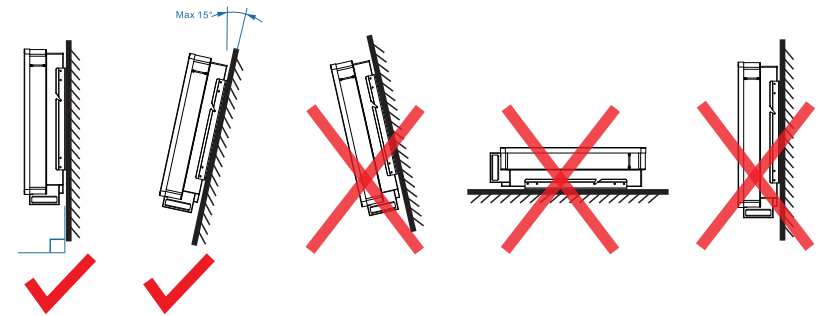

- Space requirements

When installing the SMC200HV, the distance from the top of the SMC to the eaves exceeds 600mm.

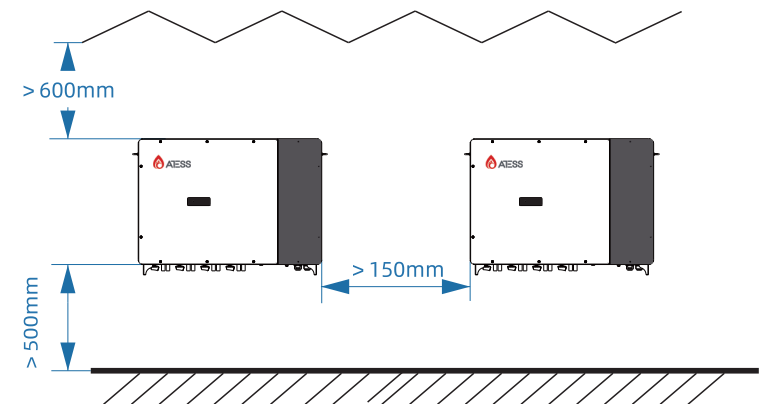



#### Warning!

When the environmental temperature is too high, inverter derating is a normal operation. However, if derating occurs frequently, please check the inverter's heat dissipation surface or consider relocating the inverter to an area with better ventilation. If the fan is dirty, please clean it. If an inverter has an internal fault, please seek professional service.

#### ● Cables requirements

Power cables and communication cables should be placed separately in different cable trenches to prevent them from running parallel over long distances and to reduce electromagnetic interference caused by output voltage transients. The distance between power cables and communication cables should be greater than 0.2m. When the wires are crossed, the crossing Angle should be 90 degrees, and the distance can be appropriately reduced.

#### ● Ventilation requirements

SMC200HV generates heat during operation, and when the ambient temperature is too high, it can affect the electrical performance of the equipment and even damage the equipment, so the release of this heat needs to be fully considered in the design of the control room to ensure the normal and efficient operation of the equipment.

#### ● Ventilation environment

To meet the ventilation requirements of the SMC200HV, the installation environment must meet the following conditions:

- 1.SMC200HV should avoid being installed in places with poor ventilation and low air flow;
- 2.The air intake should have sufficient air supply.

#### ● Ventilation equipment

To ensure the safe, reliable and efficient operation of the equipment, the ambient temperature of the equipment must be within the range of -25 °C to 55 °C. Therefore, appropriate ventilation devices should be provided to dissipate the heat generated by the equipment. It is recommended that the ventilation volume of the SMC200HV installation space be at least 50m<sup>3</sup>/h;

1. The distribution room must be equipped with ventilation facilities to ensure that the waste heat generated by the SMC200HV can be discharged from the equipment to meet the maximum allowable ambient temperature. This can be achieved by installing exhaust devices such as fans, ventilation ducts, etc.
2. To ensure balanced pressure, a fan for outward exhaust can be added at the outlet of the air duct;
3. The direction of the outlet should be chosen according to the actual wind direction of the local area;

4. Pay attention to the dust prevention measures and rain protection design of the air inlets and outlets;

5. If ventilation ducts are needed, the size of the ducts should be based on the volume of air outlet and should be designed by a professional.

#### ● Other protection

SMC200HV has a protection rating of IP65 and is suitable for installation in a dry, clean power plant environment. Also note Avoid water leakage in the house from damaging the SMC200HV. According to EMC requirements and noise levels, SMC200HV should be installed at work in an industrial environment.

## 5.2 Tools and spare parts required for the installation

The tools and parts required for installation are as follows:

- Torque wrench;
- Screwdriver;
- Wire strippers;
- Terminal crimping machine;
- Hot hair dryer;
- Megohmmeter and multimeter.

## 5.3 Mechanical Installation

#### ● Relevant notes

SMC200HV is transported as a whole, and users can lift it from the bottom by forklift or move it by crane or hoist.

#### ● Relevant notes

SMC200HV is transported as a whole, and users can lift it from the bottom by forklift or move it by crane or hoist.

**Note 1:** The SMC200HV is a whole and must not be disassembled either during transportation or installation. Faults caused by unauthorized modifications are not covered by the warranty.

**Note 2:** The SMC200HV should not be tilted, shaken violently or subjected to sudden force during movement, such as sudden lowering or lifting.

**Note 3:** Read the marked parameters carefully to select the appropriate means of transportation and storage location.

**It is recommended that users use forklifts to move the SMC200HV as much as possible.**



Before moving the SMC200HV cabinet to the intended position, it is recommended to lay the DC input and AC power cables first, as these cables are relatively thick and it will be difficult to lay the cables once the SMC200HV cabinet is installed.

In order to ensure that the SMC200HV is in a better state of protection during transportation, transport with packaging as far as possible, and follow the package Loaded with a variety of signs for transport, packaging signs illustrated as follows:

ICONS	A sign
	Face up, no SMC200HV horizontally, tilted, or upside down
	Handle with care to avoid damage to SMC200HV caused by too intense collision friction in the transportation environment
	Take care against moisture to protect your SMC200HV from rain or moisture

The unopened SMC200HV can be moved using a forklift, a crane fork, or a crane. When moving, pay attention to the weight marked on the packaging to ensure that the forklift, crane fork, or crane has sufficient carrying capacity. The center of gravity of SMC200HV is symmetrical front and rear, left and right, and is located at the lower part. During transportation, support or lifting points should be reasonably arranged.

The vehicle transportation method is the standard transportation method. During transportation, the center of gravity of the box should be between the two forks of the forklift. Since SMC200HV is large in size and may block the driver's view, it should be assisted by personnel.

### 5.3.2 Transportation without packaging

#### ● Remove SMC200HV packaging

Please follow the steps below to remove the equipment shipping packing box.

Step 1: Open the upper cover of the packaging carton;

Step 2: Remove the paper corner protectors at the four corners inside the package;

Step 3: Take out the equipment wrapped with pearl cotton.

1) Hold the middle position of the equipment;

2) The equipment can be separated by removing the pearl cotton.

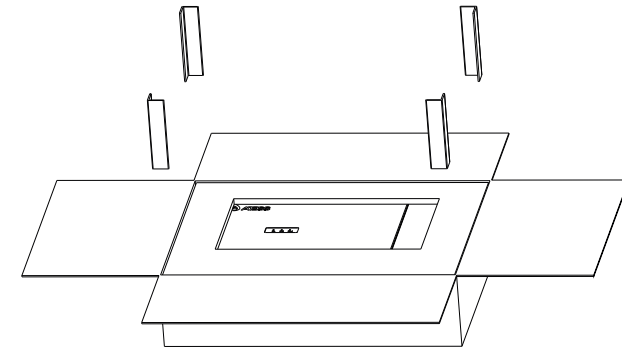

step1

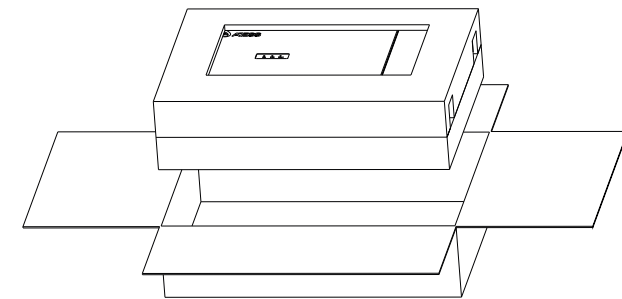

step2

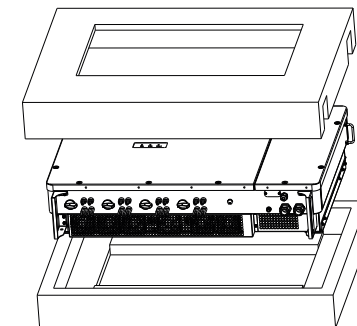

step3

### 5.3.3 Installation of wall-mounting kit



Before installing the wall-mounting kit, please check and make sure there's no electric cable and gas pipe in the location of installation.

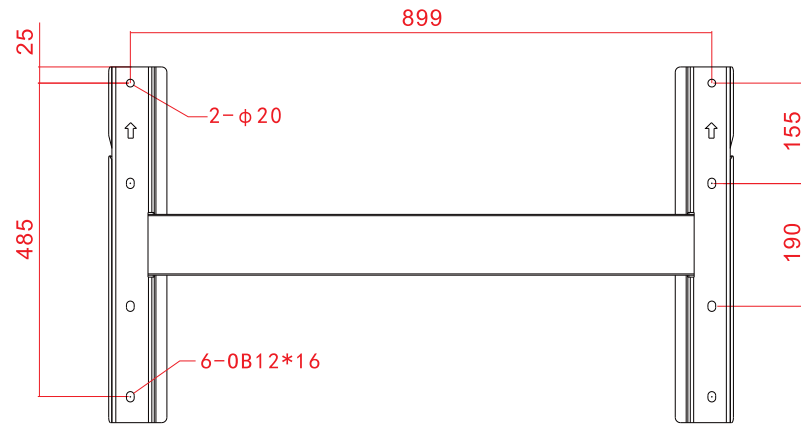

Figure 5-3-3-1 Installation gap

#### Steps:

- A: Please drill the hole according to the hole mask.
- B: Please install the expansion bolt as shown.
- C: Please install the wall hanger as shown in the picture.

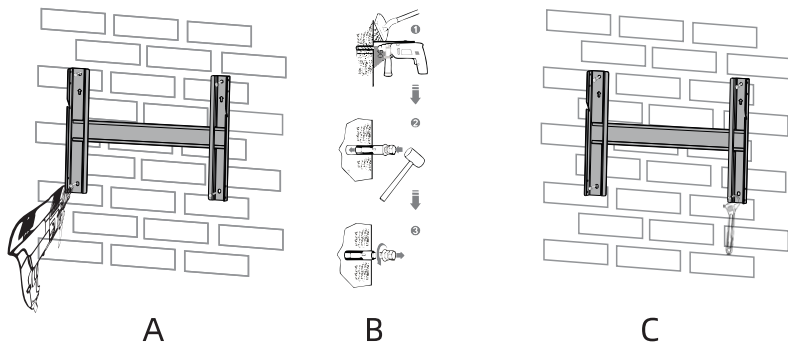

Figure 5-3-3-2 bracket installation



Note: wall-mounting bracket must be installed first before installing SMC200HV

#### ● Move and install the bare machine

SMC200HV that have been unpacked can be lifted and moved by two people. If the unpacking site is a little far from the final installation location, it can be moved with the carton first.

If the SMC200HV cartons have already been removed, during transportation, the center of gravity should be placed between two people before lifting and handling, as shown in the picture below:

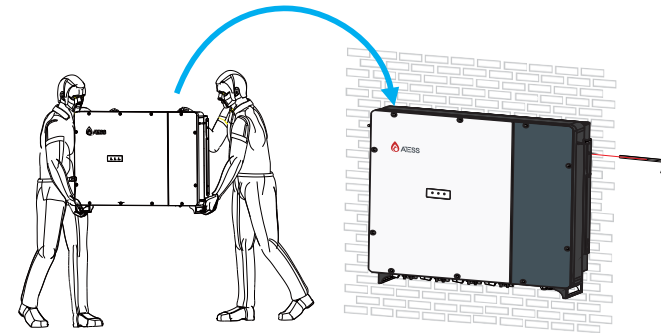

Figure 5-3-3-3 Hanging of SMC200HV

If using the lifting method for movement, pay attention to the lifting position, ensure that the Angle between the lifting Angle lines is less than 70°, and pay attention to the center of gravity position of the SMC200HV.

#### Note:

- Always keep an eye on the center of gravity of the SMC200HV;
- Take necessary auxiliary measures to ensure the safety of transporters;
- Take necessary auxiliary measures to ensure that the equipment is delivered intact to the final installation site.

## 5.4 Electrical Installation

### 5.4.1 Input and Output Requirements

#### Danger!



- There is a high voltage shock hazard when SMC200HV is working, and only electricians with professional skills are allowed to operate SMC200HV.
  - All operations connected to the equipment must be carried out without voltage.
  - If the input and output terminals are connected incorrectly, the SMC200HV will be damaged!
- Failure to follow this warning may result in serious personal injury or significant property damage, or even death.

#### ● Battery assembly

The open-circuit voltage between the positive and negative terminals of the SMC200HV battery assembly should not exceed 850V. If it does, it will put the equipment in an overvoltage protection state and prevent it from functioning properly.

#### ● Cable Requirements

Model	SMC200HV
PV	Bus diameter per route:4mm <sup>2</sup>
Out put	Bus diameter per route:50mm <sup>2</sup>
Ground wire	6mm <sup>2</sup>
Communication wire	Shielded wire: 0.5mm <sup>2</sup>

### 5.4.2 DC side wiring

#### Danger!



SMC200HV only has DC input and output, it is necessary to ensure that the positive and negative poles are not reversed. After determining the polarity with a multimeter, the corresponding positive and negative pole input terminals or output terminals should be connected to the SMC200HV; The internal power supply of SMC200HV is on the upper end of the circuit breaker.

#### The DC side connection method is as follows:

Step 1: Disconnect the upper DC side distribution circuit breaker to ensure that the DC side connection is not live.

Step 2: Use a multimeter to measure the open-circuit voltage of the battery assembly to ensure it is within the allowable range.

Step 3: Use a multimeter to confirm the positive and negative terminals.

Step 4: Remove the insulation at the ends of the cable.

Step 5: Crimp the copper nose of the cable.

1. Insert the stripped copper core part into the crimping hole of the wiring copper nose.

2. Use a terminal crimping machine to press the terminal copper nose tightly. The number of crimping should be more than two.

Step 6: Install the heat shrink tubing.

1. Select a heat shrink tubing that fits the size of the cable, with a length of about 5cm.

2. Insert the heat shrink tubing over the copper nose of the wiring, so that it fully covers the crimping hole of the copper nose of the wiring.

3. Use a hot air blower to tighten the heat shrink tubing.

Step 7: Connect the "Battery-Input +" terminal of the SMC200HV to the positive terminal of the Battery assembly with a cable.

1. Select bolts that match the copper nose of the wiring.

2. Firmly attach the copper noses at both ends of the connection to the "battery-input +" terminal of the SMC200HV and the positive terminal of the Battery assembly respectively.

3. Tighten the bolts with a screwdriver or wrench.

Step 8: Connect the "Battery-input-" end of the SMC200HV to the negative terminal of the Battery assembly with a cable as done in step 7.

Step 9: Connect the "PV-input +" terminal of the SMC200HV to the positive terminal of the photovoltaic module using a cable as in Step 7.

Step 10: Connect the "PV-input -" terminal of the SMC200HV to the negative terminal of the photovoltaic module using a cable as in Step 7.

Step 11: Confirm that the wiring is secure.

### 5.4.3 Grounding wiring

For safety purposes, all SMCS need to be grounded through PE conductors. The PE copper bars inside the SMC200HV cabinet are already reliably connected to the SMC200HV enclosure inside the cabinet. When making the PE connection, the PE grounding copper bars need to be reliably connected to the equipotential bonding device at the installation site or in the electrical control room. The diameter of the grounding cable shall not be less than half of the diameter of the AC output cable, and the grounding resistance shall not be higher than 4Ω.

The connection inlet and outlet should be placed at the bottom of the SMC200HV. After all the connections are completed, the connection inlet and outlet must be sealed with fireproof mud to prevent dust and small animals from entering the SMC200HV interior.



Connect a few connection wires to the PE stud. This is for individual components inside the SMC200HV that need to be grounded. Do not make any changes privately to avoid the danger of electric shock!

## 5.5 Communication

The ATESS SMC200HV series uses multiple communication methods.

### ● RS485. Monitoring plus communication

1. The energy storage controllers communicate with each other via RS485 lines, and finally connect to our company's "Enerlog" and upload to the server via the network, which can remotely monitor the operation status of a single/multiple energy storage controllers in real time. RS485 communication line is made with terminal blocks at both ends, and the terminal blocks at both ends are connected in parallel to make the RS485 communication line. The true length should not exceed 1000 meters. To ensure transmission quality, please use a dedicated twisted-pair shielded communication line. The 485 interface of the energy storage controller is located on the control board inside the machine. Please distinguish between "A" and "B".

2. If Enerlog is not used for monitoring, the user's own monitoring device needs to be compatible with ATESS's 485 communication protocol.

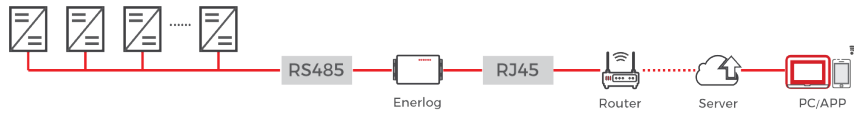

### ● SMC200HV-CAN communication

1. When the energy storage controller is used with the SMC200HV, it needs to communicate with the SMC200HV, the battery is shared, and the PCS and SMC200HV communicate with the SMC200HV's CAN through the PCS' CANB port.

2. SMC200HV and energy storage controller series The communication interface of the energy storage controller is in the same position, please distinguish between "L" and "H", incorrect connection will result in inability to communicate normally.

3. Both ends of the CAN communication line are made with terminal blocks, and the terminal blocks at both ends are connected in parallel to make the CAN communication line. It is recommended to use a dedicated shielded communication line to reduce communication interference and improve the stability of system operation

4. If the user does not use a BMS battery system produced by ATESS, the user's own BMS battery system needs to be compatible with ATESS' BMS communication protocol.

### ● Parallel communication

When used in parallel, connect the CAN interfaces of multiple SMCS using twisted-pair shielded wires.

The parallel function is a special feature. Please enable this function under the guidance of a technician from ATESS.

## 5.6 Single-parallel system wiring with CAN communication wiring

### 5.6.1 Single-machine system wiring

The following is the wiring diagram of a single SMC200HV with a PCS energy storage machine:

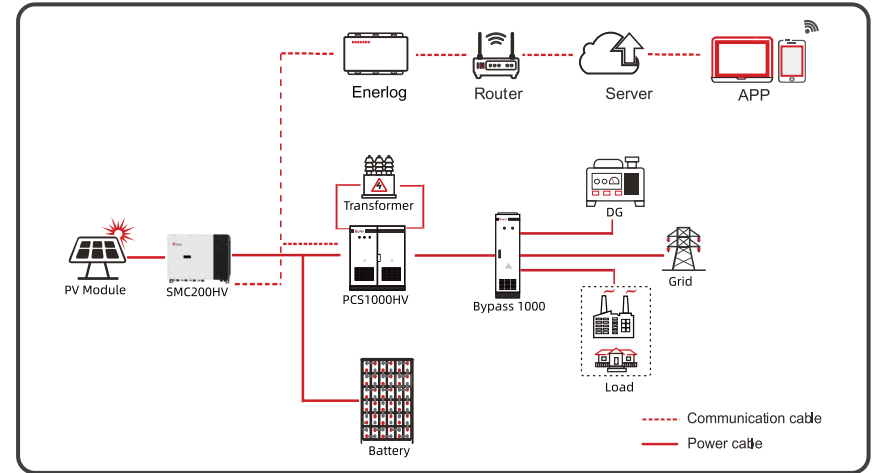

### 5.6.2 Parallel-machine system wiring and CAN communication wiring

The following lists the wiring diagram of a system where 4 SMC200HV units are connected in parallel and 2 PCS units are connected in parallel. The output terminals of multiple SMC200HV units are connected together and then connected to the battery terminal of the PCS.

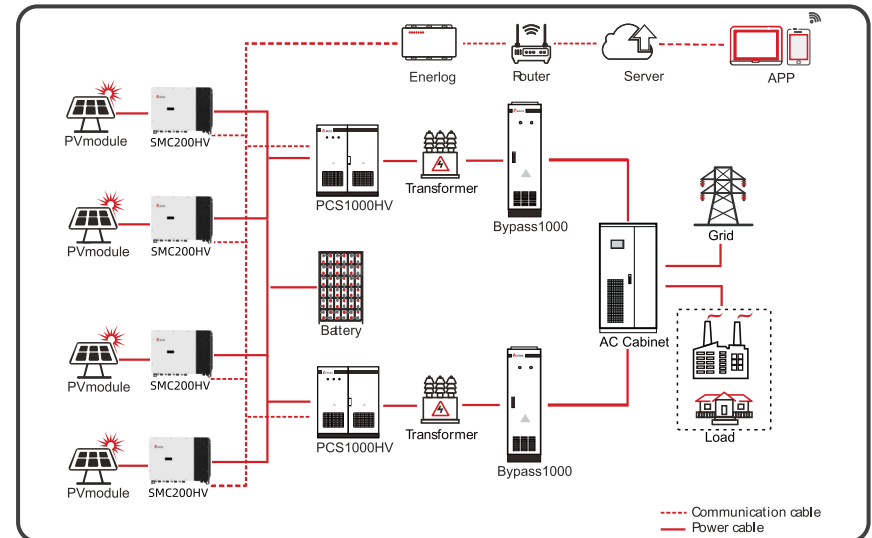

The following figure shows the wiring diagram of CAN communication between the above system, which includes the connection mode and port of CAN communication when multiple SMCS are connected in parallel. If there is only one or more SMC200HV, the CAN connection port remains the same, and the port connected to the PCS remains the same.

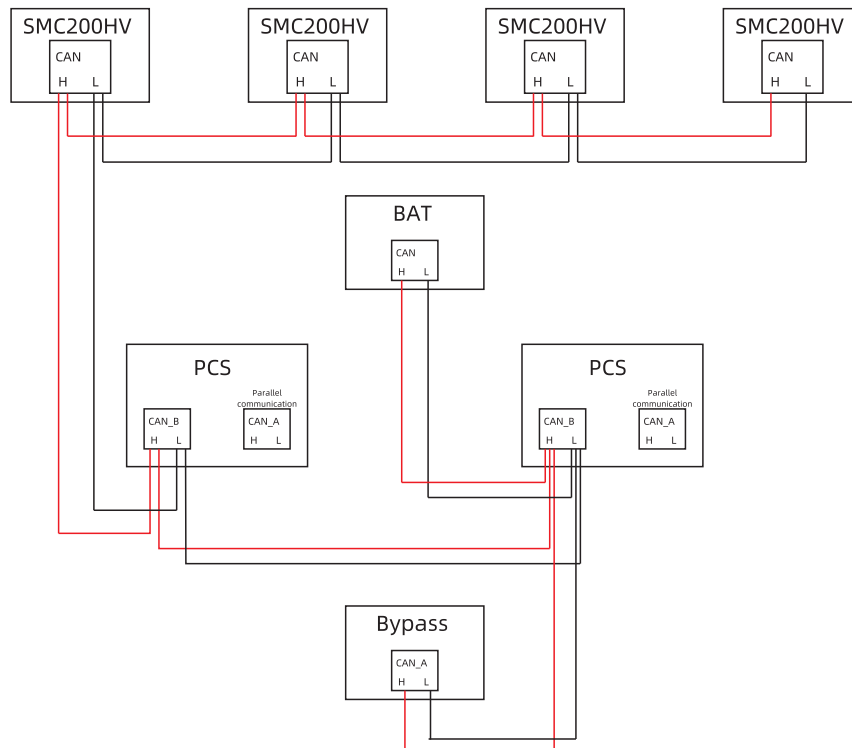

## 6.1 Pre-operation Inspection

Before the SMC200HV is put into operation, its installation should be inspected. At least two staff members should pay attention to the inspection according to the items listed in the table below to ensure the correctness of each installation.

### Mechanical installation item inspection

- SMC200HV shows no deformation or damage
- SMC200HV has a stable and reliable back fixation and support
- There is enough space around SMC200HV
- The temperature, humidity and ventilation conditions of the environment where SMC200HV is located meet the requirements
- The cooling air circulates smoothly
- The cabinet body has complete and reliable sealing protection

### Electrical installation inspection

- SMC200HV grounding is complete and firm
- The PV voltage matches the rated output voltage of the SMC200HV
- The positive and negative poles of the DC input and output connections are correct, and the tightening torque meets the requirements
- The communication wiring is correct and should be kept at a certain distance from other cables
- The cable wire numbers are marked correctly and clearly

### Other checks

- All the useless conductive parts are fastened tightly with insulating cable ties
- There are no remaining tools, parts, conductive dust or other foreign objects from drilling inside the cabinet
- There is no condensed moisture or ice inside the cabinet

## 6.2 Power On

SMC200HV uses DC power supply.

### ● Battery power

Power on to use battery power, close the battery circuit breaker. After powering on, do not start up immediately. Instead, check the fault information page and see if the operation Settings are in line with the actual situation. For details, see Chapter 7.

# 7 Human-machine Interface

## 7.1 Introduction to Touch Screen

The user can view the operating information of the SMC200HV and set the operating parameters of the SMC200HV on the upper computer software. For ease of operation, the logic structure distribution diagram of the upper computer menu is provided below.

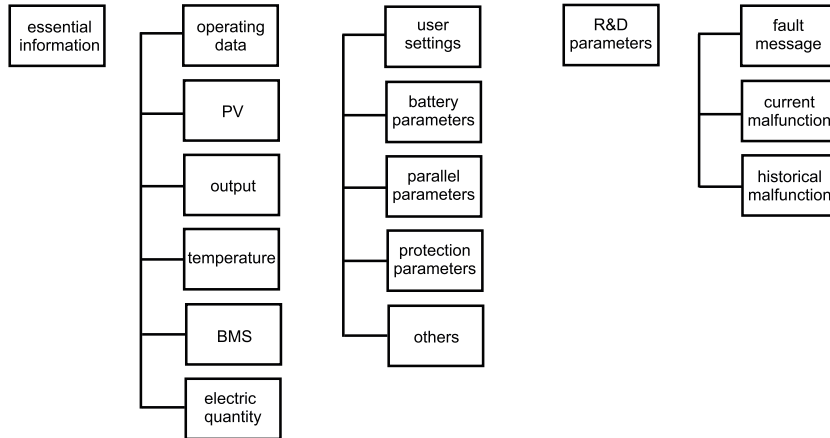

SMC200HV upper computer menu logic structure distribution

After opening the host computer, enter the basic information page. After configuring the serial port, click the OPEN button to connect the machine. After a normal connection, basic information such as the machine's SN number and software version number can be read.

## 7.2 Upper computer operation

### 7.2.1 Device connection

Click the "COM SET" button to configure the serial port. After Setting it up as shown below,click "Setting". Finally click OPEN to connect the device.

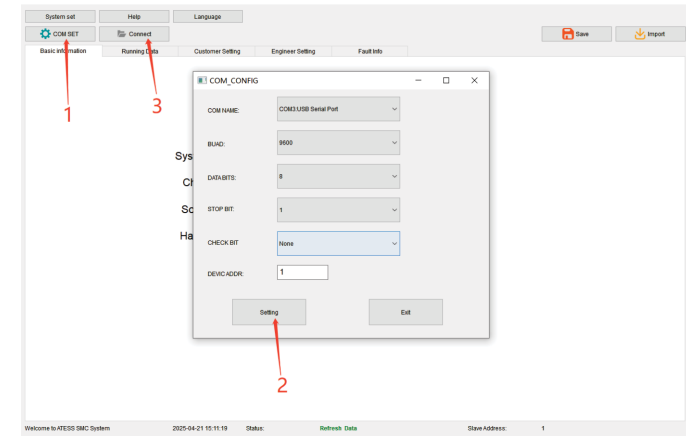

### 7.2.2 Basic Information page

Click the [Basic information] button above any other interface to access this page. This page mainly contains information such as the device's operating status, serial number, detection time system recognition mark, software version, hardware version, etc. Use the [ON] / [OFF] function keys at the bottom of the host computer to choose to turn on or off the device.

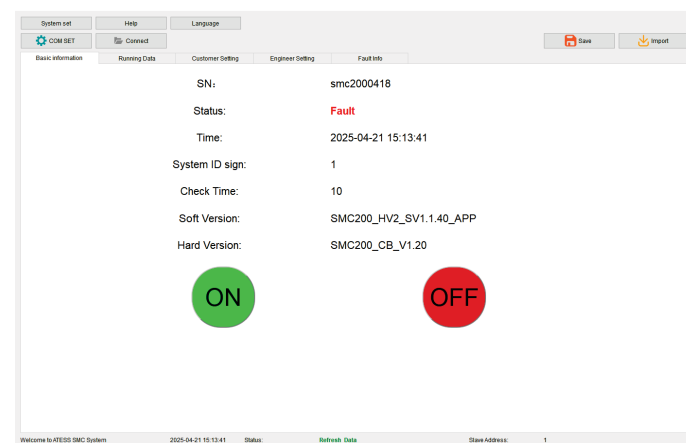

### 7.2.3 Run data

Click the "Running Data" button at the bottom of any other interface to enter the "Running Data" sub-menu.

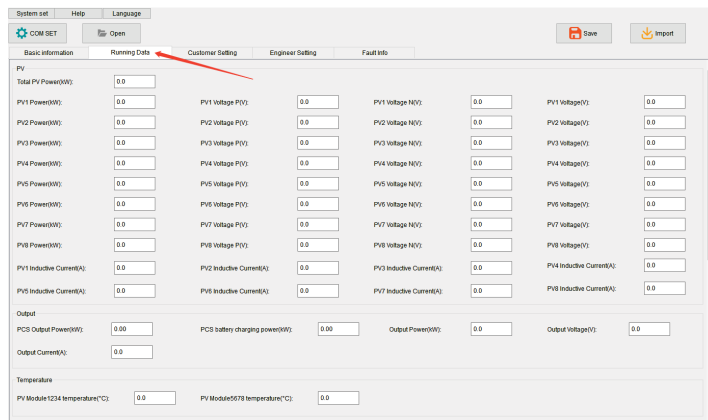

The sub-menus are: PV, Output, Temperature, BMS, Electricity.

**PV:** Displays current energy storage power generation parameters and real-time data including PV voltage and current, PV power, etc. (updated in real time).

**BAT, BUS:** Displays real-time data of the current machine, including battery and bus voltage, battery current, and other information (updated in real time).

**Output:** Displays current output parameters and real-time data including output voltage, output current, and output power, etc. (updated in real time).

**Temperature:** Display current PV module temperature information (updated in real time).

**BMS:** Displays the current cell voltage of the battery.

**Electricity:** Displays parameters related to power generation, including photovoltaic power generation statistics.

### 7.2.4 Customer Settings

Click the [Customer Setting] button on any other interface to enter the "System Settings" sub-menu.

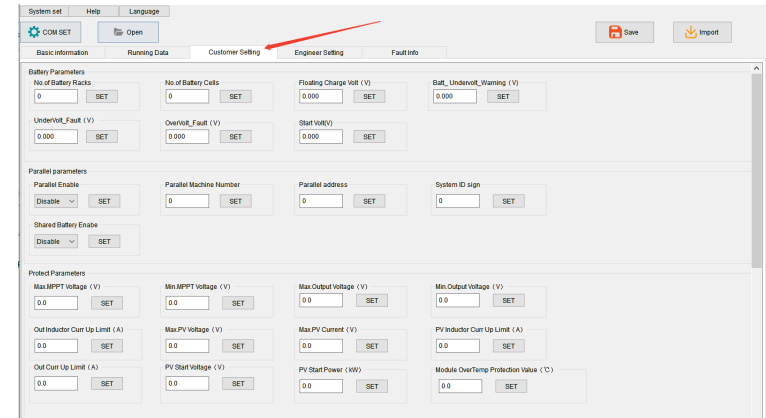

The sub-menu includes: battery parameters, parallel parameters, protection parameters, and other parameters.

#### 1. Battery parameters:

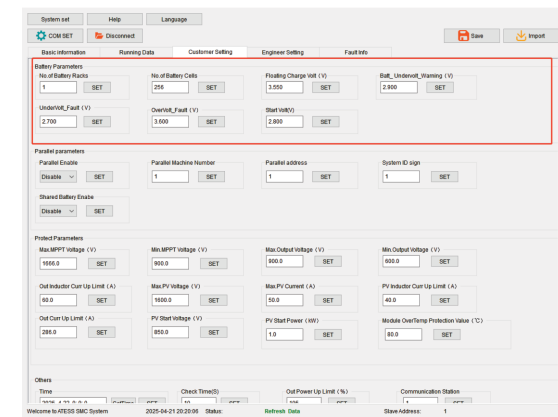

This page is for setting the battery parameters of the machine. Before leaving the factory, this page will be set in accordance with the technical agreement. The battery is an important component of the energy storage control system. The battery parameters need to be carefully confirmed to see if they are consistent with the actual situation. (If they are different from the battery parameters, contact a professional for setting.)

**Battery Group Num:** The number of battery components connected in parallel. For example, 2V/200Ah, 240 in series and 2 in parallel, the number of packs is 2.

**Battery Group Cells:** The number of batteries in each string of the battery assembly. For example, 2V/200Ah, 240 series 2 parallel, the cell count is 240.

**Floating Charge Volt:** The voltage value of the battery's float cell. When the cell voltage reaches this setting, the SMC200HV output power approaches zero.

**Batt\_Undervolt\_Warning:** The cell voltage value at which the battery undervoltage alert occurs. When the battery cell voltage reaches the undervoltage alert point, the SMC200HV gives an undervoltage alert.

**UnderVolt\_Fault:** The cell voltage value during battery undervoltage protection. When the battery voltage reaches this set value, the SMC200HV will protect and shut down.

**OverVolt\_Fault:** The overvoltage unit voltage value of the battery. When the battery voltage reaches this set value, the SMC200HV will protect and shut down.

**Start Volt:** The SMC200HV can start only when the voltage of the SMC200HV cell is higher than the start voltage.

**Shared Battery Enable:** Reserved.

## 2.Parallel parameters:

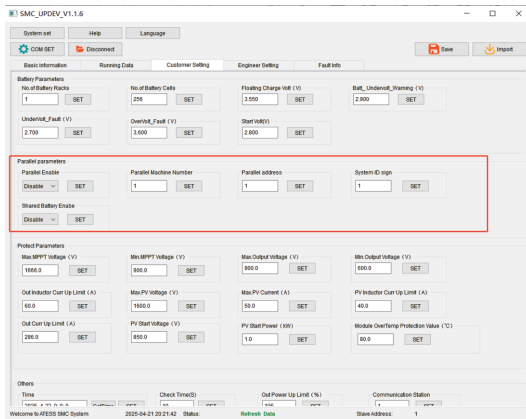

This page sets the parallel parameters for the machine. These parameters are set when the machine leaves the factory. If you need to change them, you should confirm with a professional before making any changes.

**Parallel enable:** When set to 1, it means the parallel function is enabled, and all devices involved in the parallel should be set to 1.

**Parallel Machine Number:** The total number of SMC200HV devices in the system, set 2 for 2 devices and 3 for 3 devices.

**Parallel address:** It is the parallel address at which PCS receives SMC200HV data. No duplicates. The address must be set from 1 and must be consecutive.

**System ID sign:** Background monitoring distinguishes whether devices are part of the same system and uses this to count data. Devices on the same system set the same non-zero number here.

**System Num:** Reserved.

## 3.Protection parameters:

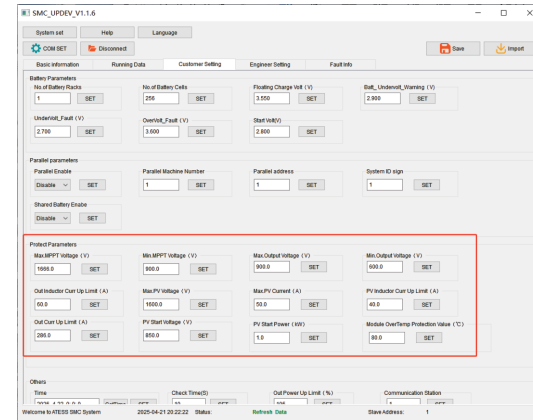

This page sets the protection parameters for the machine. These parameters are set when the machine leaves the factory. If you need to change them, you should confirm with a professional before making any changes.

**Max.MPPT Voltage / Min.MPPT Voltage:** The selection range of photovoltaic voltage, the maximum open-circuit voltage of the PV configuration should be less than the upper limit value, when the PV voltage is less than the lower limit value, the PV output will stop, and the PV panels need to be reasonably configured.

**Max.Output Voltage / Min.Output Voltage:** If the output voltage is above the upper limit or below the lower limit, a fault will be reported and operation will be stopped.

**Out Inductor Curr Up Limit, Out Curr Up Limit:** If the current exceeds the set value, the corresponding fault information will be reported and the machine will stop running.

**Max.PV Voltage:** When PV voltage is higher than this set value, the machine will report a PV overvoltage fault and the machine cannot operate.

**Max.PV Current:** The SMC200HV is set to 55(instantaneous), and when the PV current exceeds the set value,a PV overcurrent fault is reported and the machine stops running.

**PV Inductor Curr Up Limit:** SMC200HV is set to 40 (effective). If the PV inductor current exceeds the set value, a PV inductor overcurrent fault (INT) will be reported and the machine will stop running.

**PV start voltage:** The minimum voltage value for MPPT to track.

**PV start power:** PV is less than that power and the MPPT is restarted for tracking.

**Module over-temperature protection value:** If the module temperature is higher than this set value, the machine will report a PV module over-temperature fault and stop running.

**Max BUS Voltage:** If the BUS voltage exceeds this set value, the unit will report a BUS over-voltage fault and cannot operate.

**4.Other parameters:**

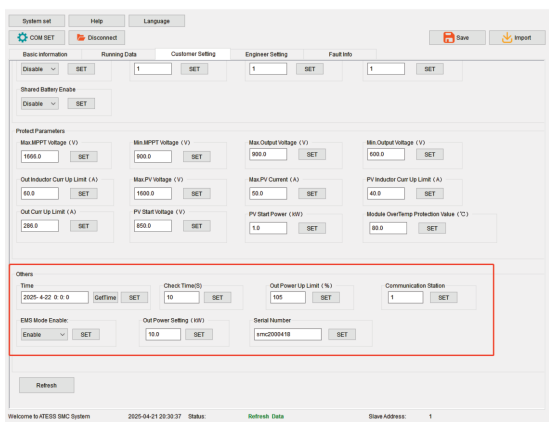

This page sets other parameters of the machine, which are set when the machine leaves the factory and need to be changed with the confirmation of a professional.

**Time setting:** When the machine is turned on, the time needs to be checked. This time determines whether the soft start of the machine is successful. After checking the time, the contactor is engaged, the startup is successful, and it enters the normal working state.

**Check the time:** When the machine is turned on, it is necessary to check the time. This time determines whether the machine has a successful soft start. After the check time ends, the contactor is engaged, the machine is turned on successfully, and it enters the normal working state.

**Out Power Up Limit:** reserved.

**Communication station:** Modify the 485 address when RS485 communication is needed.

**EMS mode enabled:** When enabled, stop the mppt calculation, and the SMC200HV runs in EMS mode with a fixed power output

**Output power setting:** After EMS enable is enabled, the SMC200HV runs EMS mode and the power output by the SMC200HV.

**Serial number:** Device serial number, usually recorded on the machine nameplate.

**Factory Reset Enable:** Power statistics reset.

**CANb baud rate:** Power statistics reset.

**EcerCon Enable:** Must be enabled when the unit is connected to EcerCon.

**Mode:** Selects the unit's operating mode; enable this setting when the PV voltage and battery voltage are similar.

**7.2.5 Development Setting**

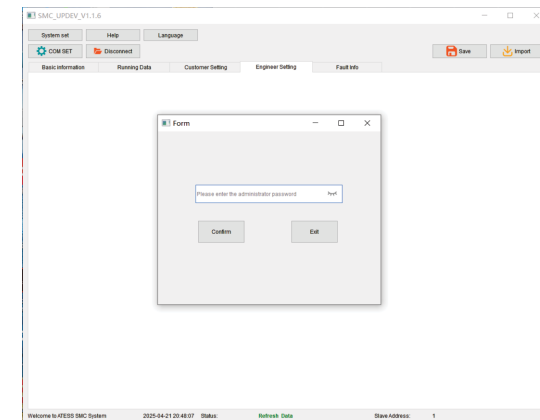

This page is the hidden protection parameter Settings page. Data is an important part of SMC200HV control and is factory preset parameter. Do not modify it without the consent of ATESS personnel.



The page without instructions is factory preset parameter, please do not modify. If the subsequent scheme changes, please modify the parameters under the guidance of ATESS.

**7.2.6 Historical data**

Click the [Fault Info] button at the bottom of any other interface to enter the "Historical Data" sub-menu.

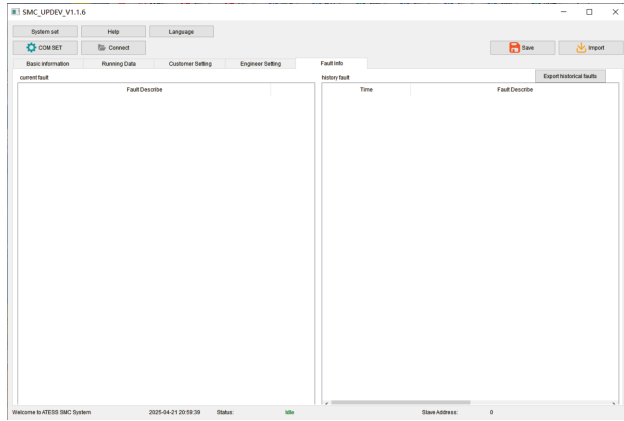

Common historical faults: Swipe up and down the progress bar to view details of all common historical faults. For more common faults information, see Appendix 7.3.

### 7.3 LCD Display Information Schedule

Fault Information Record

No	SMC200HV Fault Information	
	English	Chinese
0	PV_Inverse_Failure	Pv接反永久故障
2	EEPROM_Write_Failure	EEPROM写永久故障
3	EEPROM_Read_Failure	EEPROM读永久故障
8	PV1_VoltHigh_Fault	PV1过压(有效值)故障
9	PV2_VoltHigh_Fault	PV2过压(有效值)故障
10	PV3_VoltHigh_Fault	PV3过压(有效值)故障
11	PV4_VoltHigh_Fault	PV4过压(有效值)故障
12	Batt_OverVolt_Fault	电池单体电压过压故障
13	Batt_UnderVolt_Fault	电池低压故障
16	OUT_OverVolt_Fault	输出(有效值)过压故障
17	OUT_OverCurr_Fault	输出(有效值)过流故障
18	PV_L1_OverCurr_Fault	PV1过流(有效值)故障
19	PV_L2_OverCurr_Fault	PV2过流(有效值)故障
24	INT_PV_L1_OverCurr_Fault	PV1过流(瞬时值)故障
25	INT_PV_L2_OverCurr_Fault	PV2过流(瞬时值)故障
28	INT_PV1_OverVolt_Fault	PV1过压(瞬时值)故障

No	SMC200HV Fault Information	
	English	Chinese
29	INT_PV2_OverVolt_Fault	PV2过压(瞬时值)故障
30	INT_BUS1_OverVolt_Fault	母线过压(瞬时值)故障
31	INT_Out_OverVolt_Fault	输出电压(瞬时值)故障
32	INT_BUS2_OverVolt_Fault	母线过压(瞬时值)故障
33	INT_BUS3_OverVolt_Fault	母线过压(瞬时值)故障
34	INT_BUS4_OverVolt_Fault	母线过压(瞬时值)故障
35	PV_Module1_OverTemp_Fault	PV模块1过温故障
36	INT_OUT_OverCurr_Fault	输出过流(瞬时值)故障
37	INT_PV_L3_OverCurr_Fault	PV3过流(瞬时值)故障
38	INT_PV_L4_OverCurr_Fault	PV4过流(瞬时值)故障
39	INT_BAT_L1_OverCurr_Fault	BAT1过流(瞬时值)故障
40	PV1_P_OverVolt_Fault	PV1正半边过压故障
41	PV2_P_OverVolt_Fault	PV2正半边过压故障
42	PV3_P_OverVolt_Fault	PV3正半边过压故障
43	PV4_P_OverVolt_Fault	PV4正半边过压故障
44	BAT1_P_OverVolt_Fault	BAT1正半边过压故障
45	BAT2_P_OverVolt_Fault	BAT2正半边过压故障
46	BAT3_P_OverVolt_Fault	BAT3正半边过压故障
47	BAT4_P_OverVolt_Fault	BAT4正半边过压故障
48	PV_Module2_OverTemp_Fault	PV模块2过温故障
50	PV_L1_OCP_Fault	PV1_OCP故障
51	PV_L2_OCP_Fault	PV2_OCP故障
52	LowTemp_Fault	低温故障
53	PV_L3_OCP_Fault	PV3_OCP故障
54	PV_L4_OCP_Fault	PV4_OCP故障
55	BAT_L1_OCP_Fault	BAT1_OCP故障
58	LcdEmergencyStop	LCD关机
59	BAT_L2_OCP_Fault	BAT2_OCP故障
60	BAT_L3_OCP_Fault	BAT3_OCP故障

No	SMC200HV Fault Information	
	English	Chinese
61	BAT_L4_OCP_Fault	BAT4_OCP故障
62	Thunder1_Warning	直流1防雷器故障
64	Fault_Feedback_Warning	故障反馈告警
65	Fan_1_Fault_Warning	风扇1故障告警
66	Fan_2_Fault_Warning	风扇2故障告警
67	Fan_3_Fault_Warning	风扇3故障告警
68	Temp_Derating_Warning	过温减载告警
69	Batt_UnderVolt_Warning	电池欠压告警
70	PCS_Communication_Warning	PCS通信告警
71	Batt_UnderVolt_Protection_Warning	电池低压告警
72	Fan_4_Fault_Warning	风扇4故障告警
73	Fan_5_Fault_Warning	风扇5故障告警
74	Fan_6_Fault_Warning	风扇6故障告警
75	Fan_7_Fault_Warning	风扇7故障告警
76	PV1_UnderVolt_Warning	PV1低压告警
77	PV2_UnderVolt_Warning	PV2低压告警
78	PV3_UnderVolt_Warning	PV3低压告警
79	PV4_UnderVolt_Warning	PV4低压告警
80	BAT_L1_OverCurr_Fault	BAT1（有效值）过流故障
81	INT_PV3_OverVolt_Fault	PV3过压（瞬时值）故障
82	INT_PV4_OverVolt_Fault	PV4过压（瞬时值）故障
83	INT_BAT1_OverVolt_Fault	BAT1过压（瞬时值）故障
84	BAT1_VoltHigh_Fault	BAT1电压（有效值）高故障
85	PV_L3_OverCurr_Fault	PV3（有效值）过流故障
86	PV_L4_OverCurr_Fault	PV4（有效值）过流故障
88	PV1_N_OverVolt_Fault	PV1负半边过压故障
89	PV2_N_OverVolt_Fault	PV2负半边过压故障
90	PV3_N_OverVolt_Fault	PV3负半边过压故障
91	PV4_N_OverVolt_Fault	PV4负半边过压故障
92	BAT1_N_OverVolt_Fault	BAT1负半边过压故障
93	BAT2_N_OverVolt_Fault	BAT2负半边过压故障

No	SMC200HV Fault Information	
	English	Chinese
94	BAT3_N_OverVolt_Fault	BAT3负半边过压故障
95	BAT4_N_OverVolt_Fault	BAT4负半边过压故障
96	BAT_L2_OverCurr_Fault	BAT2过流（有效值）故障
97	BAT_L3_OverCurr_Fault	BAT3过流（有效值）故障
98	BAT_L4_OverCurr_Fault	BAT4过流（有效值）故障
99	INT_BAT_L2_OverCurr_Fault	BAT2过流（瞬时值）故障
100	INT_BAT_L3_OverCurr_Fault	BAT3过流（瞬时值）故障
101	INT_BAT_L4_OverCurr_Fault	BAT4过流（瞬时值）故障
102	BAT2_VoltHigh_Fault	BAT2电压（有效值）高故障
103	BAT3_VoltHigh_Fault	BAT3电压（有效值）高故障
107	INT_BAT2_OverVolt_Fault	BAT2（瞬时值）过压
108	INT_BAT3_OverVolt_Fault	BAT3（瞬时值）过压
109	INT_BAT4_OverVolt_Fault	BAT4（瞬时值）过压
110	BAT4_VoltHigh_Fault	BAT4电压（有效值）高故障
112	INT_PV1_VoltUnbalance_Warning	PV1电压（有效值）不平衡告警
113	INT_PV2_VoltUnbalance_Warning	PV2电压（有效值）不平衡告警
114	INT_PV3_VoltUnbalance_Warning	PV3电压（有效值）不平衡告警
115	INT_PV4_VoltUnbalance_Warning	PV4电压（有效值）不平衡告警
116	INT_BAT1_VoltUnbalance_Warning	BAT1电压（有效值）不平衡告警
117	INT_BAT2_VoltUnbalance_Warning	BAT2电压（有效值）不平衡告警
118	INT_BAT3_VoltUnbalance_Warning	BAT3电压（有效值）不平衡告警
119	INT_BAT4_VoltUnbalance_Warning	BAT4电压（有效值）不平衡告警

### 7.3.1 Methods and steps for handling faults

The following are the troubleshooting steps:

1. Look at the screen fault record information.
2. Observe whether the running data on the screen shows any abnormalities.
3. If the running data shows normal, try restarting the screen. Check if the machine can restart. If the machine can restart, it means the fault has been eliminated. If the running data shows abnormal, see if there is a way to measure the actual values and then contact a professional.
4. If Step 3 fails to reboot, you can power the machine back on and then reboot it again.
5. If it cannot be restarted again, it means the fault cannot be eliminated automatically and you need to contact a professional.

**Note:** When the machine malfunctions, the customer needs to keep a clear record of the working conditions of the machine at that time, such as whether the machine is connected to the grid or off the grid, the load capacity, etc. This makes it easier to troubleshoot problems; If the machine has a serious malfunction, such as a circuit breaker tripping, contact a professional and do not restart it.

# 8 Operation

## 8.1 Startup and operation steps

After installation and system setup checks are completed, start up and run.

### ● First run

The first run operation steps are as follows:

1. Close SMC200HV\_PV, battery, Output, and power supply micro-disconnect switch.
2. Check whether the screen sampling data is abnormal and consistent with the actual situation;
3. After confirming that there are no errors, turn the knob switch to "ON", click "Power on" on the LCD "Power On" page, and wait for the machine to enter "running mode";
4. While running, observe whether the data displayed on the screen is normal, whether there is a fault message, and whether the machine has any abnormal noise or odor. If any abnormal situation occurs, stop the machine immediately for inspection.



#### Warnings!

When checking, power will need to be turned off to ensure the machine is not powered, please be careful.

### Manual shutdown

While working, you can click the power OFF button on the LCD or simply turn the knob switch to "OFF" to stop the SMC200HV.



#### Warnings!

1. After manually turning off the LCD by tapping the power button, you must manually turn ON the LCD by pressing the power button (ON); To turn OFF by turning the knob switch to "OFF", first turn the SMC200HV knob switch to "ON", and then click the "Power On" button on the LCD "Power On" page to turn on, otherwise the SMC200HV will not turn on automatically.
2. After manual shutdown, the SMC200HV will still be powered on.

## 8.2 Complete the trial run

After the SMC200HV runs, the following test steps are carried out:

- Step 1: Check the SMC200HV for any abnormalities such as excessive noise, excessive heat generation, unusual odors or smoke;
- Step 2: Measure whether the output voltage and current of the SMC200HV are stable;
- Step 3: Operate the LCD to check if its working display is normal and accurate;
- Step 4: Test if it fits the preset operating logic.

At this point, the trial operation process of SMC200HV has been fully completed and it can now enter the daily operation and maintenance process.

## 8.3 Shutdown and power-off steps



#### Warnings!

After the SMC200HV is completely powered off, the SMC200HV remains live. If you need to operate, be sure to completely disconnect all external connections and wait for at least 5 minutes.

1. Turn the knob switch to "OFF" to turn off the power.
2. Disconnect the DC main input switch PV input and Battery input;
3. Disconnect the output switch output



#### Warnings!

It is normal for the SMC200HV to give an alert during the power-off process and proceed with the power-off step.

# 9 Product Maintenance

## 9.1 Routine Maintenance

### 9.1.1 Maintenance and repair



All maintenance and repair operations on the SMC200HV may only be carried out when the SMC200HV is safely disconnected from the photovoltaic modules, battery modules, and grid, and when it is confirmed that these power sources will not be reconnected and at least 5 minutes or more have been waited.

Such operations can only be carried out by professional technicians who are familiar with system operations.

#### ● Disconnect the circuit breaker

Operate the PV input and Battery input DC switches to disconnect the SMC200HV from the photovoltaic module and the battery module, and operate the output switch to disconnect the SMC200HV from the outside. Make sure the SMC200HV is not accidentally reconnected. Test with a multimeter to ensure that the device is disconnected and there is no voltage. Even if the SMC200HV is disconnected from the main power supply and the battery and photovoltaic module, some components inside the SMC200HV (such as capacitors) still have residual voltage and discharge slowly. Therefore, after the circuit breaker is disconnected, please wait at least 5 minutes and use a multimeter to measure and confirm safety before proceeding.

#### ● Maintenance and modification

Only authorized personnel of Times Energy Technology are allowed to maintain and modify SMCS. For personal safety, please use only original factory parts provided by the manufacturer. If non-original parts are used, there will be no guarantee of compliance with relevant certification criteria in terms of electrical safety, EMC, etc.

#### ● Functions and safety parameters

Do not change the parameters of the SMC200HV without authorization from the local power supply company and without instructions from Times Energy Technology. Changing the functional safety parameters without authorization may cause injury or damage to a person or the SMC200HV. In such cases, Times Energy will not provide warranty services.



**Attention!**  
After power-off, wait for 5 minutes to confirm safety before proceeding with the repair work.  
Use a multimeter to measure and ensure safety before proceeding with disassembly and assembly.

### 9.1.2 Replacing the air filter

During the use of the SMC200HV, the top dust should be cleaned regularly, and the dust screen at the air inlet should be cleaned or replaced. During the replacement of the dust screen, the SMC200HV needs to be powered off.

Dust screen replacement method: The dust filter cotton on the door panel can be pulled out directly upwards for cleaning and replacement.



In order to ensure the normal operation of SMC200HV, the air filter needs to be cleaned regularly.

### 9.1.3 Perform regular maintenance

SMC200HV must undergo regular maintenance work to ensure its normal operation and service life. The recommended routine maintenance cycles and tasks are shown in Table 7-2.

Maintenance Items	Cycles
Read the data from the data collector	Monthly
Clean the power module radiator	Monthly
Check the inside of the cabinet for dust, moisture, or condensation	Monthly
Check for loose cable connections and tighten screws if necessary	Monthly
Check warning labels and add or replace them promptly if necessary	Monthly
Manually inspect AC/DC circuit breakers	Monthly
Check the emergency stop button as well as the stop function of the LCD	Monthly
Check the machine for abnormal noises during operation	Weekly
Check the battery assembly for abnormalities, bulges, and smoke	Daily

Table 7-2 Routine maintenance tasks of periodic machines



All maintenance operations must be carried out on the DC side of the SMC200HV with all the corresponding switches of the battery assembly open.  
After the SMC200HV DC switch is disconnected, some components on the SMC200HV still have residual voltage. Please wait at least 5 minutes before performing maintenance operations on the SMC200HV.

## 9.2 Waste Disposal

SMC200HV does not cause pollution to the environment. The materials and components of the product meet environmental protection requirements. Times Energy Technology, in accordance with environmental protection requirements, users should handle the SMC200HV in accordance with local relevant regulations at the end of its service life.

# 10 Appendix

## 10.1 Product Specifications

SMC200HV has no battery itself, and the output is connected to the PCS DC side or battery;

Specification parameters	SMC200HV
Maximum PV power (KW)	200
MPPT Voltage range (V)	900-1300
Maximum input current (A)	160 (20*8)
MPPT quantity	8
Rated PV power	180kW

**Note:** When configuring the photovoltaic and battery of the SMC200HV, pay attention to the voltage range of the rear stage to avoid burning out the controller.

## 10.2 ATESS Factory Warranty

### ●Warranty period

The warranty period of SMC200HV is one year. If otherwise specified in the contract, the contract shall prevail.

During the warranty period, the customer shall show the invoice and date of purchase to the service personnel of ATESS. At the same time, the nameplate mark on the product shall be clear and visible, otherwise, ATESS has the right not to provide warranty service.

### ●Warranty conditions

In the event of failure during the warranty period, ATESS will repair or replace the product free of charge; The customer shall Set aside some time to repair the faulty machine.

### ●Liability exemption

In case of the following circumstances, ATESS has the right not to conduct warranty:

1. Products without logo of ATESS Power Technology logo.
2. The product or component that has exceeded the valid warranty period of ATESS.
3. Failure or damage(such as high temperature, low temperature, too wet or dry, high altitude, unstable voltage or current, etc.) caused by working in beyond-specified environment or wrong installation, storage or use that violates the instructions.
4. Failure or damage caused by unauthorized installation, repair, modification or disassembly, except for those authorized by ATESS.
5. Failure or damage caused by using components that not supplied by ATESS.
6. Failure, damage or transportation damage caused by accident or human factors (operation error, scratching, carrying, bumping, improper voltage connection etc.).
7. Failure or damage caused by force majeure (such as earthquake, lightning, fire etc.).
8. Failures or damages caused by other factors rather than quality problems of the supplied product itself(including components).