







HPS100KTL

HPS125KTL

100-125kW three phase all-in-one hybrid inverter for small commercial use.

Features

-  IP65 waterproof design
-  Higher Single-unit Output Power
-  All-in-one hybrid inverter, ATS function inbuilt
-  Seamless on/off grid transfer within 10 ms
-  Max. 10 units in parallel for on&off grid operation
-  Support remote control of DG
-  Programmable working mode
-  Multiple MPPT inputs



Block Diagram

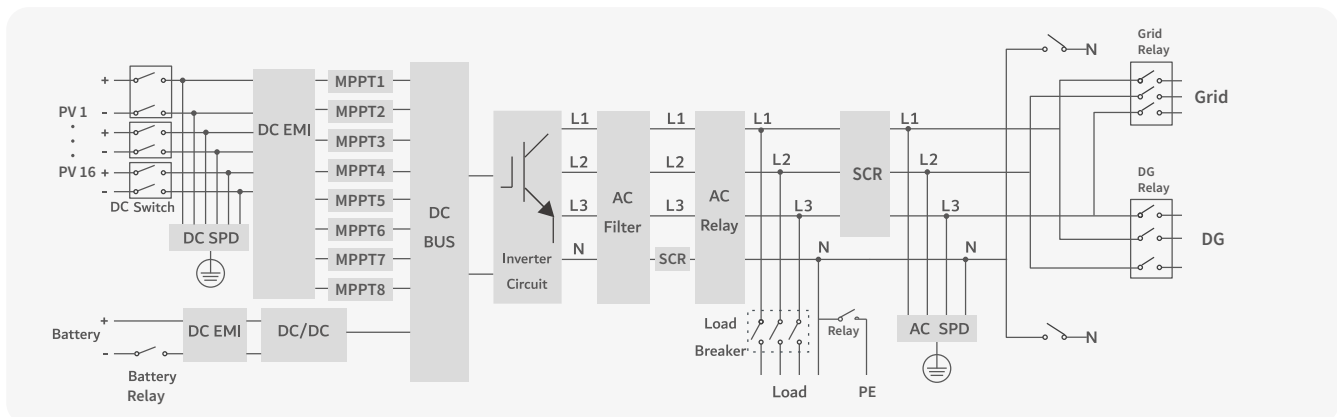

HPS100KTL**HPS125KTL****AC(on-grid)**

Apparent power	100kVA	125kVA
Rated power	100kW	125kW
Rated voltage	220/380Vac, 230/400Vac	220/380Vac, 230/400Vac
Rated current	144A	181A
Voltage range	196-253Vac/340-440Vac	196-253Vac/340-440Vac
Rated frequency	50/60Hz	50/60Hz
Frequency range	45~55/55~65Hz	45~55/55~65Hz
THDI	<3%	<3%
PF	0.8 lagging~0.8 leading	0.8 lagging~0.8 leading
AC connection	3L/N/PE	3L/N/PE
Max. AC input power	150kW	187.5kW

AC(off-grid)

Apparent power	100kVA	125kVA
Rated power	100kW	125kW
Rated voltage	400V	400V
Rated current	144A	181A
THDU	≤2% linear	≤2% linear
Rated frequency	50/60Hz	50/60Hz
Overload capability	120%-10 mins 130%-1 min 150%-10s	120%-10 mins 130%-1 min 150%-10s

DC (Battery and PV)

Max. PV Open-circuit voltage	1000V	1000V
Max.PV access power	200kWp	250kWp
Max.PV input power	150kWp	187.5kWp
PV MPPT voltage range	125V-850V	125V-850V
Number of MPPT	6	8
PV input/MPPT	2/2/2/2/2/2	2/2/2/2/2/2/2/2
PV input current	40/40/40/40/40/40A	40/40/40/40/40/40/40/40A
Max. PV Isc	60/60/60/60/60/60A	60/60/60/60/60/60/60/60A
Max. PV Isc/Channel	20A	20A
Battery voltage range	150-950V	150-950V
Full load battery voltage range	500-950V	500-950V
Max. charge/discharge power	100kW	125kW
Max. charge/discharge current	200A	200A

General Information

Max. efficiency	97.6%	97.6%
Protection degree	IP65	IP65
AFCI Function	Optional	Optional
Noise emission	<65dB(A)@1m	<65dB(A)@1m
Operating temperature	-40 °C~+60 °C	-40 °C~+60 °C
Cooling method	Intelligent air cooling	Intelligent air cooling
Relative humidity	0-100% non-condensing	0-100% non-condensing
Max. altitude	5000m (derate over 3000m)	5000m (derate over 3000m)
Dimension (W/H/D)	960/680/300mm	960/680/300mm
Weight	138kg	138kg
Topology	Transformerless	Transformerless
Lightning protection	Type II	Type II
Transfer between on/off grid	Automatic≤10ms	Automatic≤10ms
Standby consumption	<50W	<50W

Communication

Display	Touch screen	Touch screen
Communication	RS485/CAN/WiFi/4G(optional)	RS485/CAN/WiFi/4G(optional)