



SHENZHEN ATESS POWER TECHNOLOGY CO.,LTD

GROWATT-ATESS Industrial Park, No.23 Zhulongtian Road, Shuitian Community,
Shiyan Street, Baoan District, Shenzhen

Tel: +86 755 2998 8492

Web: www.atesspower.com

Email: info@atesspower.com

Revised date: 2026-05-06

HPS15000TL/20000TL/30000TL

Hybrid Energy System
User Manual

Contents

1 About this Manual

- 1.1 Contents
- 1.2 Symbols explanation

2 Safety Instructions

- 2.1 Correct installation
- 2.2 Operator
- 2.3 Inspection and storage
- 2.4 Transportation
- 2.5 Installation
- 2.6 Repair and maintenance
- 2.7 Inverter EMC and noise level
- 2.8 Important note

3 Product Description

- 3.1 Energy Storage system
- 3.2 Circuit diagram of the inverter
- 3.3 Product specification
- 3.4 The layout of the main parts
- 3.5 Working mode
- 3.6 Battery setting
- 3.7 Storage
- 3.8 Packaging information

4 Products Installation

- 4.1 Installation Condition Requirements
- 4.2 Installation environment
- 4.3 Space requirement
- 4.4 Tools for installation
- 4.5 Machine installation
- 4.6 Electrical installation
- 4.7 Communication
- 4.8 Installation inspection

5 Pilot operation

- 5.1 Relevant requirements
- 5.2 Inspection
- 5.3 Power on steps
- 5.4 Pilot operation completion
- 5.5 Power off steps

6 GUI Instrution

- 6.1 Introduction to touch screen
- 6.2 Touch screen operation
- 6.3 LCD display information schedule

7 Routine Maintenance

- 7.1 Fan maintenance
- 7.2 Regular maintenance
- 7.3 Waste treatment

8 Appendix

- 8.1 Specification
- 8.2 Warranty

1 About this Manual

This chapter describes the contents of this manual, target reader, and safety symbols, can help users to have a better understanding of the manual.

1.1 Contents

This manual applies to ATESS HPS15000TL/HPS20000TL/HPS30000TL hybrid energy system, the manual contains:

Safety instruction

Attention that needs to be paid when operating and maintaining ATESS HPS15000TL/HPS20000TL/HPS30000TL

Product description

The role inverter plays in the energy storage system and structure, principle, protection, operation mode, storage and package size of the ATESS HPS15000TL/HPS20000TL/HPS30000TL.

Installation

Inverter installation conditions, tools, and the inverter mechanical and electrical installation, the communication connection and inspection.

Commissioning

Inspection before commissioning and procedure to turn on/off inverter.

HMI

Information displayed on the inverter LCD touch-screen and setting instruction.

Routine maintenance







Daily maintenance of the inverter, the replacement of some spare parts and waste disposal instruction.

Appendix

Technical data, warranty policy and contact information.

1.2. Symbols explanation

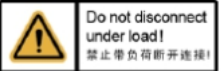
In order to ensure the personal and property safety of the user during installation, or optimally efficient use of this product, symbols are used highlight the information. The following symbols may be used in this manual, please read carefully, in order to make better use of this manual.

Symbol	Symbol name	Implication
	Caution, risk of electric shock	This inverter contains high voltage during operation. All relative operations must be proceeded by the professional electricians.
	Delay discharge	There will be residual voltage in the inverter, it takes 5 mins to completely discharge.
	Overheated	It's forbidden to touch the shell of inverter during running due to overheating.
	Refer to user manual	A reminder for the operator to check the user manual that goes with the inverter.
	PE terminal	Connect the inverter with PE terminal for earthing protection
	Operation warning	Do not take off the DC input connected directly when the inverter is running
	CE certified	This product is complied with CE certification standard.

2 Safety Instructions

Inverter installer and service personnel must be trained and familiar with the general safety requirement when working on electrical equipment. Installer and service personnel should also be familiar with the local laws and regulations and safety requirements.

- Read this manual carefully before operation. The equipment will not be under warranty if failing to operate according to this manual.
- Operation on the inverter must be for qualified electrical technician only.
- When inverter operating, don't touch any electrical parts except for the touchscreen.
- All electrical operation must comply with local electrical operation standards.
- Warranty service for the inverter does not contain module maintenance.
- Permission from the local utility company is required before installing the Energy Storage system and only professional personnel are qualified for the operation.

2.1 Correct installation

Proper installation requires following all the instructions in the user manual involving transportation, mounting, wiring and commissioning. ATESS does not cover warranty for the inverter damage due to improper use.

- Note the instruction in this chapter and after
- Follow the manual
- Refer to relevant data and technical spec

2.2 Operator

Inverter installer and service personnel must be trained and familiar with the general safety requirement when working on electrical equipment. Installer and service personnel should also be familiar with the local laws and regulations and safety requirements.

2.3 Inspection and storage

The inverter should be carefully checked before signing the document from the transportation company. Check the received items against delivery note, and if there is any defect or damage, immediately notify the transportation company. If necessary, you can seek help from ATESS Customer Service department.



Note:

ATESS HPS15000TL/HPS20000TL/HPS30000TL can only be stored when it is stopped and all the doors are closed in a dry room to protect the internal circuits against dust and moisture.

2.4 Transportation

Transportation should follow the transportation methods described in the user manual. The inverter's weight and center of gravity should be taken into account during transportation. The center of gravity is marked on the box.



Caution, risk of danger

During transportation, lifting equipment and personnel must be qualified. The inverter should be placed vertically and the inclination cannot be more than 10 degrees. It is not allowed to place the inverter upside down or transport in a horizontal position. Incorrect lifting and transportation can lead to serious injury, property loss and damage to the inverter.

2.5 Installation

Hybrid storage inverter is with IP65 protection level, and designed for wall-mounting installation, installation of the inverter must be according to information included in this manual especially on Chapter 4.

2.6 Repair and maintenance



Repair and maintenance can only be carried out after disconnecting the DC and AC for at least 5 minutes. Only professional technical personnel are qualified for the operation.

Disconnect breaker

Open PV and BAT switch to disconnect inverter from battery and solar array, and open GRID input and GRID output switch to disconnect inverter from grid. Make sure inverter cannot be connected accidentally. Test with multi-meter and make sure all switch and breaker open and without voltage potential. Even inverter is disconnected from grid and battery, PV, some component inside inverter such as capacitor is still with energy stored and is dangerous when capacitor discharge, so at least 20 minutes later check with multi-meter that BUS line is without voltage potential, then operate accordingly.

Maintenance and modification

Only personnel with ATESS authorization are qualified for the maintenance and modification. And to ensure personal safety, use original accessories provided by the manufacturer only. Otherwise, electrical safety and EMC might not comply with the required standard.

Function and safety parameters

Don't change the parameters of the inverter without authorization from the local utility and ATESS Energy Technology Co., Ltd. Otherwise, it might lead to injury or equipment damage and the warranty of the inverter will be voided.

2.7 Inverter EMC and noise level

Electromagnetic compatibility (EMC) is the requirement for electrical equipment that it can operate normally in the electromagnetic environment and does not cause unacceptable environmental impact itself. So EMC represents the quality characteristics of electrical equipment:

Hybrid inverter can generate certain noise and electro-magnetic radiation, according to EMC and noise level, the inverter is qualified for installation and operation in industrial environment, long time stay around the inverter is not recommended during operation.

2.8 Important note

Information

Note 1: Static electricity can cause damage to the inverter

Electrostatic discharge may cause unrecoverable damage to inverter internal components! When operating the inverter, operator must comply with anti-static protection regulations!

Note 2: Restriction

The inverter cannot be directly used to connect the life support equipment and medical equipment!

Item 3: Precautions

Make sure installation tools or other unnecessary items are not left inside the inverter before starting up.

Item 4: Maintenance notice

Maintenance can only be carried out after the inverter totally discharged.



3 Product Description

3.1 Energy Storage system

ATESS HPS15000TL/HPS20000TL/HPS30000TL hybrid inverter is designed for energy storage system, it converts DC current generated by battery bank into AC current and feed into the load/grid, also it can take power from solar inverter or grid to charge battery .

3.2 Circuit diagram of the inverter

ATESS HPS15000TL/HPS20000TL/HPS30000TL hybrid inverter is designed for energy storage system, it converts DC current generated by battery bank into AC current and feed into the load/grid, also it can take power from solar inverter or grid to charge battery .

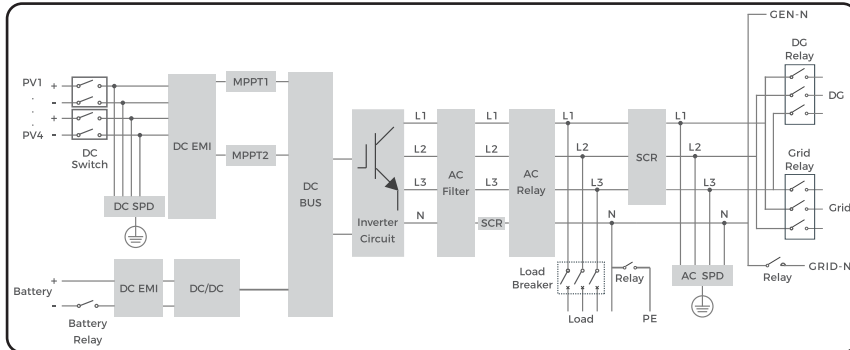

Figure 3-2-1 ATESS HPS-TL circuit diagram

3.3 Product specification

3.3.1 Input parameter

Inverter model	HPS15000TL	HPS20000TL	HPS30000TL
Max. PV power	22.5kW	30kW	45kW
Max. PV open-circuit voltage	1000V	1000V	1000V
PV MPPT voltage range	125V-850V	125V-850V	125V-850V
Bat input voltage range	150V-700V	150V-700V	150V-700V
Bat Max.charge/ discharge current	50A	66A	75A
AC Input Max Power (Gen and Grid)	22.5kW	30kW	45kW

3.3.2 Output parameter

Energy storage controller model	HPS15000TL	HPS20000TL	HPS30000TL
Rated AC output power	15kW	20kW	30kW
Rated AC output current	21A	28A	43A
Rated AC output frequency	50/60HZ		
Rated AC voltage	400V		
Power factor	0.8lagging-0.8leading		

3.3.3 Important notes

Note1: Usage restrictions



- A. If the load connected to the inverter is a motor and the output voltage waveform is not distorted, then HPS15000TL/20000TL/30000TL can only drive a 3HP motor.
- B. If you want the HPS to drive more motors, you need to connect the inverter between the HPS and the motor



3.4 The layout of the main parts

3.4.1 External layout



Figure 3-4-1-1 Inverter appearance

No.	Name	Description
1	Display	Inverter setting, browsing and operation status display
2	Cable inlet and outlet	For input and output power cable connection
3	Heat dissipation screen	For hot and cool air ventilation

Cable inlet and outlet

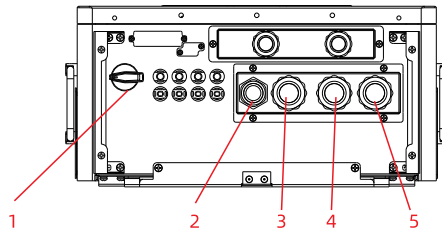
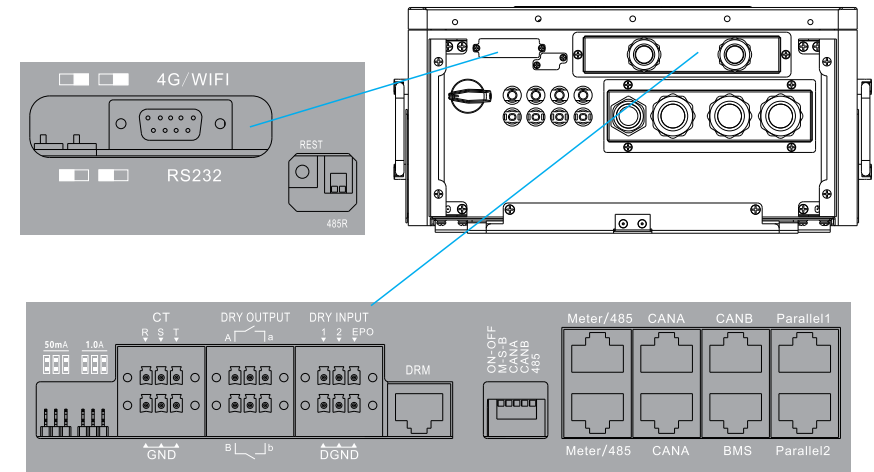

Figure 3-4-1-2 Inverter cable inlet and outlet

No.	Port	Description
1	SWITCH I	PV DC switch
2	BAT	BAT cable gland
3	Load	Cable gland for Load output
4	Grid	Cable gland for Grid output
5	GEN	Cable gland for GEN output

Communication port



SWITCH Details

No.	Name	Description
1	ON-OFF	Parallel matching resistance (120 Ω)
2	M-S-B	Parallel matching resistance (120 Ω)
3	CANA	CAN matching resistance (120 Ω)
4	CANB	Parallel matching resistance (120 Ω)
5	485-A	Meter/485 matching resistance (120 Ω)

RJ45 terminal

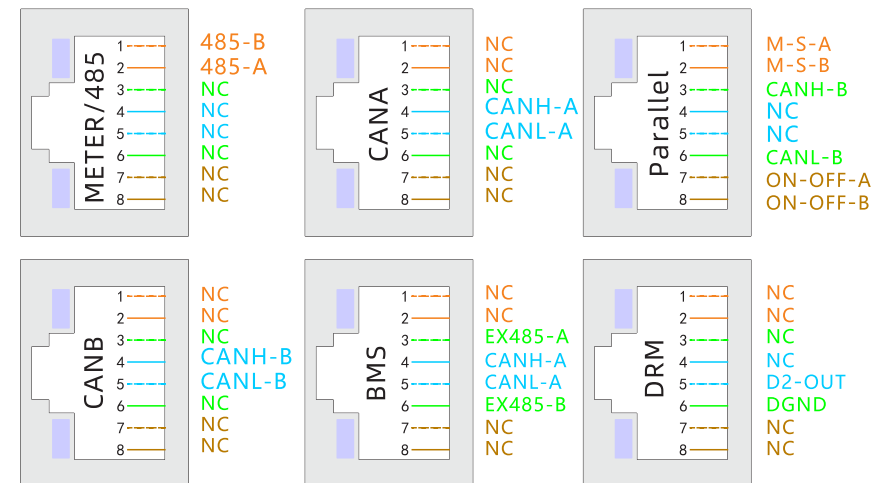

3.4.2 Inner component layout

DC/AC breaker

HPS15000TL/HPS20000TL/HPS30000TL doesn't have AC and DC switches or load switches, customers need to add their own switches, or buy our company to design and produce switch boxes.

The AC main switch can be used to disconnect the AC interface of the inverter from the grid. The DC main switch can be used to make the DC interface of the inverter disconnected from the battery assembly. If you use AC main breaker under load, the components of the inverter will be subjected to considerable stress. Frequent use of the AC main switch can result in individual components damage due to stress and may cause inverter failure.

3.5 Working mode

HPS15000TL/HPS20000TL/HPS30000TL is designed with flexible working modes:

3.5.1. Off-grid mode

When the PV power is greater than the load power, the PV gives priority to the load and the remaining power charges the battery.

When the PV power is less than the load power, the battery discharges automatically. If the battery discharges to the undervoltage protection point, the HPS stops the AC output and transfers to the PV charging mode only, and the battery is charged to a certain level and resumes discharging.

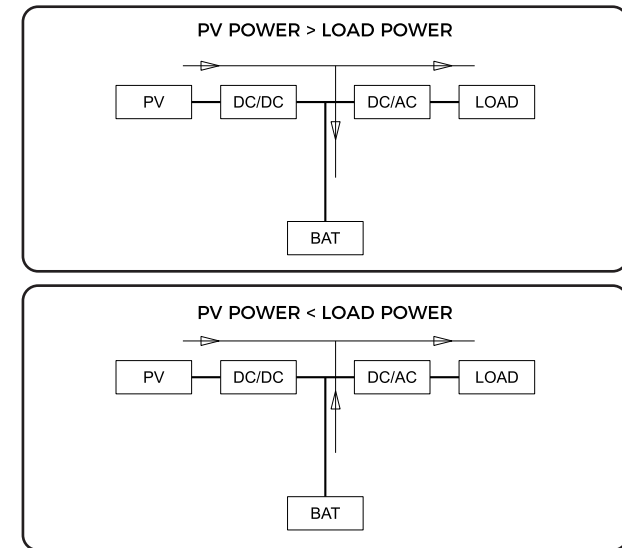

3.5.2 Grid-connected load priority mode

● PV POWER > LOAD POWER

When the PV power is greater than the load power, the PV gives priority to the load and the remaining power charges the battery.

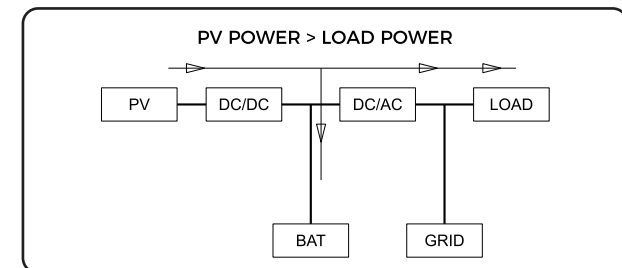

● PV POWER < LOAD POWER

Automatic battery discharge. If the battery is discharged to the undervoltage protection point, the PV and the grid together to the load power supply, in order to protect the battery, will use small power energy to the battery trickle charging, the battery charging to a certain level can be restored to the power supply.

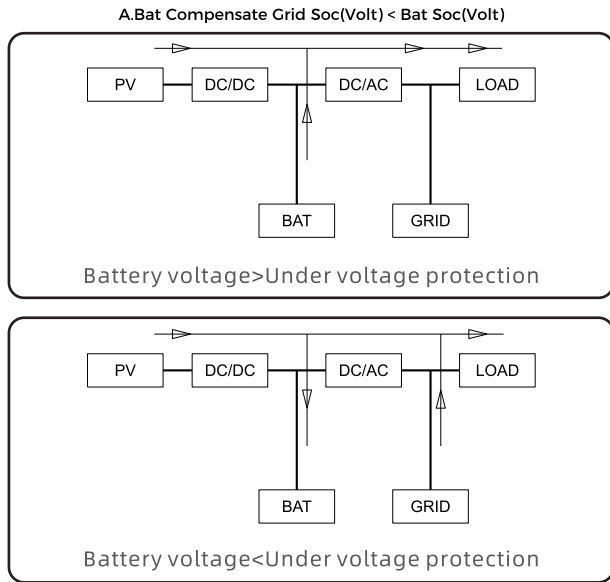

Grid discharge with load.

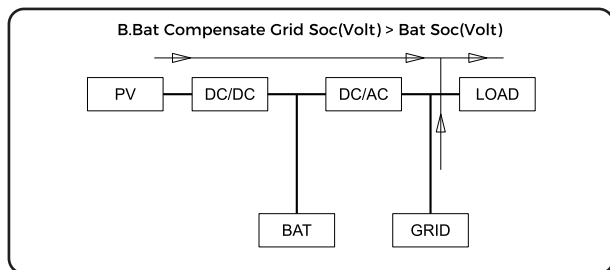

3.5.3 On-grid backup priority mode

Grid-connected battery priority mode

When the PV power is greater than the charging power, the PV gives priority to charging the battery and the surplus power is supplied to the load;

When the PV power is less than the charging power, the PV prioritises charging the battery and the grid supplies the load, while the grid also charges the battery.

If the grid-connected backup mode is not discharged or switched to other modes, in order to maintain the electrochemical activity of the battery, current-limited charging for one week, and then enter the battery discharge state, the battery discharge power is 20% of the rated output power.

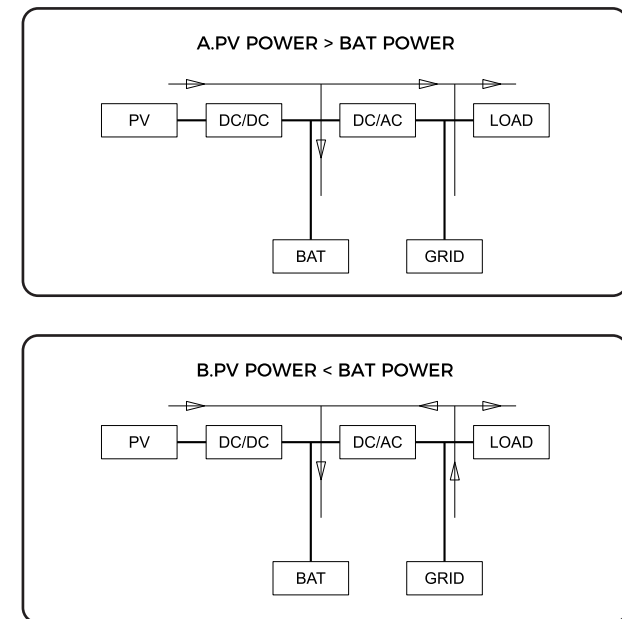

3.5.4 On-grid Economy Mode

Peak: Running Load Priority Mode

Valley: Running Battery Priority Mode

Flat: The grid does not charge the battery and the battery does not discharge to carry the load. When the PV power is greater than the load power, the PV carries the load and the residual power charges the battery; when the PV power is less than the load power, the PV and the grid carry the load together.

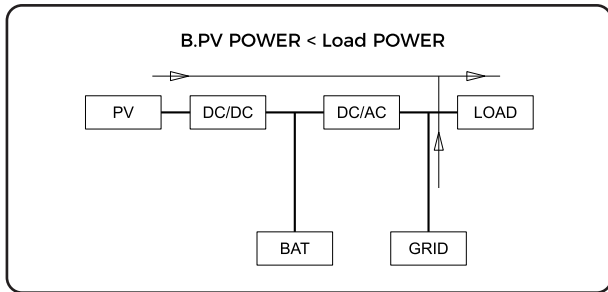
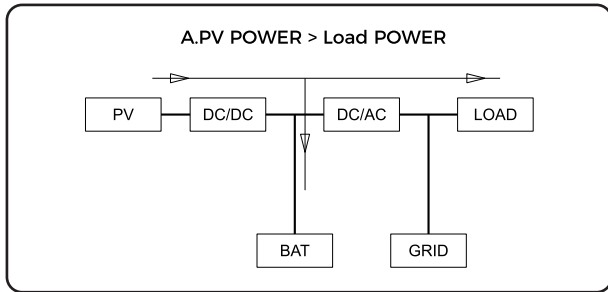

3.5.5 Generator Mode

When the PV power is greater than the battery charging power, the PV power is only used to charge the battery.

When the PV power is less than the battery charging power, priority is given to charging the battery; the generator supplies power to the load and optionally charges the battery.

Tanker on and off is controlled by tanker dry contact, SOC screen for tanker on and off can be set.

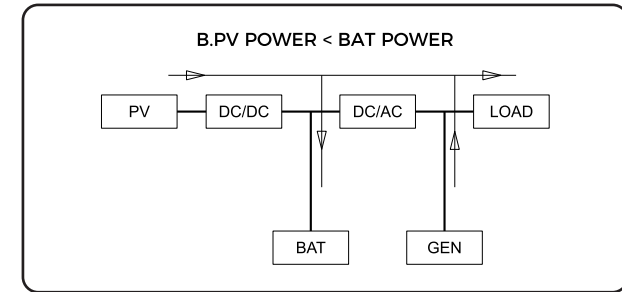
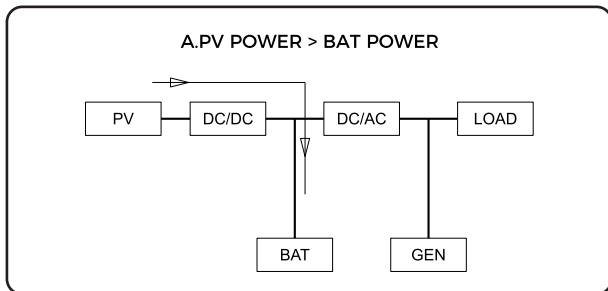

3.5.6 EMS mode

In EMS mode, the HPS is fully controlled by the EMS for charging and discharging, and the machine's built-in standard work logic fails.

Controlled power has PV power, inverter rectifier power (when not connected to the grid, only PV power can be controlled, inverter power is automatically adjusted according to the load). When set to inverter, DC output to AC, when set to rectifier, AC to charge the battery.

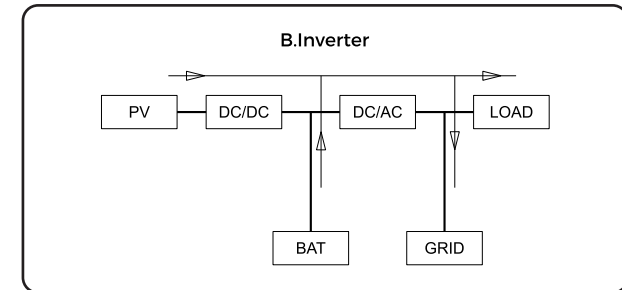
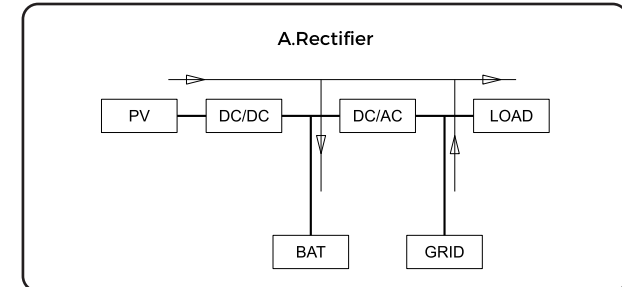

3.5.7 Smart Meter Mode

1) When the PV is greater than the sum of the critical loads, non-critical loads and battery charging power, the PV supplies power to the critical loads and non-critical loads, and the surplus power charges the battery:

a) The anti-reverse current enable is activated and the excess PV power may not be sent to the grid.

b) Anti-reverse current enable is not activated, excess PV power may be fed to the grid (feed power can be set).

2) When PV is greater than critical loads and non-critical loads, but less than the sum of charging power of critical loads, non-critical loads and batteries, PV supplies power to critical loads and non-critical loads, and the remaining power charges the batteries.

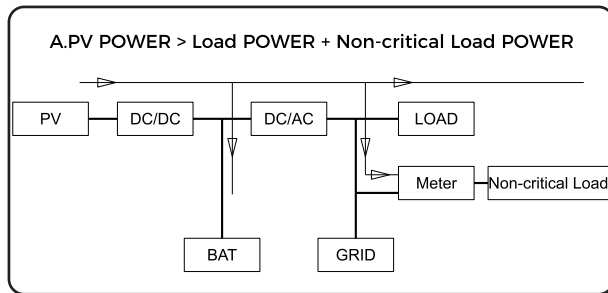

3) When the PV is greater than the critical load, but less than the critical load and non-critical load, the PV gives priority to the critical load, and the surplus power is supplied to the non-critical load:

a) The battery sends power to the meter to enable activation, and the battery and PV together supply power to the non-critical loads;

b) The battery sends power to the meter to enable inactivation, and the PV and the grid jointly supply the non-critical loads.

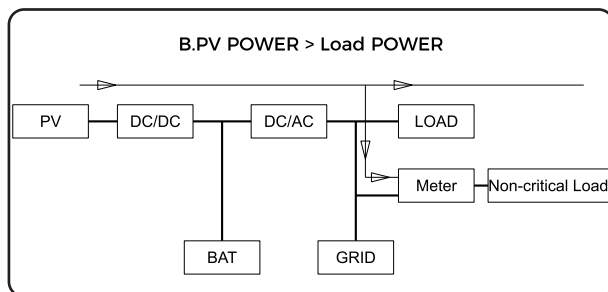

4) The PV is less than the critical load, and the PV and battery together supply power to the critical load:

a) The battery enables activation to the non-critical load, and the battery or the battery and the grid jointly supply power to the non-critical load.

b) Battery enablement to the non-critical load is not activated and the grid supplies power to the non-critical load.

Note: The sum of the inverter power of the PV and the battery must not exceed the rated power of the HPS.

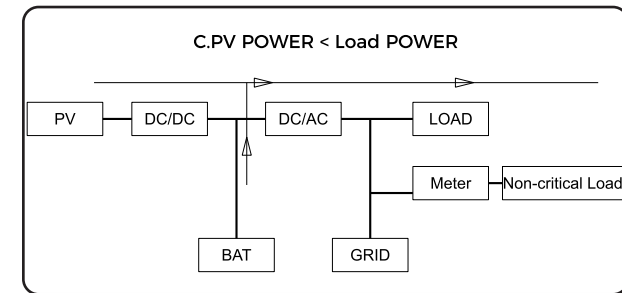

3.5.8 BAT-Smart Meter Mode

1) When the PV power is greater than the sum of the battery charging power and the critical load power, the PV prioritises charging the battery and supplying power to critical and non-critical loads:

- a) The anti-reverse current enable is active and the excess PV power may not be sent to the grid.
- b) Anti-reverse current enable is off, excess PV power can be fed to the grid and the feed power can be set.

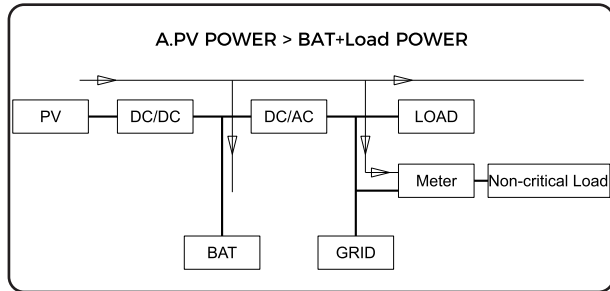

2) When the PV power is greater than the battery charging power, but less than the sum of the battery charging power and the critical load power, the PV gives priority to charging the battery, the excess PV power is fed to the critical load, and the grid feeds the remaining load.

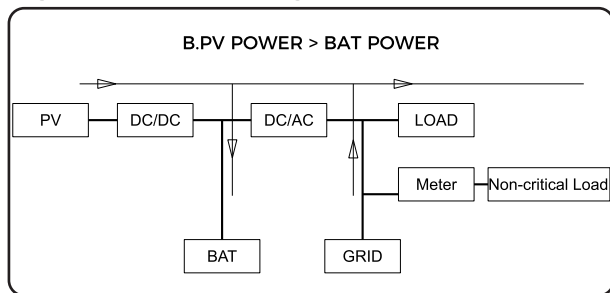

3) When the PV power is less than the battery charging power, the grid gives priority to charging the battery and supplying the loads at the same time.

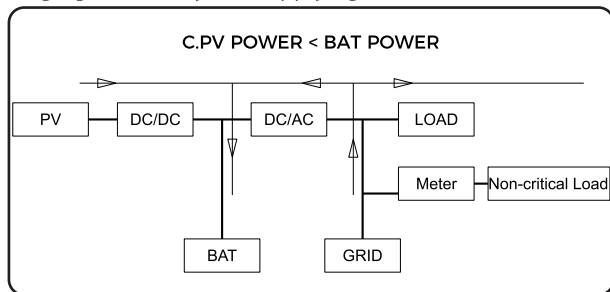

3.5.9 Multi-Stage (Dis)Charge Mode

(1) During non-set time periods, the system runs load priority mode.

(2) During the set time period

- a. If the current voltage (SOC) is higher than the set value, the system operates in load priority mode, in which case the PV and the battery can be fed to the grid, and the feed power can be set.
- b. If the current voltage (SOC) is lower than the set value, the system operates in battery priority mode.

3.5.10 On/Off-grid switch

Operation logic: When grid power on, HPS can switch into on-grid mode automatically, when grid power off, HPS can switch into off-grid mode automatically.

3.5.11 Fault mode

When the HPS energy system fails, the inverter will immediately disconnect the AC/DC contactor and enters into the fault mode, so as to ensure the safety of the system. Inverter continuously monitors fault status and will not enter charge and discharge mode until the fault is eliminated.

3.5.12 Permanent fault mode

When the HPS energy system fails, the inverter will immediately disconnect the AC/DC contactor and enters into the Permanent fault mode, so as to ensure the safety of the system. For example: inverter module failure etc. please contact your local dealer or ATESS directly when inverter enters permanent fault mode, repairmen on site is not allowed without authorization of ATESS.

3.6 Battery setting

Battery is an important part of energy storage system, strict protection is needed in the whole operation process. Protection threshold need to be set on HPS to ensure safe operation of battery, parameters including: battery quantity and unit quantity, capacity, charge current, discharge current, over voltage protection, under-voltage protection and so on. Battery parameter setting need to be done by professional personnel. Improper setting of battery will affect the normal working.

3.7 Storage

If there is a long time before installation or operation, the ATESS HPS15000TL/HPS20000TL/HPS30000TL should be stored appropriately.

- The packaging should be restored to its original state;
- Retain the desiccant in the packaging.
- The ATESS HPS15000TL/HPS20000TL/HPS30000TL can only be stored when it is stopped and all the doors are closed in a dry room to protect the internal circuits against dust and moisture.
- Storage temperature range: -40~60 °C
- Storage relative humidity range: 0%~100 %
- Operating temperature range: -40~60 °C
- Operating relative humidity range:0%~100%
- Max. altitude:5000 m

CAUTION
 Strictly prohibited storage without packing!
 Avoid storage in direct sunlight!
 Keep upright and no stacking on top of the crate.

3.8 Packaging information

No.	Name	Unit	Quantity
1	Inverter main unit	pcs	1
2	Wall-mounting accessory	set	1
3	Expansion bolt	set	4
4	User manual	pcs	1
5	Certificate	pcs	1
6	PV array terminal	set	1

Table 3-8-1 Packaging information

4.1 Installation condition requirements

To ensure normal operation of the machine, the installation environment is required as follows:

- The wall for mounting HPS should be solid and able to bear the weight of HPS in the long term.
- Installation space should be sufficient to cover HPS dimension, HPS dimension and installation gap please see below photo:
- Do not install HPS on flammable or heat vulnerable materials or buildings
- Do not install HPS in a space without good ventilation or dusty, it will cause low cooling fan efficiency, then reduce HPS efficiency, the fan and fan cover should be checked and cleaned every 6 months
- To avoid overheat and power derating, please do not expose HPS under the sun
- Environment temperature around HPS should be -40°C~60°C
- HPS can be installed on vertical or tilted surface as shown in below figure:

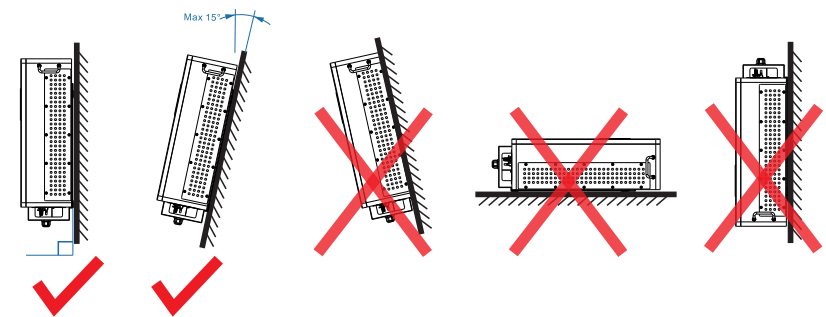

4.2 Installation environment

Although HPS is with IP65 protection level, it is not recommended to install it under direct sun or direct rain/snow to ensure long term performance, below installation environment for reference:

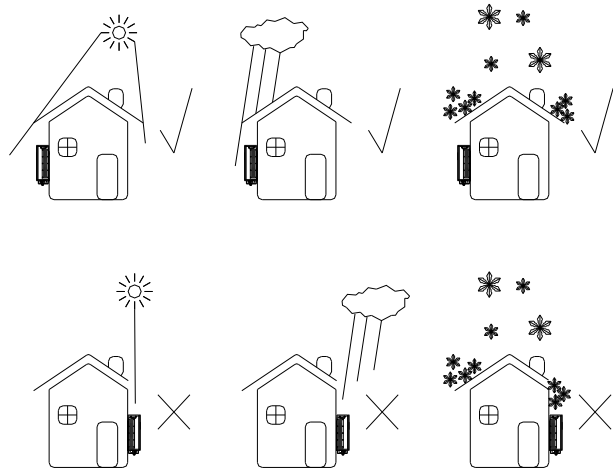

To avoid inverter life span decrease, it is recommended to install shading shield on top of inverter, distance between inverter and top shield please refer to below figure:

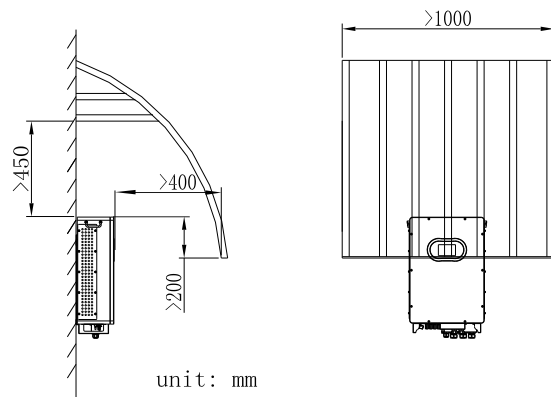

4.3 Space requirement

When installing HPS, reasonable distance should be kept for maintenance and ventilation, please refer to below figure:

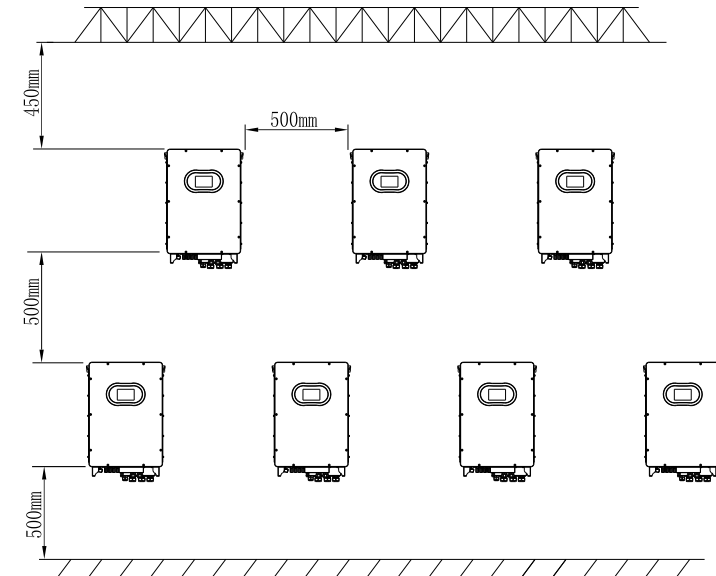

Warning:



When environment temperature is too high, inverter derating is normal operation, but if derating occurs frequently, please check inverter heat dissipation surface or consider to move inverter to area with better ventilation. If fan is dirty please clean, if inverter inner fault please seek for professional service.

4.4 Tools for installation

Tools and spare parts required for installation is as follows:

- Hoisting crane, forklift or fork lift truck (with the capacity for bearing the weight of the inverter)
- Torque wrench
- Screwdriver
- Wire stripper
- Terminal crimping machine
- Heat dryer
- Megger and multimeter

4.5 Mechanical installation

4.5.1 Installation of wall-mounting kit



Before installing the wall-mounting kit, please check and make sure there's no electric cable and gas pipe in the location of installation.

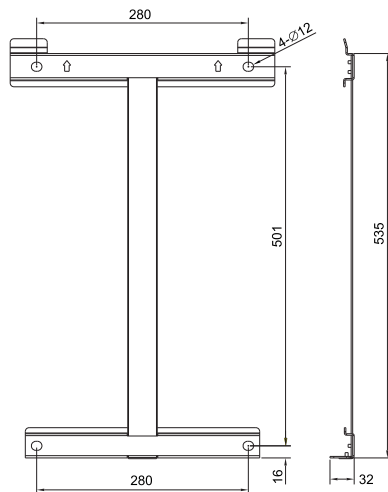

Figure 4-5-1-1 installation gap

Steps:

- A: Please drill the hole according to the hole mask.
B: Please install the expansion bolt as shown.
C: Please install the wall hanger as shown in the picture.

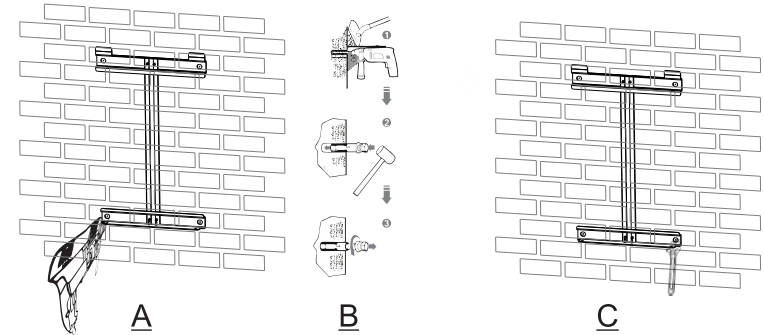

Figure 4-5-1-2 bracket installation



Note: Wall-mounting bracket must be installed first before installing HPS

4.5.2 Installing HPS

Install HPS and stand-alone wiring diagrams, as well as parallel wiring diagrams

A. keep the inverter balance when hanging it to the bracket

B. Tighten the fixing screw to the bracket

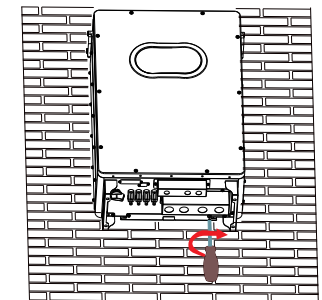
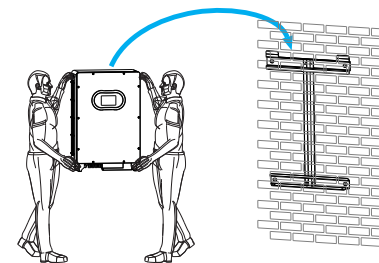
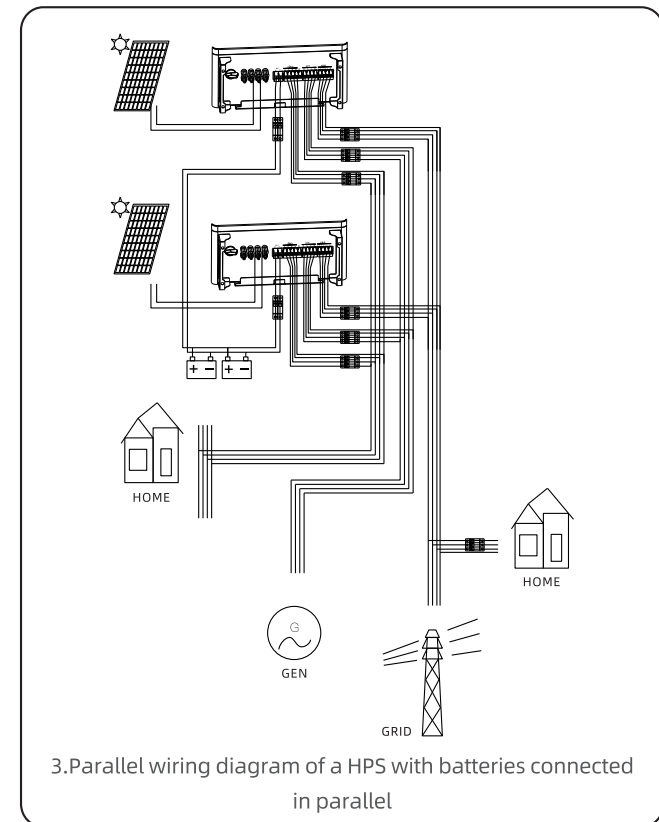
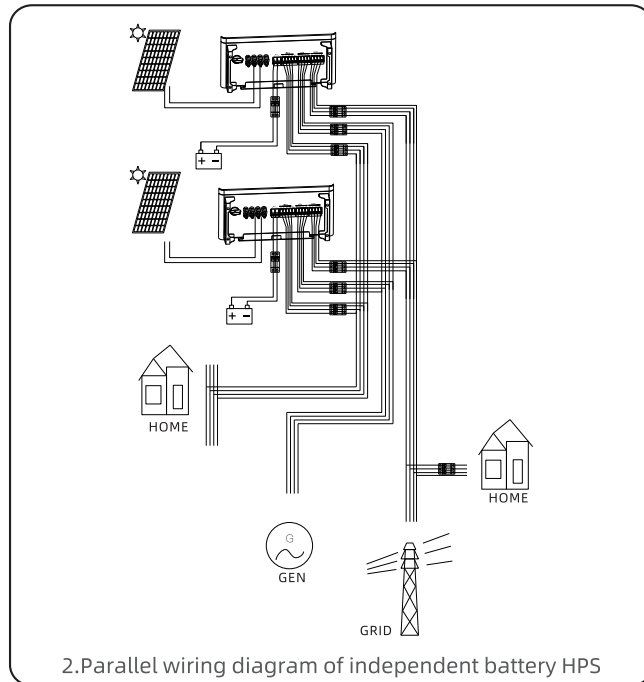
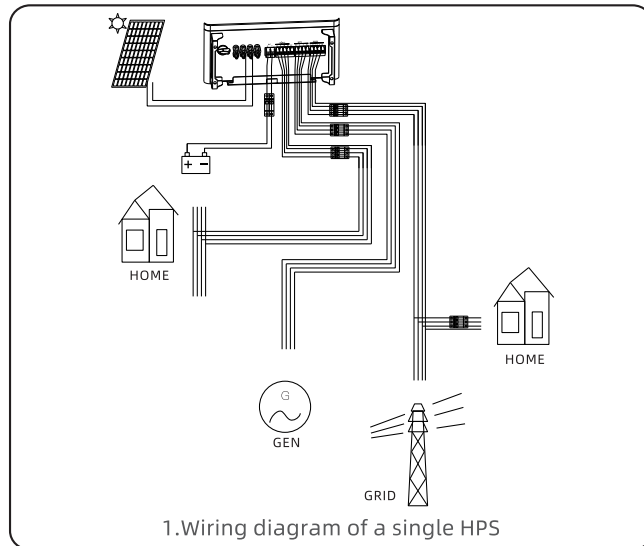

Figure 4-5-2-1 Hanging of inverter

4.6 Electrical installation

4.6.1 Electrical Parallel Wiring Diagrams



Recommended switch for HPS15000TL/HPS20000TL/HPS30000TL

DC breaker: 100A/1000V

AC breaker: 63A/400V

Parallel System Wiring Requirements for Power Lines:

When using HPS15000TL/20000TL/30000TL in a parallel system, please ensure that the power cables for the generator, battery, load grid, and PV are of the same length and cable type. This is to ensure balanced current flow between the units during parallel operation.

4.6.2 Input and output requirements

NOTICE

Caution, risk of danger



There is a danger of electrical shock of high voltage in inverter's operation; only electricians of professional skills can operate.

All connections with this equipment shall be done under non-voltage state.

The inverter may be damaged if input or output terminal is incorrectly plugged.

Failure of acting upon this information may cause serious.

1) Battery

Battery string voltage should not exceed 720V, or else inverter will be in faulty mode

2) Three-phase grid

Inverter will continuously inspect whether the grid satisfy the grid connected conditions. The following is the grid limit for satisfaction of local Grid connected conditions (requirements in different countries may vary, the value can be setup and please refer to local grid connected regulations for details), and the grid is three-phase grid. Meanwhile, it shall be permitted by local power supply department before install Grid-connected inverted power.

Model	HPS15000TL/HPS20000TL/HPS30000TL
Grid Voltage Limit	360V~440V
Grid Frequency Limit	47HZ-51.5HZ/57HZ-61.5HZ

Cable (Cu)	Cable Diameter Requirements (mm ²)	Aperture
Model	HPS15000TL/HPS20000TL/HPS30000TL	
PV +-	Input cable with each at least 4 mm ²	/
BAT +-	Cable with each at least 16 mm ²	M5, 4.8N*m
Grid input A B C	Input cable with each at least 4 mm ²	M4, 2.4N*m
Load output A B C	Input cable with each at least 4 mm ²	M4, 2.4N*m
Communication Wire	0.25mm ² , shielded Twisted pair is recommended	M2, 0.2N*m
Earth Wire	More than 6 mm ² . Green and yellow is recommended	M4, 2.4N*m
N Wire	Cable with each at least 4mm ²	M4, 2.4N*m
Gen	Input cable with each at least 4 mm ²	M4, 2.4N*m

4.6.3 Preparation before cable connection

Before wiring, you need to open the front door of the energy storage controller. The specific steps are as follows:

Step 1: Turn off the AC and DC air. As shown in the figure below, the PV switch is in the "OFF" state.

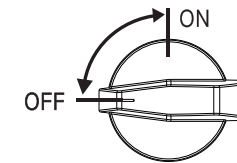

4.6.4 DC side wiring

NOTICE

Caution, risk of danger



1. HPS15000TL/HPS20000TL/HPS30000TL of AC and DC, do not have switches or circuit breakers, customers need to add their own switches, or buy our company design and production switch box.

2. The positive and negative of the battery shall not be connected in reverse. A multimeter shall be used to determine the polarity first, and then connect into the corresponding input ends of the inverter. Specific procedures are as follows:

Step 1: Cut off the distribution circuit breaker at the DC side, and ensure that no voltage on the wire at DC side.

Step 2: Confirm the battery positive and negative voltage within range with a multimeter.

Step 3: Confirm the negative and positive pole with a multimeter.

Step 4 Peel the insulation layer of cable.

Step5: fix cable lug.

1. Place the stripped copper core into the crimping holes of the cable lug.

2. Press the cable lug with the terminal crimping machine. The number of crimps should be more than two.

Step 6: fix heat shrinking tube.

1. choose heat shrink tube according to cable size, and cut about 5cm.

2. fix the tube to cable, cover the lug hole.

3. use air heater to blow the tube and make it shrink.

Step 7: Connect the "Bat+" end of the energy storage controller to the positive terminal of the battery pack with a cable.

1. Pass the cable through the PG waterproof connector.

2. Secure the copper noses at the ends of the wiring to the "Bat+" end of the energy storage controller and the positive terminal of the battery pack.

3. Fasten the bolt with a screwdriver or wrench.

Step 8: Connect the "Bat -" end of the energy storage controller to the negative terminal of the battery pack by cable according to the method of step 7.

Step 9: Connect the "PV+" end of the energy storage controller to the positive pole of the battery board by cable according to the method of step 7.

Step 10: Connect the "PV-" end of the energy storage controller to the negative pole of the battery board by cable according to the method of step 7.

Step 11: Make sure the wiring is secure; tighten the PG waterproof connector.

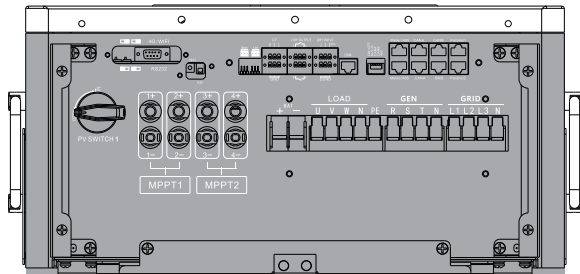

4.6.5 AC side wiring



CAUTION!

Caution, risk of danger

When connecting the AC grid, cut off the circuit breaker at the AC side to ensure that the AC wire connecting to terminals has no electricity.

Connect AC grid:

1) Cut off the circuit breaker at AC side, to ensure that the AC wire connecting to terminals has no electricity. Confirm it with a multimeter.

2)confirm the phase sequence of grid

3)peel the insulation layer of cable

4)fix cable lug

5) fix heat shrink tube

A. choose heat shrink tube according to cable size, and cut about 5cm

B. fix the tube to cable, cover the lug hole

C. use air heater to blow the tube and make it shrink

6)

A. Connect the port L1 marked at "Grid" of HPS with "L1" of the grid.

B. Connect the port L2 marked at "Grid" of HPS with "L2" of the grid.

C. connect the port L3 marked at "Grid" of HPS with "L3" of the grid.

D. connect the port N marked at "Grid" of HPS with "N" of the grid.

7) same with step 6

A. connect LOAD cable U, V, W, N to the U, V, W, N port of HPS.

B. connect GEN cable R, S, T, N to the R, S, T, N port of HPS.

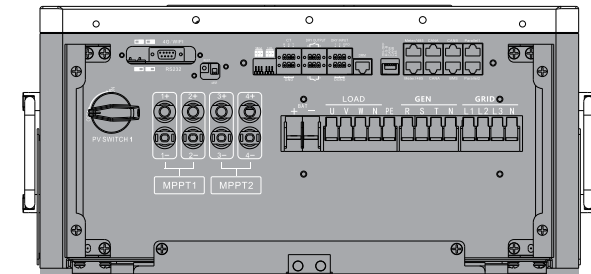
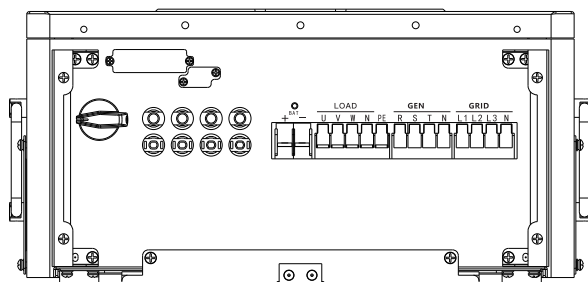

Figure 4-6-1-1 AC output cable connection

4.6.6 Earthing

Inverter must be earthing well for safety; Please make sure of the connection between PE in power distribution cabinet and PE copper in the inverter good; and make sure the earthing cable more than 6mm² and the earthing resistance must below 4 OHM.

Inverter earthing busbar please refer to above photo cable inlet and outlet are on the bottom of inverter, after finishing connection, tighten the cable tighten gland.



4-6-1-2 cable inlet and outlet



Note: The PE busbar is for grounding inside inverter, please do not change to avoid electric shock risk.

4.7 Communication

The HPS series hybrid energy storage system has multiple communication modes. When users need to monitor the operation status of the energy storage and discharge system, RS485 serial port or CAN communication mode can be used for power supply.

4.7.1 RS485

Users can directly use the RS485/RS232 converter for host computer communication. The HPS communicates with the HPS through RS485, and finally communicates with the PC through the RS485 to RS232 datalogger, runs the monitoring software in the PC, and monitors the running status of the single/multiple energy storage controllers in real time.

RS485 communication line uses terminal blocks at both ends, and RS485 communication lines are made by parallel connection of terminals at both ends. The length should not exceed 1000 meters. As shown in Figure 4-7-1-1.

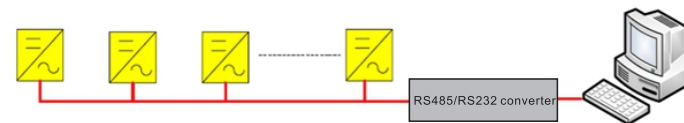

Figure 4-7-1-1 PC monitor through RS485

4.7.2 CAN communication

Rate of CAN communication is between 100K and 500K, and the shielded twisted pair is used for communication to ensure communication quality.

4.7.3 WIFI or 4G communication

WIFI or 4G is an optional configuration, need to buy WIFI communication module or 4G communication module

4.8 Installation inspection

Before the inverter is put into operation, it shall be inspected for installation. Two working men or more shall inspect to ensure correct installation of all installation according to the following table.

Mechanical inspection	
<input type="checkbox"/>	Inverter's bottom is fixed, and the support is stable and reliable.
<input type="checkbox"/>	Enough space is left around inverter.
<input type="checkbox"/>	The ambient temperature, humidity and ventilation satisfy requirements.
<input type="checkbox"/>	Smooth flow of cooling air.
<input type="checkbox"/>	Complete and reliable sealing protection of cabinet.
<input type="checkbox"/>	No deformation and damage to inverter.

Electrical Installation Inspection
<input type="checkbox"/> Complete and firm grounding of inverter.
<input type="checkbox"/> Grid voltage matching the rated input voltage of inverter.
<input type="checkbox"/> Correct phase sequence of grid connection, and tightening torque meeting requirements.
<input type="checkbox"/> Correct connection of DC input anode and cathode, and tightening torque meeting requirements.
<input type="checkbox"/> Correct connection of communication lines, and maintaining a certain distance to other cables.
<input type="checkbox"/> Mechanical Installation Items Inspection
<input type="checkbox"/> Other Inspections
<input type="checkbox"/> All useless conductive parts tied with insulating ribbon.
<input type="checkbox"/> No tools, spare parts, conductive dust generated from drilling or other matters left inside the cabinet.
<input type="checkbox"/> No condensed humidity or icing inside the cabinet.

Table 4-8 Installation Inspection List

The chapter will introduce the procedure of pilot operation, including checking battery voltage, input and output connecting, other preparation working.

5.1 Relevant requirements

Before pilot operation, the installation conditions of the equipment shall be examined thoroughly, in particular whether voltages at DC and AC ends are consistent with inverter's requirements, and whether the polarity etc. are correct. Inspect if the system connection meets requirements in relevant standards or codes and if the system is grounded well.



CAUTION!

Before pilot operation, all switches at AC side and DC side shall ensure to be cut off.

5.2 Inspection

5.2.1 Inverter inspection

Before power on the inverter, please carry out inspections as the following procedures:

Step 1: Inspect inverter's installation and wiring conditions based on the Installation Inspection List in Table 4-8.

Step 2: Ensure the AC&DC circuit breakers are cut off.

5.2.2 Grid voltage inspection

Inspect whether the three phases of the inverter is correctively connected with the three phase sequence of the grid. Inspect whether the line voltage and frequency are within the prescribed range, and record the value. If possible, measure the phase THD (Total Harmonic Distortion), and inspect the curve. If distortion is serious, the inverter may fail to operate.



CAUTION!

When connecting the load, make sure that the three-phase of the load is corresponding to the three-phase of the HPS, otherwise it will cause the motor to reverse.



Warning:

- After manually shutting down, you must press the power button on the LCD, otherwise cannot start automatically.
- Still powered after manual shutdown

5.2.3 DC side voltage inspection

The DC side consists of two parts, from the confluence box or the DC distribution cabinet to the HPS and from the storage battery to the HPS. Ensure that the direct current from the confluence box or DC distribution cabinet is connected to the PV terminal of HPS and is in sequence.

- Make sure the DC input polarity is correct;
- Measure and record each DC (open circuit) voltage. The voltage value of each channel should be almost the same and should not exceed the maximum allowable DC voltage value.
- Battery voltage check, battery parameter setting check

5.3 Power on steps

First power-on

Step 1: Close AC circuit breaker

Step 2: Close DC circuit breaker

Step 3: PV DC switch to ON position

Step 4: Click start on inverter display and wait till 'grid connecting'

Note: when system is powered, 60S later about display will lit

Manual turn-off

During operation, you can click the shutdown button on the LCD, at this time the inverter stops working and stops sending power to the grid.

5.4 Pilot operation completion

The following procedures shall be carried out after the inverter is normally in operation.

Procedure 1: Inspect whether abnormality exists in the inverter, such as excessive noise, excessive heat, abnormal smell or smoke.

Procedure 2: Measure whether inverter voltage, current and THD are stable.

Procedure 3: Operate LCD control panel and inspect whether it displays normally and accurately.

By now, the pilot operation of inverter is fully completed, and we can enter the daily operational maintenance.

5.5 Power off steps



CAUTION!

After the inverter is completely powered off, the general DC switch at battery side and the Grid switch at grid side still maintain voltage. If operations are needed, please be sure to cut off the outer power completely, and wait for not less than 20 minutes

1. Click the OFF button on LCD or turn the off-on knob from ON to OFF.
2. Cut off DC SWITCH.
3. Cut off GRID switch and load switch.



During the power-off process, the energy storage controller sends an alarm as normal. You can continue the power-off step

6 HMI

6.1 Introduction to touch screen

Users can view the operation information of the energy storage controller on the LCD touch screen, as well as set the operating parameters of the energy storage controller.

For ease of operation, the following is a distribution diagram of the LCD menu logic structure.

After the LCD is powered on, enter the boot interface, and about 15S enter the interface home page. At this time, you can start to operate the relevant keys for information review and parameter setting.

The upper right of each page shows the communication status between the LCD and the energy storage controller control board, the station number of the communication end where the energy storage controller is located, the system time, etc.

At the bottom of each page are five common function buttons: "Operating Data", "Historical Data", "System Settings", "Power On/Off", and "Home". With these five common keys, users can operate easily and quickly. On the left side of the interface, the submenu buttons corresponding to the above five commonly used keys are displayed, and the selected buttons are marked in green.

Operating Data	Warnings	System Settings	On/Off	Home
	Current fault	Language Settings		
	History fault	Time setting		
		Device information		
		Equipment maintenance		

6.2 Touch screen operation

6.2.1 Main page

Click the [Main Page] button at the bottom of any other interface to enter this page.

On this page, there are mainly information such as operating status, battery power, grid power and so on. The common function keys under the LCD can be used to switch to other pages.

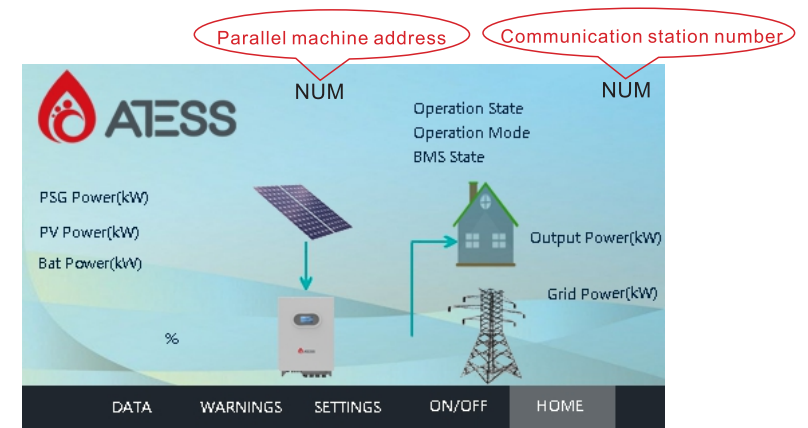

Running status displays content	Notes
Fault	The machine is not turned on or can not be turned on due to fault
Waiting	Boot initialization
Check	System self-test
Permanent	Serious failure occurred
Offline	Offline with load mode
OnGrid	Successfully connected to the grid
PV Charger	PV is only in battery charging mode
Parallel_OffLine	The parallel system waits to enter the off-grid mode
Parallel_OnGrid	The parallel system waits to enter grid-connected mode

Communication station number: The number represents the current station number, which is the 485 communication station number.

Grid-connected mode: When the operating status of the energy storage controller is grid-connected, the current grid-connected mode will be displayed: load priority, battery priority, economic mode, peak shaving and valley filling, EMS mode, generator mode, smart meter, multi-stage charge and discharge mode, etc.

BMS status: When the battery is a lithium battery with BMS, the current BMS status is displayed here. When there is no BMS communication, the "Waiting" status is displayed.

6.2.2 Power On/Off

Click the [ON/OFF] button in any other interface to enter this page. In this page, the main ones are: boot button, shutdown button. Used to select the power on or off operation.

Boot: Click "ON" to boot the system.

Shutdown: Shut down, click "OFF" to shut down.

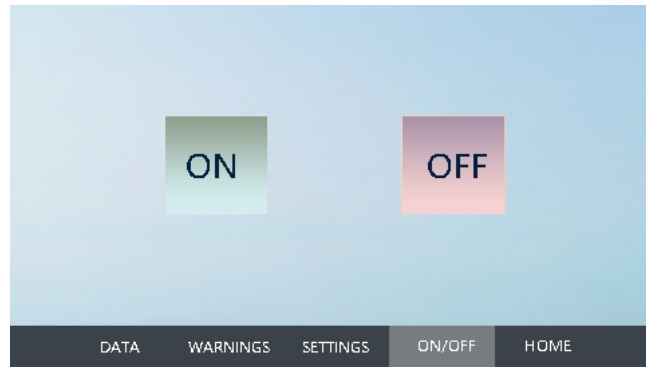

6.2.3 Operating Data

Click the [DATA] button at the bottom of any other interface to enter the submenu of "Run Data". The submenus are: operating data, charge and discharge amount.

Operational data: Displays the current energy storage generation parameters and real-time data including grid voltage, grid frequency, grid current, battery voltage, battery current, temperature in the chassis, and total power generation time (real-time update).

BUS voltage	V	Bat daily discharge	kWh
BUS voltage+	V	Bat daily discharge time	min
BUS voltage-	V	Bat total discharge	kWh
Battery voltage	V	Bat total discharge time	h
Bat cell voltage	V	Bat daily charge	kWh
Bat inductor current	A	Bat daily charge time	min
DC side temperature	°C	Bat total charge	kWh
BUCK inductor	°C	Bat total charge time	h
Battery power	kW	Start detection time	s

The screenshot shows a light blue background with a table of operational data. At the bottom, there is a dark navigation bar with buttons for 'DATA', 'WARNINGS', 'SETTINGS', 'ON/OFF', and 'HOME'. The 'DATA' button is currently selected and highlighted.

6.2.4 System settings

Language settings: Select the interface language under this page, currently only two languages, Chinese and English.

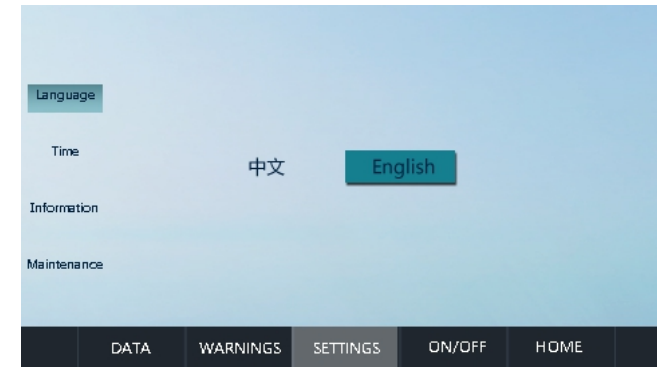

Time: Set the system time under this page (you can modify it here when the time and date displayed by the LCD do not correspond to the actual local time date).

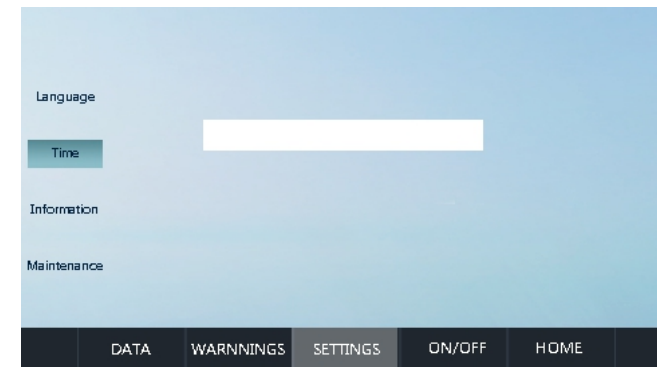

Information: The manufacturer, serial number, software and hardware version information, and factory date information are displayed under this page, which only shows that it cannot be modified.



Maintenance: The interface requires a password to log in, the password is provided by technical support, only electricians or maintenance personnel who are fully familiar with the composition and working principle of the entire equipment system can operate this item, so as not to cause damage to personal safety and energy storage controller performance, please operate with caution.

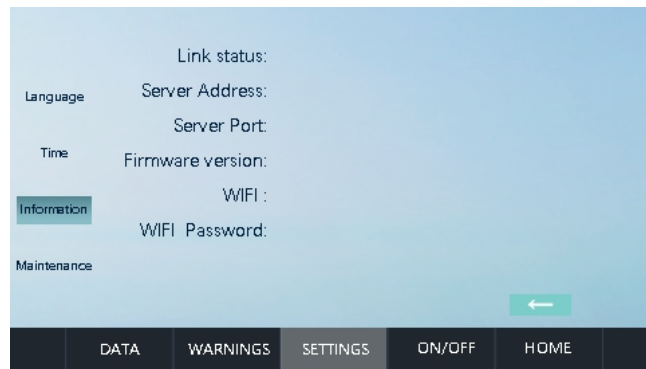

Link status: Displays the network connection status of the machine. 0: mobile network, 1: WIFI, 2: no network.

Server Address: Server address, default set to: enercllo-atesspower.com.

Server port: The server port number, default set to: 5279.

Firmware version: Communication board ARM program version.

WIFI: WIFI name, case sensitive.

WIFI Password: WIFI password.

Protection parameters

Protection	Output Voltage(V)	400	0
	Output Frequency(Hz)	50	0
Control	Max.DC Voltage(V)	700.0	0.0
	Max.Bypass Voltage(V)	440.0	0.0
Calibration settings	Min.Bypass Voltage(V)	360.0	360.0
	Max.Bypass Frequency(Hz)	52.00	52.00
Grid Management	Min.Bypass Frequency(Hz)	48.00	0.00
	Output Current Limit(A)	30.0	30.0
Factory Settings	Detection Time(s)	10	0
	Output Power Limit(%)	105	0
	Start Voltage(V)	200.0	0.0

Output Voltage: Set the off-grid output voltage, you can set 380 or 400, which can be changed according to actual needs, and you need to power off and restart after the change to take effect.

Output Frequency: Set the AC output frequency, you can set 50 or 60, you can change it according to actual needs, and you need to power off and restart after the change to take effect.

Max.DC Voltage: PV voltage upper limit protection value, when the PV voltage is greater than the set value, the machine PV overvoltage fault.

Max.Bypass Voltage: The upper limit of the grid voltage, beyond which it will be cut into off-grid mode, which is set by 110% of the rated value.

Min.Bypass Voltage: The lower limit of the grid voltage, below which it will cut into off-grid mode, and the default setting is 90%.

Max.Bypass Frequency: The upper limit of the grid frequency, beyond which it will switch to off-grid mode, the default setting is rated +2.

Min.Bypass Frequency: Lower grid frequency, below which it switches into off-grid mode, with the default setting of -2.

Output Current Limit: The upper limit of the output current, above the upper limit, the energy storage controller will shut down, The default is 1.2 times the rated grid current.

Detection Time: Boot detection time, default preset 60 seconds, minimum 10 seconds, maximum 300 seconds.

Output Power Limit: Percentage of AC output power in constant power discharge mode. It can be set to 1%-120%, the default setting is 100%, and it is recommended not to exceed 110%.

Start Voltage: Grid-connected power on voltage. The default is 300V.

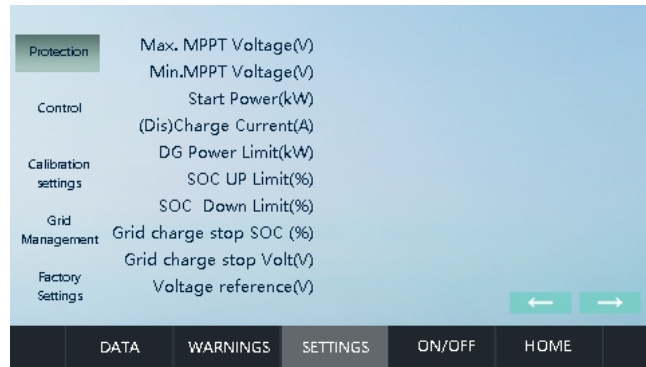

Max.MPPT Voltage: PV voltage limit

Min.MPPT Voltage: The lower limit of PV voltage

Start Power: Photovoltaic on-power, when the PV power is less than the set power on power, the MPPT will reset.

(Dis)Charge current: The size of the battery charge and discharge current.

DG Power Limit: Only the "Generator Mode" mode is in effect, which is the upper limit of the engine power. The default maximum setting is 1.2 times the rated power.

SOC UP Limit, SOC Down Limit: Only when the battery has BMS, the current battery SOC is lower than the lower limit, low voltage alarm will be reported, when it is higher than the upper SOC limit, low voltage alarm will be eliminated.

Grid charge stop SOC(%), Grid charge stop Volt(V): When the current SOC or any cell voltage reaches the preset Grid Charge Stop SOC or Grid Charge Stop Voltage, the grid will stop charging.

Voltage reference: The bus voltage sets the reference value, the default is 730V.

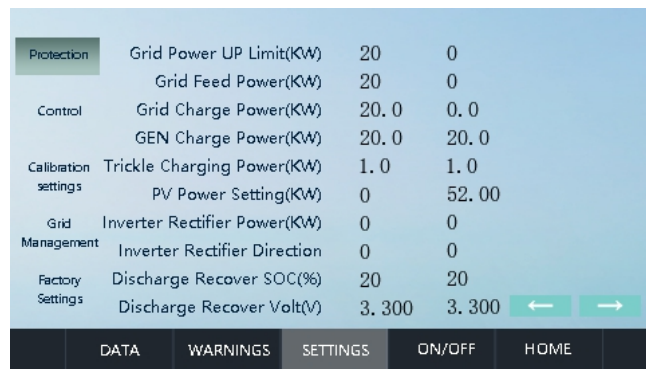

Grid Power UP Limit: The maximum power drawn from the grid.

Grid Feed Power: The maximum power fed to the grid.

Grid Charge Power: The power grid charges the battery.

GEN Charge Power: The maximum power of the generator rechargeable battery. Max. 20 kw.

Trickle Charging Power: When the battery discharges to the end of the discharge or triggers the low voltage alarm, the battery stops discharging, and the power grid loads and charges the battery according to the set power.

PV Power Setting: It only works in EMS mode and is used to set the PV maximum power.

Inverter Rectifier Power: Only active in EMS mode, set the power of machine rectification or inverter.

Inverter Rectifier Direction: Only valid in EMS mode, set "0" direction to rectification, set "1" direction to inverter.

Discharge Recover SOC / Discharge Recover Volt: It is only used for "peak period" of "load priority" and economic mode in grid-connected state. And when that discharge of the battery is stop, judging what the discharge of the battery is resumed.

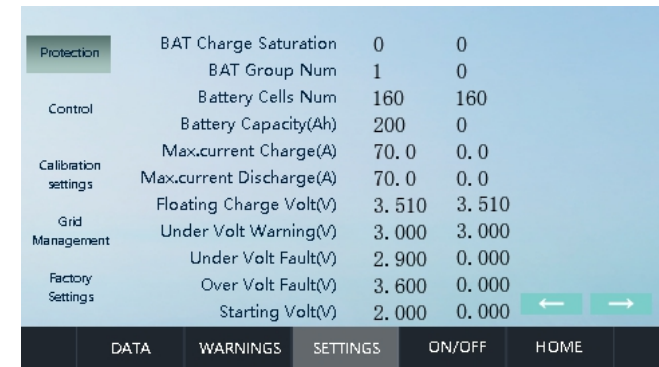

This page is the battery parameter setting page, the battery is an important part of the energy storage control system, and the battery parameters need to be carefully confirmed whether they are consistent with the actual situation.

BAT Charge Saturation: Reserved.

BAT Group Num: The number of battery modules connected in parallel. For example, 2V/200Ah, 240 in series and 2 in parallel, the number of groups is set to 2.

Battery Cells Num: The number of cells in each string of the battery pack. For example, 2V/200Ah, 240 in series and 2 in parallel, the number of units is set to 240.

Battery Capacity: Capacity of single battery, in Ah. For example, 2 V/200Ah, 240 series and 2 parallel, the capacity is set to 200Ah.

Max.current Charge / Max.current Discharge: Battery current protection value. Used to determine whether the battery is overcurrent.

Floating Charge Volt: Battery float voltage. When the cell voltage reaches this setting, the charging current approaches 0 A.

Under Volt Warning: The value of the cell voltage when the battery is undervoltage. When the battery is low voltage, it will enter the single PV mode in the off-grid state, which can only charge the battery, and trickle charge the battery in the grid-connected state.

Under Volt Fault: The value of the cell voltage during battery undervoltage protection. When the battery voltage is less than or equal to the set value, the energy storage controller will stop.

Over Volt Fault: Voltage of the overvoltage protection unit of the battery. When the battery voltage reaches the set value, the energy storage controller will stop.

Starting Volt: When the voltage of the battery unit of the energy storage controller is greater than the set value, the energy storage controller can start to operate, otherwise, the "No_Bat_Fault" will be reported.

Protection	Discharge Stop SOC(%)	5	0
	Discharge Stop Volt(V)	2.900	2.900
Control	Charge Stop SOC(%)	100	00
	Charge Stop Volt(V)	3.510	3.510
Calibration settings	GEN Start SOC(%)	10	0
	GEN Stop SOC(%)	90	90
	GEN Start Volt(V)	2.900	2.900
Grid Management	GEN Stop Volt(V)	3.510	3.510
	BAT Compensate Grid SOC(%)	30	30
Factory Settings	BAT Compensate Grid Volt(V)	3.300	3.300
	Float Charge Volt Limit(V)	0.10	0.00

Discharge Stop SOC, Discharge Stop Volt: Only used for "load first" and "peak period" in economic mode, the battery will stop discharging when the battery voltage or SOC reaches the discharge cutoff voltage or SOC.

Charge Stop SOC, Charge Stop Volt: Only used for "battery first" and "valley" periods of economic mode, the battery will stop charging when the battery voltage or SOC reaches the charging cutoff voltage or SOC.

GEN Start SOC, GEN Start Volt: When the generator is enabled, when the battery voltage or SOC reaches the set generator starting voltage or SOC, the inverter controls the dry contact to start the oil engine.

GEN Stop SOC, GEN Stop Volt: When the generator is enabled, when the battery voltage or SOC reaches the set generator stop voltage or SOC, the inverter controls the dry contact to turn off the generator.

BAT Compensate Grid SOC, BAT Compensate Grid Volt: Used only for Load Priority and Peak Period in Economy Mode. When the battery voltage or SOC is greater than the set value, the priority is to load the battery. On the contrary, priority is given to the grid with load.

Float Charge Volt Limit: When the cell voltage > (FloatingCharge Volt-Float Charge Volt Limit), the battery begins to enter the float state. The charging current decreases gradually, and the charging current is 0 A when the floating charge voltage is reached.

Protection	Parallel Addr
	Number Of Parallel Machines
Control	Parallel Redundant Number
	ATS Numbers
Calibration settings	ATS Communication Station
	AC Over Temp Protection(°C)
Grid Management	DC Over Temp Protection(°C)
	Soft Start Diff of Voltage(V)
Factory Settings	PSG Nominal Power(KW)
	CANb Baud Rate(Kbps)
	RS485 Baud Rate(bps)

Parallel Addr: The device address of the parallel system, set '1' as the host, other as the slave.

Number of Parallel Machines: The total number of devices in the parallel system is set to 2 for 2 devices in parallel, 3 for 3 devices, and so on.

Parallel Redundant Number: Maximum fault quantity of parallel system: when it is set as 0, all devices will be transferred to fault when any device of parallel system fails; when it is set as 1, other devices will still operate normally when the fault quantity is not more than 1.

ATS Number: The number of ATS connected. Default value: 1.

ATS Communication station: ATS communication station number. Default value: 1.

AC Over Temp Protection: AC temperature protection, over the temperature value shutdown. The default is 85°C.

DC Over Temp Protection: DC temperature protection, over the temperature value shutdown. The default is 85°C.

Soft Start Diff of Voltage(V): During the DC side soft start, the main contactor can be closed only when the bus voltage and the battery voltage reach the difference value. The default value is 50V.

PSG Nominal Power(kW): When the grid-tied inverter is connected and the grid-tied inverter function is enabled, this parameter is used to set the rated power of the grid-tied inverter used.

CANb Baud Rate(Kbps): Set the baud rate of CANb communication, the default value is 20.

RS485 Baud Rate(bps): Set the baud rate of RS485 communication, the default value is 9600.

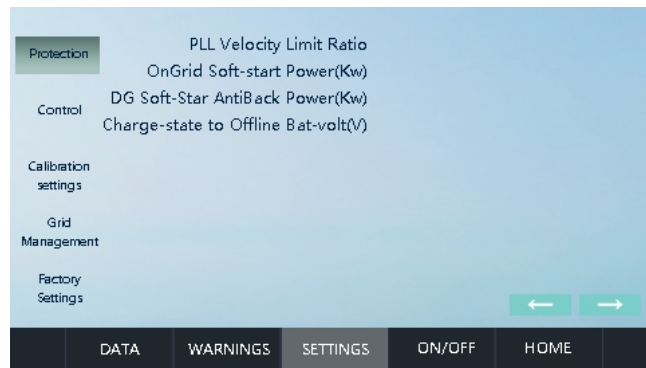

PLL Velocity Limit Ratio: Used to adjust the grid-tied phase-locked control of step length, the default value is 10.

OnGrid Soft-start Power(kW): When OnGrid soft-start is enabled, if the current off-grid load power is greater than this value, the system will perform a loaded soft start when switching to grid-connected mode; otherwise, it will not perform a soft-start.

DG Soft-Star AntiBack Power(kW): When switching to generator mode and the conditions for OnGrid soft-start are met, in order to prevent backfeeding to the generator during the soft-start process, the loaded soft start will begin from this power level.

Charge-state to Offline Bat-volt(V): In single-PV mode, when the battery cell voltage rises above this value during charging, the system will switch to off-grid mode.

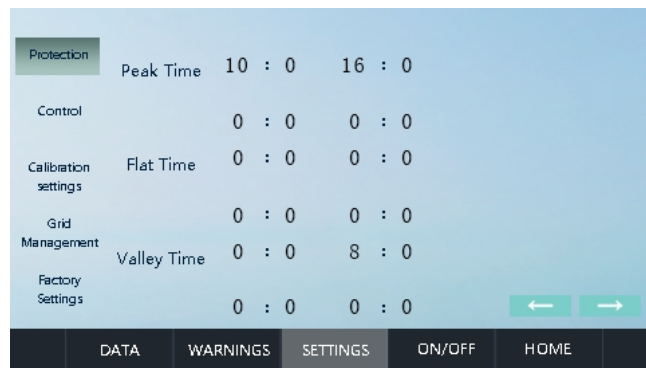

Peak Time, Flat Time, Valley Time: Only in effect in the "Economic Mode" and is used to set the time period range of peak, flat, and valley periods. The peak period is the time of the highest electricity price per day. The valley period is the time period of the lowest electricity price per day.

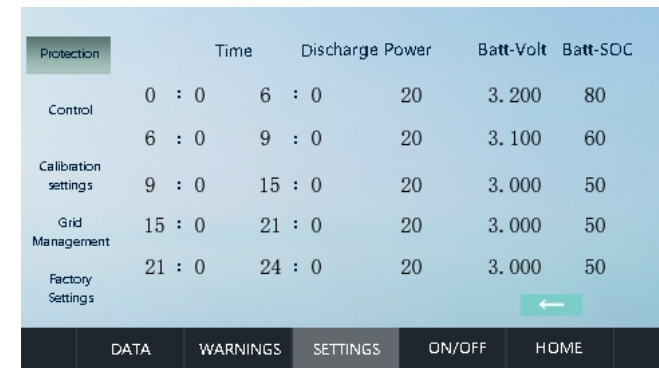

"Multi-stage charge and discharge" mode parameter setting interface:

Time: Used to set the usage period.

Discharge power: The maximum discharge power limit of the battery.

Batt Volt, Batt SOC: When the battery cell voltage or battery SOC is greater than the set value, the machine runs the load priority logic, and the priority battery discharge with load; When less than the set value, the machine runs battery priority logic and priority grid discharge with load.

Control instructions

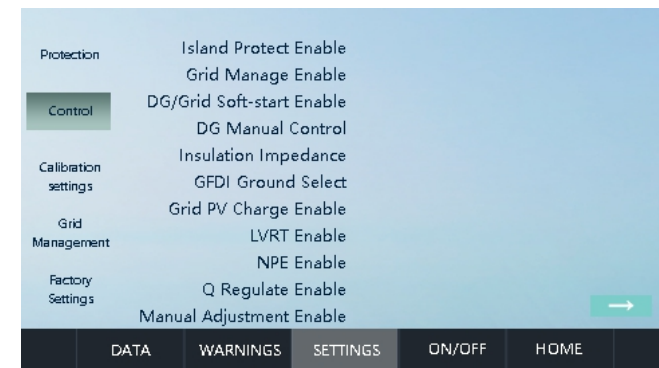

Island Protect Enable: A protection function that prevents the energy storage controller from correctly cutting into the off-grid mode under abnormal grid conditions.

Grid Manage Enable: Reserved.

DG/Grid Soft-start Enable: When set to 1, only the loaded soft-start for switching to generator mode is enabled. When set to 2, the loaded soft-start for switching to either generator mode or grid mode is enabled. The default value is 0.

DG Manual Control: When the generator function is enabled, this parameter can be used to manually control the generator's dry-contact start/stop signal. Setting it to 1 will start the generator, and setting it to 0 will stop the generator. After the parameter is set once and the generator responds, the parameter becomes invalid. The default value is 0.

Insulation Impedance: Reserved.

GFDI Ground Select: Reserved.

Grid PV Charge Enable: When set to 1, the grid and PV can charge the battery at the same time; in generator mode, the generator and PV can charge the battery at the same time. When set to 0, if PV is connected, the grid will not charge the battery; if there is no PV, the grid can charge the battery.

LVRT Enable: Reserved.

NPE Enable: When this parameter is set to 1, the NPE function is enabled; when it is set to 0, the NPE function is not enable.

Q Regulation Enable: Reserved.

Manual Adjustment Enable: Reserved.

Protection	Forced Charge Enable	0	0
	Meter Switch Enable	0	0
Control	GEN Charge Enable	10	0
	Bat to Non-Critical Enable	0	0
	Select Volt or SOC	0	0
Calibration settings	EMS Enable	0	0
	Meter Station NumbParallel	10	10
Grid Management	CT Ratio	200	200
	System ID Sign	0	0
Factory Settings	GEN Enable	0	0
	BMS Communication Enable	0	0

Forced Charge Enable: Set to 1 when using batteries produced by ATESS, otherwise set to 0.

Meter Switch Enable: Set to 0 when the meter is connected and the collector produced by ATESS is connected; Connect only the meter to 1.

GEN Charge Enable: When set to 1, the generator can charge the battery; When set to 0, the oil generator cannot charge the battery.

Bat to non-critical Enable: Only when the "smart meter" mode is connected to the meter and is active, and it is set to 1, the battery can supply power to the grid-side load; When set to 0, the battery cannot supply power to the grid-side load.

Select Volt or SOC: When set to 0, use battery voltage control; When set to 1, battery SOC control is used.

EMS Enable: Enter "EMS mode" when set to 1, exit "EMS mode" when set to 0.

Meter Station Number Parallel: Set the 485 communication address of the meter.

CT Ratio: The ratio of meter CT.

System ID Sign: Used for the server to identify the energy storage system, the same set of parallel system set the same number, otherwise set a different number, the stand-alone system is set to 0.

GEN Enable: When the grid input end of the energy storage controller is connected to the generator, the generator enable needs to be set to 1, otherwise it is set to 0. When the generator is connected with ATS, it can not be enabled to be 1.

BMS Communication Enable: Set to 1 when the machine is in BMS communication with the battery; otherwise, set to 0.

Protection	ATS Enable
	ATS Station Number Enable
Control	Anti-reflux Enable
	Fully-Anti-reflux Enable
Calibration settings	Factory Reset Enable
	Boot/APP Burn Selection
	Parallel Enable
Grid Management	Parallel Addr Switch Enable
	Shared Battery Enabled
Factory Settings	PSG Enable
	System Num

ATS Enable: When the energy storage controller is used with the ATS produced by ATESS, the ATS enable needs to be modified to 1. ATS from other manufacturers is set to 2. The default is 0.

ATS Station Number Enable: Reserved.

Anti-reflux Enable: When set to 1, the machine does not feed the grid; when set to 0, the machine can feed the grid.

Factory Reset Enable: When setting 1, clear the power information recorded on the data page. The parameter settings are not modified.

Boot/APP Burn Selection: Reserved.

Parallel Enable: When set to 1, the parallel function is enabled, and all devices participating in the parallel function are set to 1.

Shared Battery Enable: When used in parallel. If connected to the same battery set 1, otherwise set 0. Default is: 0.

PSG Enable: When set to 1, the function for enabling the grid-tied inverter access is activated. The default value is 0.

System Num: Reserved.

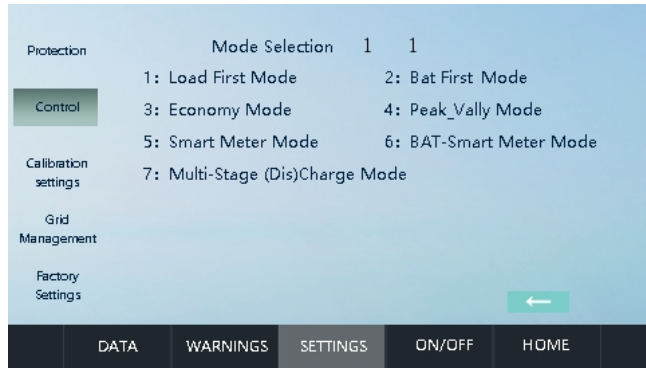

Mode Selection: Set the mode of inverter operation. 1: Load First Mode, 2: Bat First Mode, 3: Economy Mode, 4: Peak_Vally Mode, 5: Smart Meter Mode, 6: BAT-Smart Meter Mode, 7: Multi-Stage (Dis)Charge Mode

Calibration settings

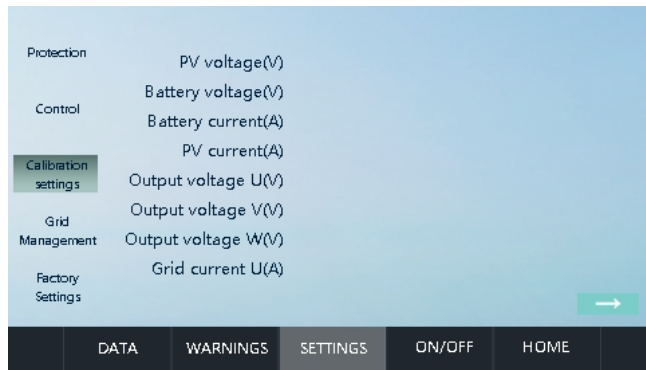

The parameters on this page are important parameters and factory preset parameters, please do not modify them without the consent of relevant personnel. The Company is not responsible for any consequences.

Grid management

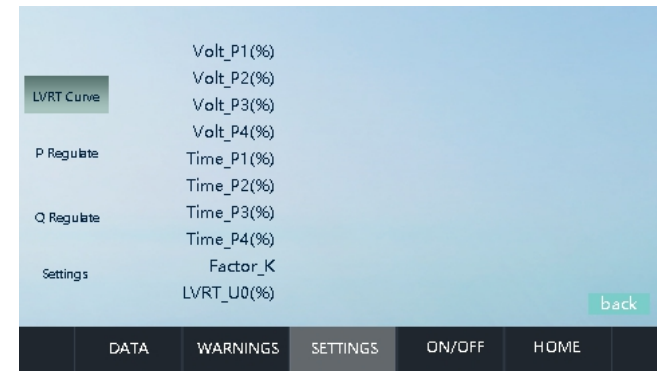

The parameters on this page are important parameters and factory preset parameters, please do not modify them without the consent of relevant personnel. The Company is not responsible for any consequences.

Factory Settings

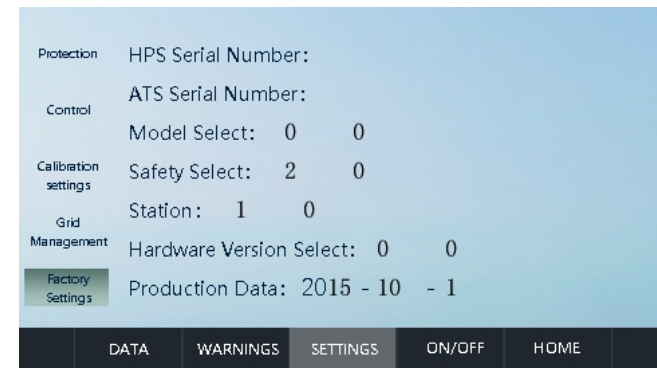

The parameters on this page are important parameters and factory preset parameters, please do not modify them without the consent of relevant personnel. The Company is not responsible for any consequences.

6.2.5 Alarm information

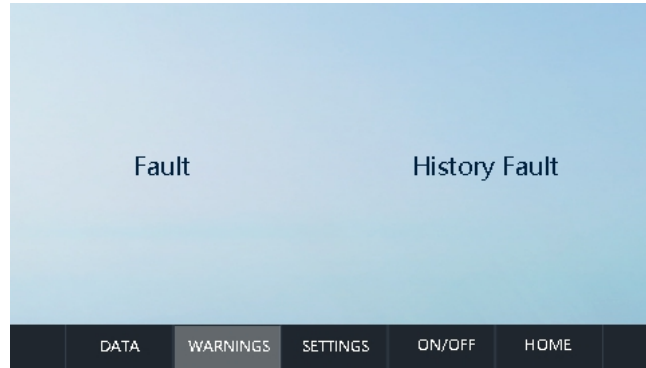

The parameters on this page are displayed for alarm information, which are divided into current faults and historical faults.

Time		Context
-	: :	
-	: :	
-	: :	
-	: :	
-	: :	
-	: :	
-	: :	
-	: :	

Alarm information: The fault reported by the energy storage inverter is displayed, the fault time is displayed on the left, and the corresponding fault name is displayed on the right.

6.3 LCD display information schedule

6.3.1 General history failure table

No.	Description
1	PV_Reseverd_Failure
2	IGBT_Failure
3	EEPROM_Write_Failure
4	EEPROM_Read_Failure
5	AC_MainContactor_Failure
6	AC_SlaveContactor_Failure
7	GFDI_Failure
8	GFCI_Failure
9	RISO_Failure
10	BAT_MainContactor_Failure
11	AC_BypassOverPower_Failure
12	AC_U_BypassOverPower_Failure
13	AC_V_BypassOverPower_Failure
14	AC_W_BypassOverPower_Failure
15	BAT_Reseverd_Failure
16	Reseverd_Failure
17	PV2_OverVolt_Fault
18	INT_L2_OverCurr_Fault
19	INT_L3_OverCurr_Fault
20	BMS_Communicate_Fault

No.	Description
21	INT_PV2_OverCurr_Fault
22	BMS_Fault
23	BAT_OCP_Fault
24	INT_BUS_unbalance_Fault
25	PV1_OverVolt_Fault
26	INT_BAT_OverVolt_Fault
27	INT_PV1_OverCurr_Fault
28	INT_BAT_OverCurr_Fault
29	INT_INV_OverVolt_Fault
30	INT_INV_OverCurr_Fault
31	INT_BL_OverCurr_Fault
32	INT_BUS_OverVolt_Fault
33	AC_NoUtility_Fault
34	AC_GridPhaseSeque_Fault
35	AC_PLL_Fault
36	AC_Volt_Unbalance_Fault
37	AC_Curr_Unbalance_Fault
38	INV_A_OCP_Fault
39	INV_B_OCP_Fault
40	INV_C_OCP_Fault
41	AC_WU_OverVolt_Fault

No.	Description
42	AC_WU_UnderVolt_Fault
43	AC_VW_OverVolt_Fault
44	AC_VW_UnderVolt_Fault
45	AC_UV_OverVolt_Fault
46	AC_UV_UnderVolt_Fault
47	AC_OverFreq_Fault
48	AC_UnderFreq_Fault
49	AC_GridCurr_DcHigh_Fault
50	PV1_CurrHigh_Fault
51	PV2_CurrHigh_Fault
52	AC_GridCurr_High_Fault
53	AC_L1Curr_High_Fault
54	AC_L1CurrDc_High_Fault
55	AC_Overload_Fault
56	AC_Lightload_Fault
57	BAT_OverTemp_Fault
58	Smake_alarm_Fault
59	AC_OverTemp_Fault
60	DC_OverTemp_Fault
61	AC_BypassOverPower_Fault
62	AC_U_BypassOverPower_Fault

No.	Description
63	AC_V_BypassOverPower_Fault
64	AC_W_BypassOverPower_Fault
65	AC_L2Curr_High_Fault
66	AC_L3Curr_High_Fault
67	LcdEmergencyStop
68	NO_Bat_Fault
69	BAT_MainContactor_Fault
70	AC_U_Overload_Fault
71	AC_V_Overload_Fault
72	AC_W_Overload_Fault
73	GFDI_Ground_Fault
74	AC_Contactor_Fault
75	GFDI_AirSwitch_Fault
76	PV_Thunder_Warming
77	AC_Thunder_Warming
78	BAT_Thunder_Warming
79	BusVolt_Unbalance_Fault
80	INT_PV3_OverCurr_Fault
81	ATS_Parallel_Coum_Warning
82	ATS_Contactor_rejection

Table 6.3.1 General history failure table

6.3.2 Severe history failure table

No.	Description
1	PV_Reseverd_Failure
2	IGBT_Failure
3	EEPROM_Write_Failure
4	EEPROM_Read_Failure
5	AC_MainContactor_Failure
6	AC_SlaveContactor_Failure
7	GFDI_Failure
8	GFCI_Failure
9	RISO_Failure
10	BAT_MainContactor_Failure
11	AC_BypassOverPower_Failure
12	AC_U_BypassOverPower_Failure
13	AC_V_BypassOverPower_Failure
14	AC_W_BypassOverPower_Failure
15	BAT_Reseverd_Failure
16	Reseverd_Failure

Table 6.3.2 Severe history failure table

6.3.3 Inverter status

No.	Description
0	wait
1	check
2	Grid mode
3	malfunction
4	Permanent failure
5	Off-grid mode

7 Routine Maintenance

7.1 Fan Maintenance

To ensure that the inverter works normally, you need to clean the air filter regularly. When the inverter is working in a high temperature environment, good ventilation and heat dissipation can effectively reduce the probability of load shedding. The inverter is equipped with a cooling fan. When the internal temperature of the inverter is high, the fan works to reduce the internal temperature. If the inverter is low in output due to excessive temperature, the following are possible causes and countermeasures.

- The fan is clogged and the fan and fan cover need to be cleaned.
- The fan is damaged and the fan needs to be replaced.
- Inverter installation location is poorly ventilated, and the appropriate installation location should be selected according to basic installation requirements



Warning:

Do not use a gas pump to clean the fan, as this may cause damage to the fan.

Fan cleaning or replacement:

1. Before cleaning or replacing the fan, please make sure that the DC side and AC side of the inverter have been disconnected.

- Turn off the DC side switch.
- Unplug the DC input terminal (user needs to use a tool to disconnect the DC connection).
- Disconnect the AC open.

2. Rotate the screw counter clock wise with an M5 Phillips screwdriver.

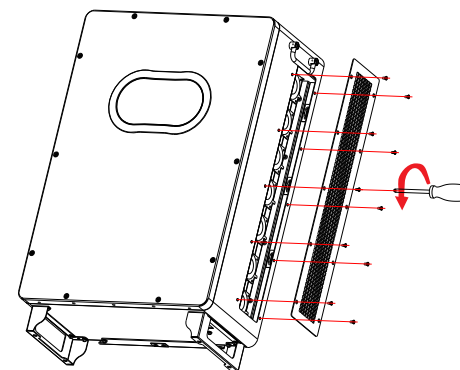

3. Disconnect the fan connector and remove the fan as shown below

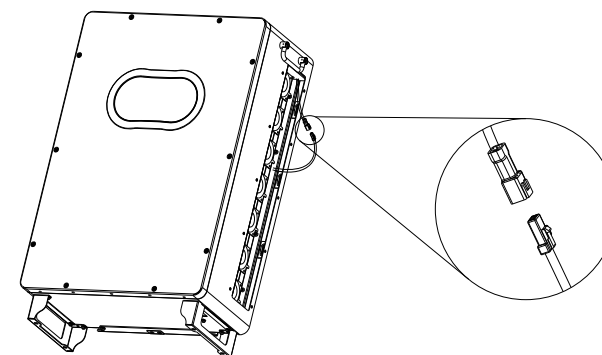

4. Clean the fan and steel mesh or replace the fan

Cleaning fan and steel mesh

- Clean the fan and steel mesh with a gas pump or other tools.
- Remove each fan separately for cleaning if necessary. Replace the fan
- Use a Phillips screwdriver to remove the fan that needs to be replaced.
- Replace the brand new fan, arrange the wire harness and fix it with a cable tie.

5. Reinstall the fan mounting plate and inverter.

7.2 Regular maintenance

Maintenance item	Period
Read data from the datalogger	Monthly
Check if the cable connection is loose	Monthly
Manual inspection of AC and DC circuit breakers	Monthly
LCD stop function	Monthly
Check if there is abnormal noise during the running of the machine	Weekly
Check battery components for abnormalities, swelling, smoke	Daily



The energy storage controller must be regularly maintained to ensure its normal operation and service life.

The recommended routine maintenance cycle and work contents are shown in Table 7-2.

7.3 Waste treatment

The energy storage controller will not pollute the environment, and the constituent materials and components of the product will meet the environmental protection requirements. ATESS shall, according to environmental protection requirements, be treated according to local regulations when the energy storage controller is used.

8.1 Specification

Model	ATESS HPS15000TL/HPS20000TL/HPS30000TL
Dimension (W/H/D)	475x675x230mm
Weight	60kg
Environment temperature	-40 °C... +60 °C
Protection degree	IP65
Standby consumption	<20W
Cooling	Forced-air
Noise emission	<65dB(A)@1m
Display	Touch screen
Communication interface	RS485/CAN/4G/WiFi

8.2 Warranty

The warranty period of this product is one year. If the contract stipulates otherwise, the contract shall prevail. During the warranty period, ATESS products shall promptly present the invoice and date of purchase of the products to ATESS Service personnel during maintenance. At the same time on the product the nameplate logo should be clearly visible, otherwise it will not be repaired.

Warranty condition

ATESS will repair or replace the product free of charge during the warranty period; the faulty machine after replacement shall be owned by ATESS; the customer shall reserve a certain amount of time for ATESS to repair the faulty machine.

Liability exemption

The following circumstances arise, the company has the right not to carry out quality assurance:

Products without the ATESS logo.

The product or component has exceeded ATESS Warranty period.

Failure or damage caused by non-product working environment or incorrect installation, storage and use (such as excessive temperature, too low temperature, too humid or dry, high altitude, unstable voltage or current, etc.)

Failure or damage caused by the installation, repair, modification or disassembly of non-ATESS after-sales service personnel, except for after-sales commission.

Failure or damage caused by the use of non-ATESS components; due to accidents or human causes (operational errors, scratches, handling, bumps, improper voltage access, etc.).

Failure or damage, transportation damage; failure or damage caused by force majeure such as natural disasters (such as earthquakes, lightning strikes, fires, etc.); other failures or damages caused by the quality problems of ATESS machines (including components) themselves.