



**SHENZHEN ATESS POWER TECHNOLOGY CO.,LTD**

GROWATT-ATESS Industrial Park, No.23 Zhulongtian Road, Shuitian Community,  
Shiyan Street, Baoan District, Shenzhen

Tel: +86 755 2998 8492

Web: [www.atesspower.com](http://www.atesspower.com)

Email: [info@atesspower.com](mailto:info@atesspower.com)

Revised date: 2024-05-20



**ATESS NOVO EVA-07D-SE/PE**  
Single-phase AC EV charging station  
Quick installation guide

## **Disclaimer**

This user manual is copyrighted by ATESS Power Technology Co., Ltd. (hereinafter referred to as "ATESS" ). No company or person may extract or copy part or all of this user manual without the written permission of ATESS Power Technology Co., Ltd. Content must not be transmitted in any form, including materials and publications.

All rights reserved.

ATESS has the final right to interpret this user manual. The information in this manual is subject to change without notice.

## **Thank you for using ATESS AC EV charging station**

EVA series intelligent single-phase AC EV charging station is a power supply device that uses professional and advanced technology to provide energy supply to electric vehicles, it also has friendly man-machine interface and versatile functions of control, billing, and communication. The charger can be connected to a back-office server to realize the functions of reservation and payment via Mobile phone APP. Diversified communication options, including wired Ethernet, WIFI, 4G is available for back-office server connection.

We sincerely hope that this product can meet your needs and will continuously improve the quality of our products.

# Contents

**1** Product Description

**2** Packaging List

**3** Installation and Wiring

**4** Parameter Setting

**5** Operation instruction and LCD description

**6** Firmware update

**7** Troubleshooting

**8** Load Balancing

**9** Use excess solar power to charge your car

**10** Specification

**11** Application

**12** Warranty

**13** Annex









**14** EU Declaration of conformity

# Product Description 1

## Safety precautions

This document contains important safety information about your AC EV charging station. Please keep this file for future reference.

Please read this document thoroughly before installing and using the ATESS AC EV charging station. Failure to follow safety instructions may result in electric shock, fire, serious injury or death.

	Check the charger cable and case regularly for damage. If the product is defective or damaged, suspend use and contact ATESS for advice.
	Do not open, repair, tamper or modify the charger in any way without authorization.
	We recommend that the charger installation, inspection, etc. be carried out by qualified electricians who have obtained relevant certificates, and the installation should comply with local wiring regulations to ensure safe use.
	Ensure that the charger is in the working temperature. Do not touch the surface of the charger in high temperature environment to avoid burns.
	Do not expose any part of the equipment or cable to strong force, impact, or sharp objects.
	There may be power left within 5 minutes after the charger is powered off. Please ensure that it is completely disconnected before operating.
	You can clean the surface of the charger with a soft, damp cloth without using solvents or abrasives. Power must be off before cleaning.
	This symbol on products and accompanying items indicates that used electrical appliances and other products should not be mixed with general domestic waste. For proper handling, recovery and recycling, please take this product to the designated collection point for disposal.

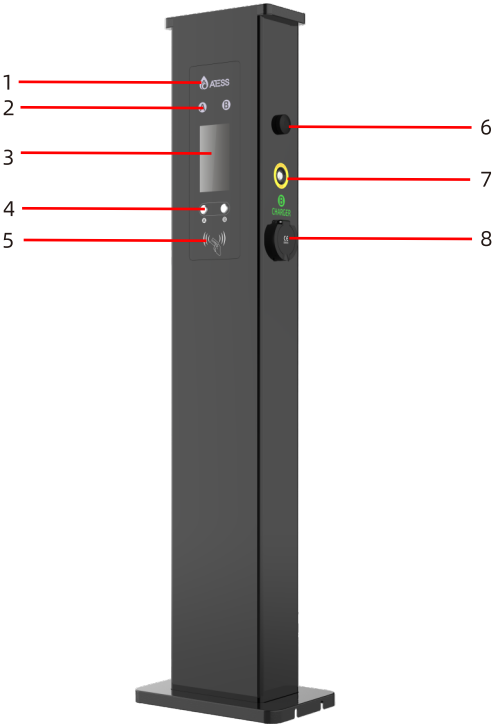

- 1. LOGO and logo backlight
- 2. A/B status indicator
- 3. LCD display
- 4. Debug button/A/B connector switch
- 5. RFID reader
- 6. WIFI/4G Antenna
- 7. Emergency stop button/AP switch button (press and hold for 10 seconds to enter AP mode)
- 8. Socket outlet (plug holder for cabled version)

## 2 Packaging List

No.	Name	Qty	Remark
1	Charger	1	
2	User manual	1	
3	Quality certificate	1	
4	User card	3	
5	M5*12, hexagon head combination screw with cross recessed cavity	4	Fixing of the upper cover of the base
6	M8*80 outer hexagon built-in implosion expansion bolt	4	Bottom bracket fixation

## Installation and Wiring 3

### 3.1 Installation on the ground

3.1.1 Open the packaging, you'll see a charge point, a user manual, a pedestal and a bag of mounting accessories. There is also an RFID card if the charge point is RFID version. For cabled version, a cable holder is also included inside.

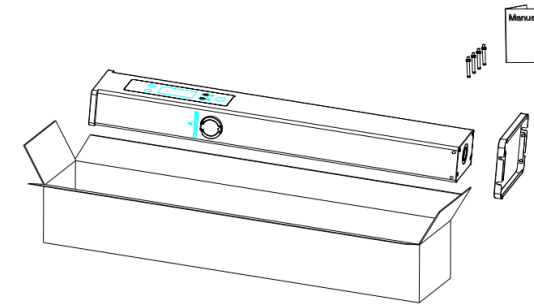

3.1.2 The charge point must be installed on a hard surface, concrete surface is recommended, it can also be mounted on a solid ground. Drill holes according to the requirements marked on the illustration for fixing expansion bolts.

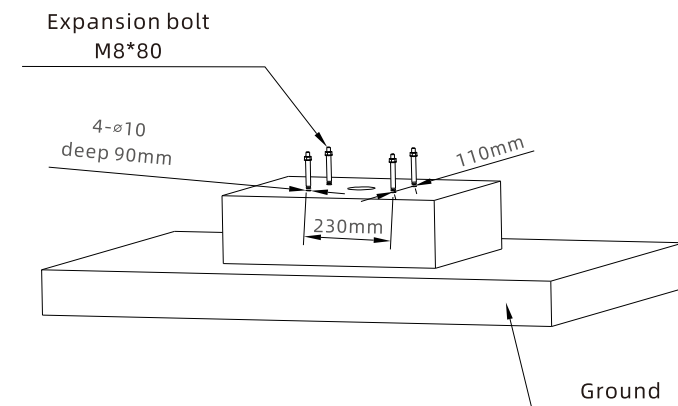

3.1.3 Fix the charge point onto the holes with expansion bolts. The input cables shall go into the pole from the bottom middle area and come out of it from the area below the cable holder.

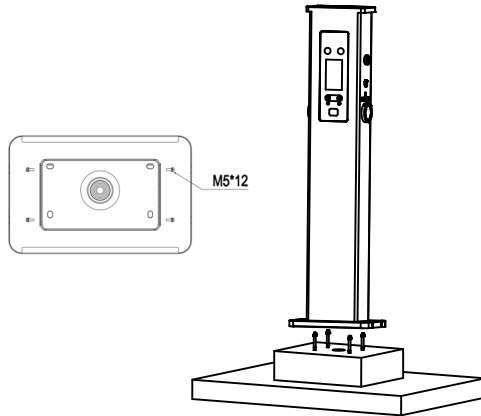

3.1.4 Crimp the below shown ring terminals on the end of the AC input wires and PE wires. Connect the wires into the terminal block of the charge point as below.

Check the wiring and then close the switch and the door.

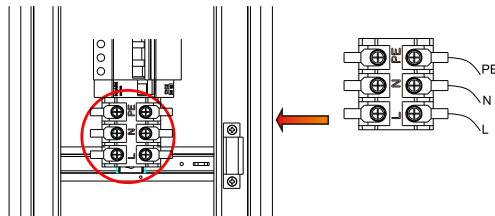

	Model	L	N	PE
Terminal	7K			
Wire		≥16mm <sup>2</sup> ≥AWG5	≥16mm <sup>2</sup> ≥AWG5	≥16mm <sup>2</sup> ≥AWG5

**Note:**

1. Only professional personnel can do the wiring, connect the AC input wires in correct phase order according to the markings on the terminal block.
2. The PE terminal shall be connected to the Earth firmly and reliably.
3. No live work! Turn off the breaker inside the charging equipment before repairing or maintaining.
4. Please do not disassemble the unit unless authorized!

## Parameter Setting 4

After the installation and wiring is done, connect the Charger to a computer and configure parameters via the web browser of the computer, then the Charger can be ready for using.

### 4.1 Set computer's IP

The Charger's default IP address is 192.168.1.5. To access the parameter setting interface, you'll need to first set the computer's IP to 192.168.1.x (x can be any value between 1 and 255 except for 5, e.g. 192.168.1.10).

To set a static IP on your Windows computer:

1. Click Start Menu > Control Panel > Network and Sharing Center. (For Windows 8 and higher, search for and open Control Panel and select Network and Internet).

2. Click Change adapter settings.

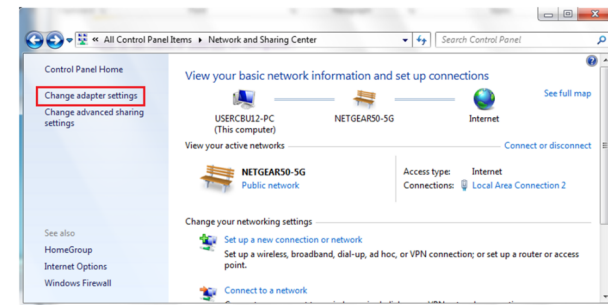

3. Right-click on Local Area Connection and click on Properties.

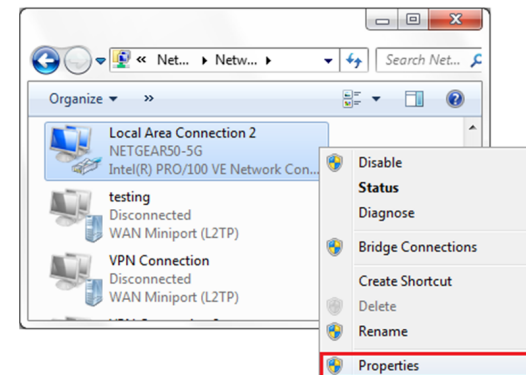

4. Select Internet Protocol Version 4 (TCP/IPv4) and click on Properties.

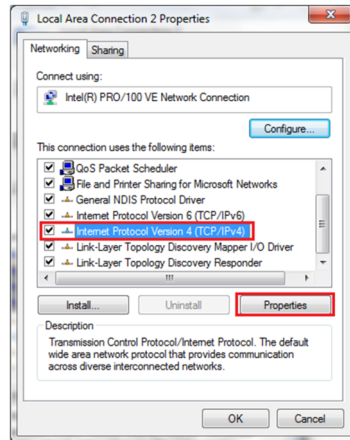

5. Select "Use the following IP address" and enter the IP address, Subnet Mask, Default Gateway. Click OK and close the Local Area Connection properties window.

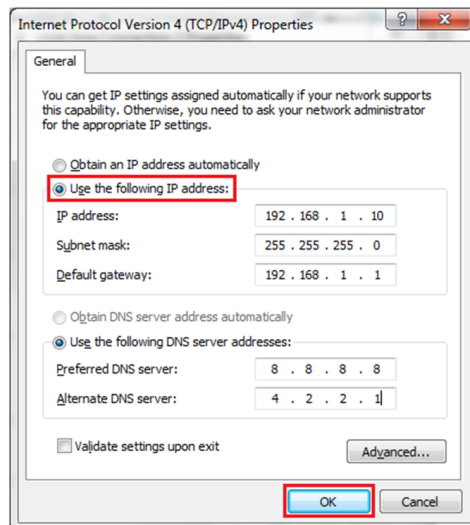

## 4.2 Configure parameters

Connect the charger to a computer via a network cable. Open the web browser and type in <http://192.168.1.5:8080/> in the address field and click enter, then enter the password: 12345678 and click enter again, the parameter setting page of the charger will open up.

Parameter setting can only be done via web browser on a computer. It is suggested to use IE or Firefox, other browser might have compatibility problem.

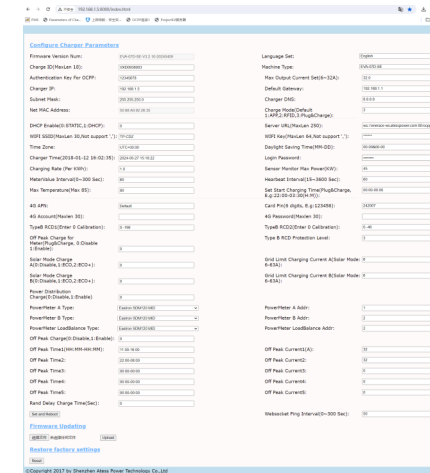

Overview of Parameter setting page

### Explanation of parameters:

(1) Firmware version of the Charger. This item cannot be modified here on the setting page.



Fig.1

(2) Charger ID, this is the unique identification of the Charger. If the charger is to be connected to ATESS back-office server, this ID must be set as the serial number on the nameplate of the Charger. Otherwise the Charger cannot be registered on the server.



Fig.2

(3) Charger IP. The default IP is 192.168.1.5. It is not suggested to change the default IP. If you have changed the default IP and forgot the new IP, you can reset the charger to factory setting by long press the reset button(the reset button on control board, not the red emergency stop button) until the charger reboot. Then you can use the default 192.168.1.5 for access.

**Please note:** After restoring the charger to factory setting, you'll need to reset the charger ID(same as serial number, can be found on the nameplate sticker) and server url, otherwise the charger won't be connected to the back-office server.

Charger IP:	<input type="text" value="192.168.1.5"/>
Default Gateway:	<input type="text" value="192.168.1.1"/>
Charger DNS:	<input type="text" value="8.8.8.8"/>

Fig.3

(4) Charger Subnet mask. The default value is 255.255.255.0. It is not suggested to change. If the subnet mask has been reset to other value and you have forgotten the new value, you can restore the charger to factory setting by long press the reset button.

DHCP Enable(0:STATIC,1:DHCP):	<input type="text" value="0"/>
Subnet Mask:	<input type="text" value="255.255.255.0"/>

Fig.4

(5) MAC address. This is the MAC address used for LAN cable connection. If the charger is connected to ATESS back-office server via LAN cable and the router has MAC access control, then you can put this MAC in the router to allow the charger to access server

Net MAC Address:	<input type="text" value="50:88:A0:92:26:35"/>
------------------	--

Fig.5

(6) Enable the DHCP mode to automatically assign IP addresses to routers and Connect to charger via network cable under internet connection.

DHCP Enable(0:STATIC,1:DHCP):	<input type="text" value="0"/>
-------------------------------	--------------------------------

Fig.6

(7)The secret key to connect to the OCPP server for authentication.

Authentication Key For OCPP:	<input type="text" value="12345678"/>
------------------------------	---------------------------------------

Fig.7

(8) WiFi SSID(wireless network name) and WiFi Key(WiFi password) is used for WiFi connection

WIFI SSID(MaxLen 30,Not support ','):	<input type="text" value="WIFI_Default"/>
WIFI Key(MaxLen 64,Not support ','):	<input type="text" value="....."/>

Fig.8

(9)Server URL is to set the domain name or IP address of the back office server to be connected.

The domain name of ATESS server is "ws://enerace-ws.atesspower.com/ocpp/ws" .  
IP address is "ws://47.56.208.172:80/ocpp/ws" .  
Heartbeat Interval is used for testing. No need change.

Server URL(MaxLen 250):	<input type="text" value="ws://enerace-ws.atesspower.com:80/ocpp/ws"/>
Heartbeat Interval(15~3600 Sec):	<input type="text" value="60"/>

Fig.9

(10) Time of the charger. Set according to the local time. After the charger is connected to back-office server, the time will be synchronized with the server's time. If the charger has no server connection, then you'll have to reset the time every time you turn off and back on the charger.

Time Zone:	<input type="text" value="UTC+00:00"/>
Charger Time(2018-01-12 16:02:35):	<input type="text" value="2024-05-27 15:18:22"/>

Fig.10



(11) Login password is used for web page login parameter settings,the default password is 12345678.

Login Password:	<input type="password" value="....."/>
-----------------	--

Fig.11

(12) Over temperature protection value, not suggested to change.

Max Temperature(Max 85):	<input type="text" value="80"/>
--------------------------	---------------------------------

Fig.12

(13)Interval for uploading metering data during charging, keep the default value.

MeterValue Interval(0~300 Sec):	<input type="text" value="60"/>
---------------------------------	---------------------------------

Fig.13

(14)4G connection, when the 4G network cannot be connected, login SIM card APN and other information

4G APN:	<input type="text" value="Default"/>
4G Account(Maxlen 30):	<input type="text"/>
4G Password(Maxlen 30):	<input type="text"/>

Fig.14

(15) DC residual current sampling value calibration. Enter 0 and press “Set and Reboot ” to calibrate the DC RCD ring. Display real-time detection value of DC residual current.keep the default RCD level.

TypeB RCD1(Enter 0 Calibration):	<input type="text" value="0.85"/>
TypeB RCD2(Enter 0 Calibration):	<input type="text" value="0.13"/>
Type B RCD Protection Level:	<input type="text" value="3"/>

Fig.15

(16) For the charger with an integrated meter, set the meter model and address and keep the default value.

PowerMeter A Type:	<input type="text" value="Eastron SDM120 MID"/>
PowerMeter B Type:	<input type="text" value="Eastron SDM120 MID"/>
PowerMeter A Addr:	<input type="text" value="1"/>
PowerMeter B Addr:	<input type="text" value="2"/>

Fig.16

(17)Set low electricity prices for charging time to reduce costs.

Off Peak Charge(0:Disable,1:Enable):	<input type="text" value="0"/>
Off Peak Time1(HH:MM-HH:MM):	<input type="text" value="11:00-16:00"/>
Off Peak Time2:	<input type="text" value="22:00-08:00"/>
Off Peak Time3:	<input type="text" value="00:00-00:00"/>
Off Peak Time4:	<input type="text" value="00:00-00:00"/>
Off Peak Time5:	<input type="text" value="00:00-00:00"/>
Off Peak Current1(A):	<input type="text" value="32"/>
Off Peak Current2:	<input type="text" value="32"/>
Off Peak Current3:	<input type="text" value="0"/>
Off Peak Current4:	<input type="text" value="0"/>
Off Peak Current5:	<input type="text" value="0"/>

Fig.17

(18) Relieve the power grid pressure, authorized charging, after the set time to start.

Rand Delay Charge Time(Sec):	<input type="text" value="0"/>
------------------------------	--------------------------------

Fig.18

(19) Open the function, the user's home meter provides dry contact signal, identify the off-peak period, reduce the charge of electricity

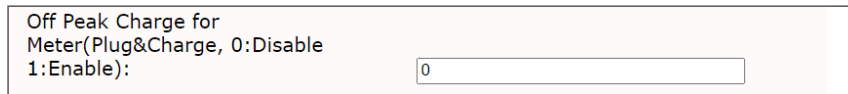

Off Peak Charge for Meter(Plug&Charge, 0:Disable, 1:Enable): 0

Fig.19

(20) Loadbalancing, sets the total power input of the home grid to avoid tripping.

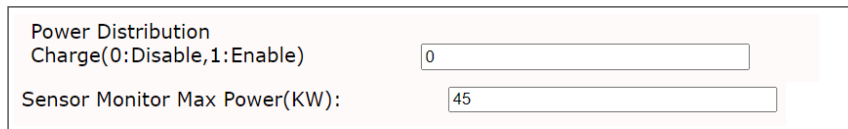

Power Distribution Charge(0:Disable,1:Enable): 0  
Sensor Monitor Max Power(KW): 45

Fig.20

(21) To set the working mode of solar, the ECO mode requires setting the KWH of electricity obtained from the grid.

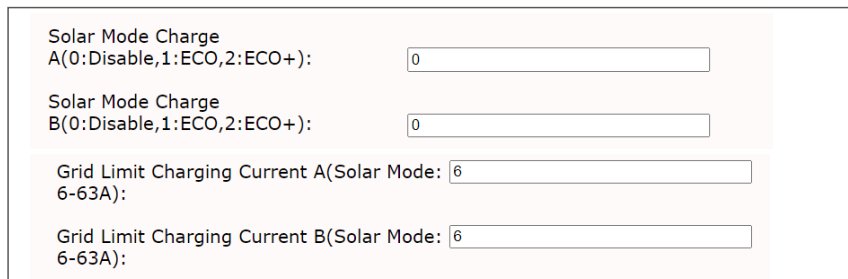

Solar Mode Charge A(0:Disable,1:ECO,2:ECO+): 0  
Solar Mode Charge B(0:Disable,1:ECO,2:ECO+): 0  
Grid Limit Charging Current A(Solar Mode: 6-63A): 6  
Grid Limit Charging Current B(Solar Mode: 6-63A): 6

Fig.21

(22) Set the load balancing or Solar function, sampling instrument type and address.

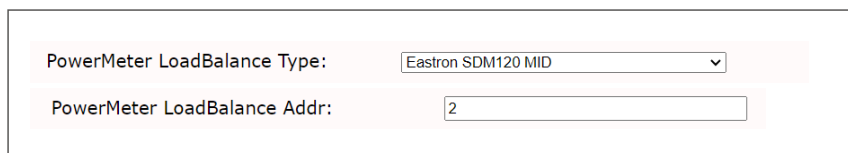

PowerMeter LoadBalance Type: Eastron SDM120 MID  
PowerMeter LoadBalance Addr: 2

Fig.22

(23) Set the display language of the charger LCD.



Language Set: English

Fig.23

(24) The charger model, can not be modified, factory default.



Machine Type: EVA-07D-SE

Fig.24

(25) Set the output current of the charger to limit the output power of the charger.

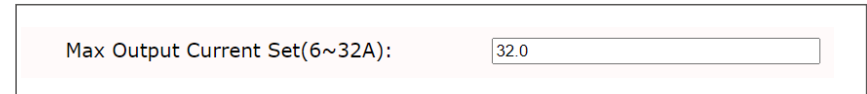

Max Output Current Set(6~32A): 32.0

Fig.25

(26) Charging mode setting. 1: APP/RFID mode; 2: RFID mode; 3: Plug&Charge mode.



Charge Mode(Default 1:APP,2:RFID,3:Plug&Charge): 3

Fig.26

(27) PIN of the charger, used to verify the PIN of user card. To use a RFID card with the charger, their PIN must be consistent. If the user card has a different PIN, then it cannot be used on this charger. The default PIN setting of the charger is 242007.



Card Pin(6 digits, E.g:123456): 242007

Fig.27

(28) Set the tariff for charging energy.

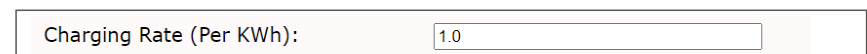

Charging Rate (Per KWh): 1.0

Fig.28

(29) Set daylight saving time for the charger to switch automatically.



Daylight Saving Time(MM-DD): 00-00&00-00

Fig.29

# Operation instruction and LCD 5 description

(30) The time for automatic charging in Plug and charge mode.

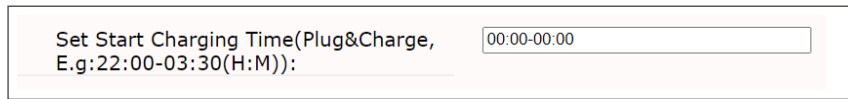

Fig.30

(31) The communication interval between the charger and server, keep the default value.



Fig.31

(32) After modifying any parameters, click "Set and Reboot" to take effect. Some parameters may cause the charger to automatically restart.



Fig.32

(33) Upgrade the firmware of the charger. After clicking upload, the charger will restart.

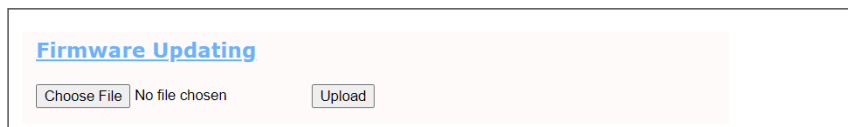

Fig.33

(34) Restore the charger to factory Settings.



Fig.34



## 5.1 Charging mode and Operation

### APP/RFID mode:

Initiate or cease charging by scanning QR code using APP or by swiping RFID card. You can also use APP for reservation and payment provided that the back-office server supports such functions.



APP/RFID mode operation process flow

If you are using the ATESS APP, Charging can be started/stopped by pressing the "  /  " button on the APP.

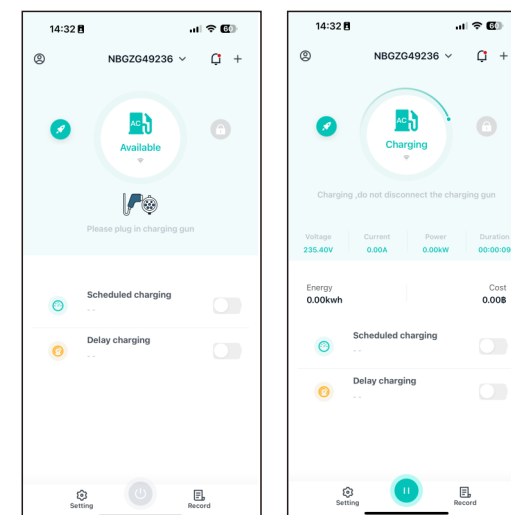

**RFID mode:**

Charging can only be initiated or ceased by swiping RFID card

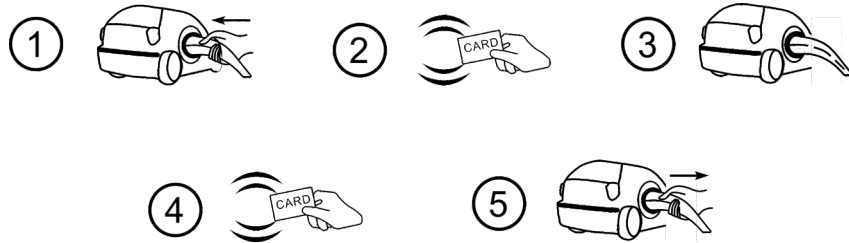

RFID mode operation process flow

**Plug & Charge:**

Connect the charger to the EV. The charger will start charging automatically. Once charging is complete, the charging station will automatically stop, and the user can safely remove the charging plug. If you wish to stop charging early, press the silver emergency stop button on the right, and the charger will halt output. Or stop charging by operating your electric vehicle.

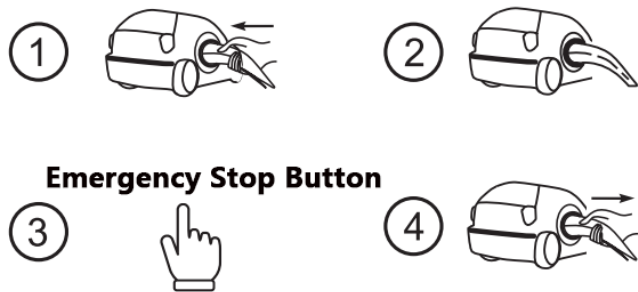

Plug & Charge mode operation process flow

**5.2 LCD interface introduction**

	<p>Interface of stand by status. Charging mode is displayed in the lower right corner of the screen.</p>
	<p>Interface of user card information Displayed for user to check card ID and balance when swiping RFID card while EV is not connected</p>
	<p>Interface of charging status. Displayed when the charging is being carried out. There is charging time, consumed electricity, charging cost on it, as well as real-time charging voltage and charging current.</p>
	<p>Interface of charging complete. Displayed when the electric vehicle stops charging or the charging pile stops charging.</p>
	<p>Interface of reserved status. If the back-office server and APP support reservation function and the charger is reserved, this interface will come out showing user ID and remaining time to reserved time.</p>
	<p>Interface of fault status. Displayed with fault code and fault description when fault occurs.</p>



Press A and B buttons 10s at the same time to enter the debugging interface, you can view IP/serial number and other information. Press either button AB to exit the screen.

## 6 Firmware Update

There are 2 ways to update firmware for EV charger

1. Update by SD card
2. Update on parameter setting page

### 6.1 Update by SD card

The firmware file must be named as "App.bin" .

1. Prepare a micro SD card with capacity not greater than 4GB. Format the SD card using FAT32.

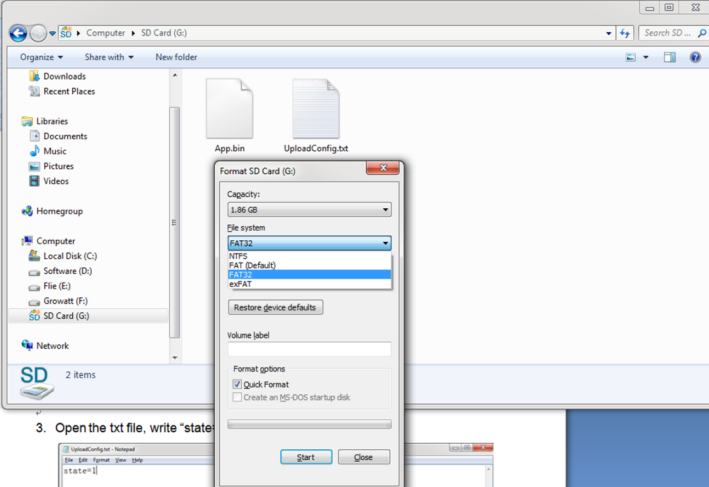

3. Open the txt file, write "state=1"

2. In the root directory of the SD card, rename the firmware file as "App.bin" . And create a txt file with name of "UploadConfig.txt" .

App.bin	2018/12/5 15:58	BIN 文件	168 KB
UploadConfig.txt	2018/12/6 15:04	文本 文档	0 KB

3. Open the txt file, write "state=1" in it and save the file.

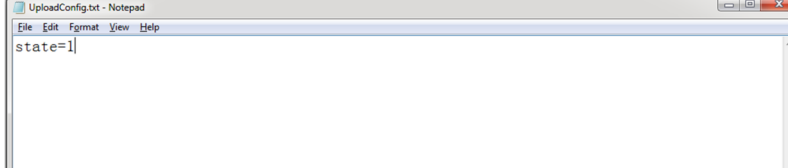

4. Turn off the charger and insert the SD card into the charger, the update will start automatically. The indicator will first flash red and then flash green with a long beep as the end of the update(sometimes the beep sound may not be clearly heard). After the update is done, turn off the charger and remove the SD card.

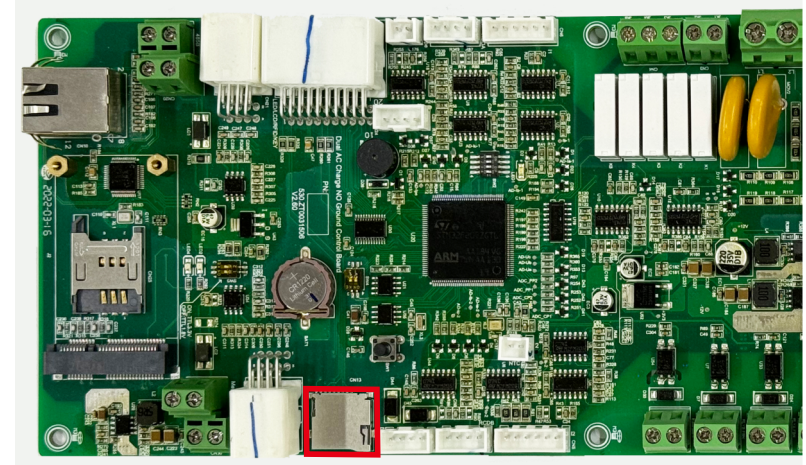

Micro SD slot of dual output charger

5. Check the current FW version on LCD or the parameter setting page.

To check FW version on the parameter setting page

Connect the charger to computer via a network cable, the computer's IP must be within the 192.168.1.x segment(x is any value between 1 and 255 except 5).Open the web browser, type in the charger's default IP of "http://192.168.1.5:8080" and click enter, then you can check the firmware version on the appeared parameter setting page.

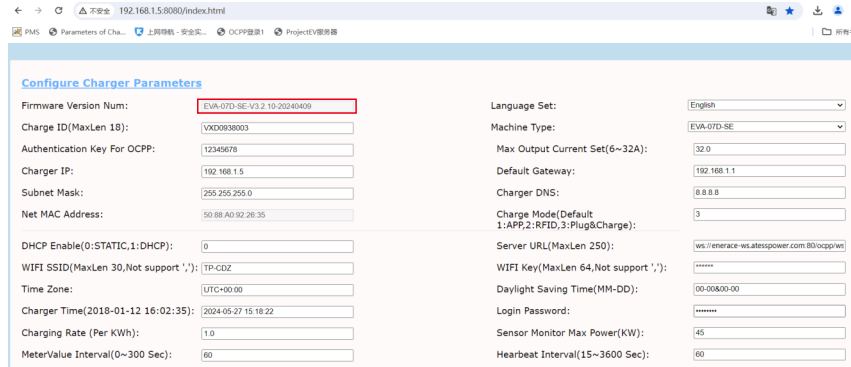

## 6.2 Update on parameter setting page

Using this method for update doesn't require any specific name for the firmware file.

1. Connect the charger to a computer with IP address set as 192.168.1.x(x can be any value between 1 and 255 except 5) via a network cable. Open web browser and type in the charger's default IP address-<http://192.168.1.5:8080>, then enter the password 12345678 and click enter,you'll get into the parameter setting page.

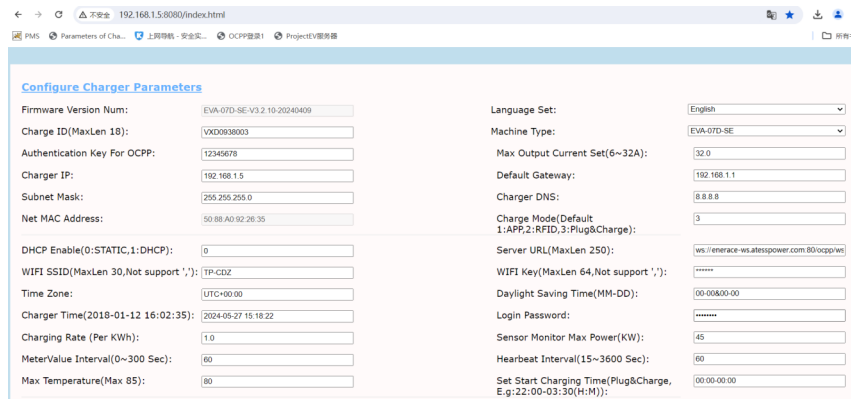

2. Scroll down to the below field.



3. Click the "browse" button and select the firmware file. Click "Upload", then update will start automatically.



During the update, the LED indicator will behave as below:

First flash red and goes out with a short beep sound, during this period the firmware file is transmitted to the charger's flash memory from the computer.

Then flash red again for some seconds and quickly change to green light flashing. During this period, the charger is updating the firmware to its micro controller.

When the greenlight goes out, there will be a long beep sound. That means the firmware is successfully updated.

The beep sound may not be audible with the front cover fixed on the charger

If the update doesn't start after click "Upload", Turn off and back on the charge to try again.

4. You might see below content. If the charger is already successfully reboot after the firmware update, close the browser and open it again to check the current firmware version.

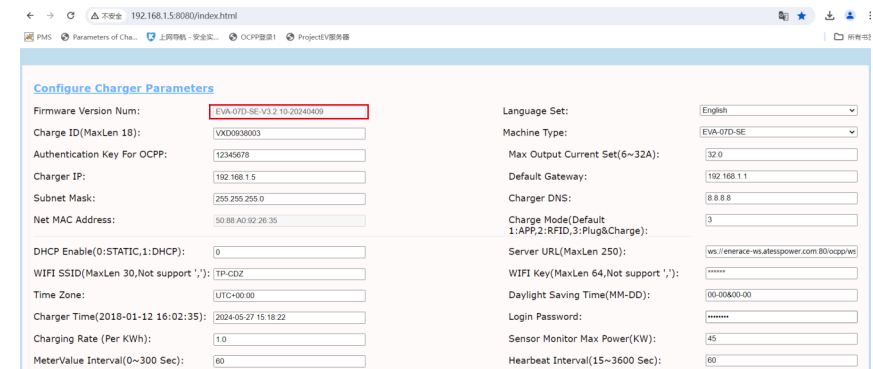

# 7 Troubleshooting

## 7.1 Troubleshoot by LED behavior or LCD display

If fault occurs, users can check the fault information on the LCD or by the number of blinks of the LED indicator light. Each fault is indicated with a sequence of different numbers of LCD blinking. A pause of 3 seconds between each sequence indicates the beginning or end of a sequence. If multiple faults happen at the same time, each sequence of blinking shows in chronological order at an interval of 3 seconds.

Please see the table below for detail information

No.	Error code	Number of flashes	Fault description
1	100	3	The emergency stop button is pressed
2	101		Reserved
3	102		Reserved
4	103		Reserved
5	104		Reserved
6	105	1	Over voltage on phase L1
7	106	2	Under voltage on phase L1
8	107		Reserved
9	108	4	Over current
10	109	5	Over temperature
11	110	6	DC leakage current detected
12	111	7	RS485 communication fault
13	112	8	Reserved
14	113	9	Type A Switch Fault
15	114	10	Relay Fault
16	115	11	PE fault
17	116	12	PEN fault
18	117	13	In maintenance
19	118	14	Microswitch faulty. Door opened will display fault

## 7.2 Firmware update fails

### 7.2.1 Firmware update failure with SD card:

- Check if the capacity is over 4G bytes, please use a SD card of less than 4GB to retry.
- Check if the SD card is formatted with FAT32.
- Check if the firmware file is renamed as App.bin.
- Check if you have filled in "state=1" in the UploadConfig.txt file.

### 7.2.2 Firmware update failure with laptop:

Please try with IE browser. Or reboot the laptop to retry.

## 7.3 WiFi connection&APP issue

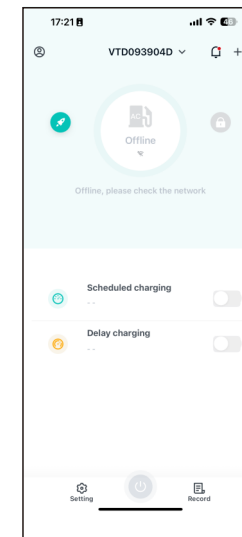

### a. Check WiFi signal strength:

Signal strength on PC:



Signal strength on mobile:



b. Please check and input the correct WiFi SSID and password to retry.

Configure Charger Parameters

Firmware Version Num: EVA-07D-SE-V3.2.10.20240409 Language Set: English

Charge ID(MaxLen 18): VXD0938003 Machine Type: EVA-07D-SE

Authentication Key For OCPP: 12345678 Max Output Current Set(6~32A): 32.0

Charger IP: 192.168.1.5 Default Gateway: 192.168.1.1

Subnet Mask: 255.255.255.0 Charger DNS: 8.8.8.8

Net MAC Address: 50:88:A0:92:26:35 Charge Mode(Default: 1:APP,2:RFID,3:Plug&Charge): 3

DHCP Enable(0:STATIC,1:DHCP): 0 Server URL(MaxLen 250): ws://emerce-wi-attestpower.com:80/ocpp/wi

**WiFi SSID(MaxLen 30,Not support ',): 1 TP-C0Z** **WiFi Key(MaxLen 64,Not support ',): \*\*\*\*\***

Time Zone: UTC+00:00 Daylight Saving Time(MM-DD): 00-00&00-00

Charger Time(2018-01-12 16:02:35): 2024-05-27 15:18:22 Login Password: \*\*\*\*\*

Charging Rate (Per KWh): 1.0 Sensor Monitor Max Power(KW): 45

If you check the WiFi setting on the APP, please turn off and back on the charger and connect your mobile to the WiFi emitted by the charger for checking and setting.

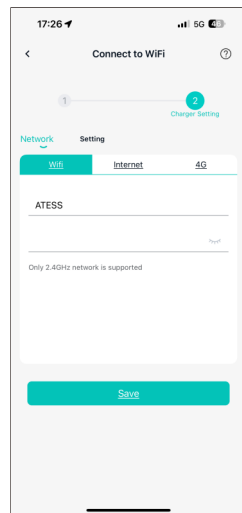

c. Check if there is access control in the router, e.g. MAC filtering, port blocking, etc.

To verify this, you can use your mobile phone to create a hotspot and try to connect the charger to this mobile hotspot. If charger can connect to the hotspot, but cannot connect to the router, there must be access control in the router, please check with the site owner for this.

Check if charger is connected on Device list of the hotspot setting page

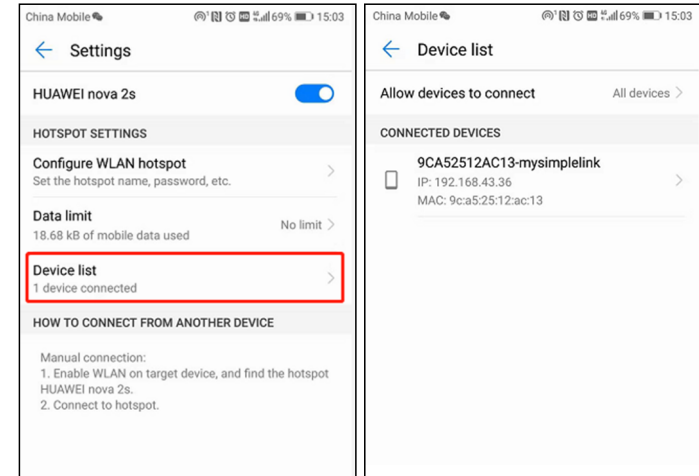

1. Some routers have 2 WiFi, one is 2.4GHz, the other is 5GHz. Most homes just use the 5GHz WiFi as their default WiFi. But the charger can only connect to the 2.4GHz WiFi. So if the charger can connect to your mobile phone hotspot, but cannot connect to the home WiFi. Please check with the home owner or check on their router to see if you are using the 5GHz WiFi. Please do use the 2.4GHz WiFi for charger connection.

2. When the WiFi signal strength is lower than -75dbm, the charging point will not be able to connect with WiFi.

(1) Download the WiFi signal strength test tool from the app store to check whether the WiFi signal strength connected to the charging point is greater than -75dbm.

(2) If the WiFi signal strength is weak, it is recommended to use AP repeater to increase the signal strength, which can enlarge the WiFi signal range.

Wireless	Enabled
Wireless Network Name (SSID)	SKYE2496 (2.4 GHz), SKYE9689 (5 GHz)
Wireless Network Visible	Yes
Current Wireless Channel	13 (2.4 GHz), 36 (5 GHz)
Wireless Encryption	WPA2-PSK

Devices connected to your home network

Device Name	MAC Address
UNKNOWN	70:70:0d:d5:bce5
iPhone	88:e8:7f:9e:2f:ac
23C01K568FILDUIZ	20:47:47:3d:85:f4
HUAWEI_nova_2s-8ed52a8f95	ec:89:14:40:3b:9c
iPhone	a8:5c:2c:30:d7:07
Priyas-iPad	78:7e:61:c3:f7:03
LATTITUDE-05	34:e1:2d:b5:c7:fa
Priyas-iPhone	b8:53:ac:4d:05:50
UNKNOWN	40:99:22:2a:fc:93
UNKNOWN	00:1b:67:16:d7:82





e. Check if the charger is still connected to the computer. Please unplug it from computer otherwise the charger won't connect to the back-office server.

f. Check if server address is correct in the "Server URL" field. The correct setting is : ws://enerace-ws.atesspower.com/ocpp/ws

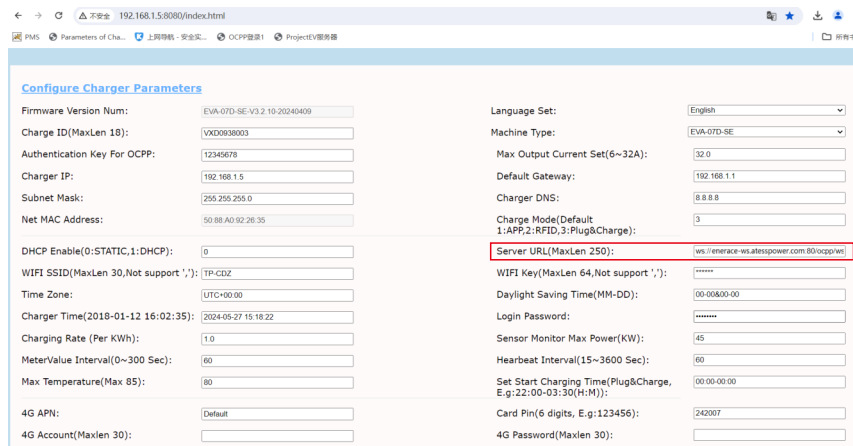

## 7.4 Cannot access parameter setting page

a. Check if you have connected the charger to your computer,

b. Check if you have change the computer's IP to 192.168.1.x(x can be any value between 1 and 255 except 5).

To set a static IP on your Windows computer:

(1). Click Start Menu > Control Panel > Network and Sharing Center. (For Windows 8 and higher, search for and open Control Panel and select Network and Internet).

(2). Click Change adapter settings

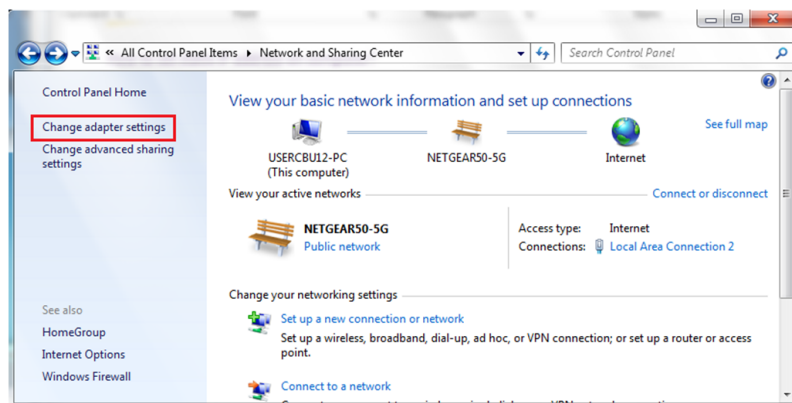

(3). Right-click on Local Area Connection and click on Properties.

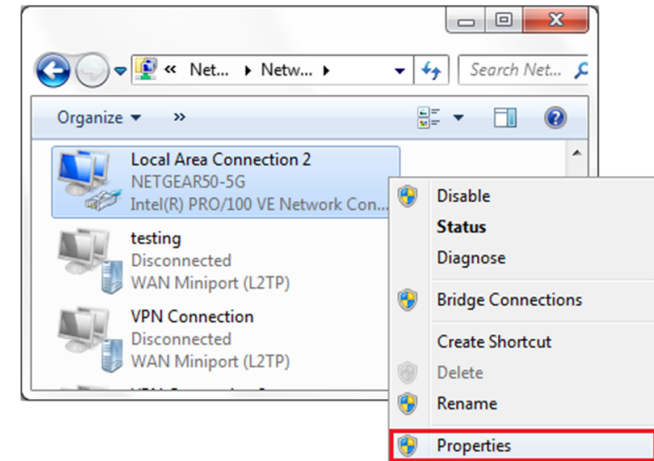

(4). Select Internet Protocol Version 4 (TCP/IPv4) and click on Properties.

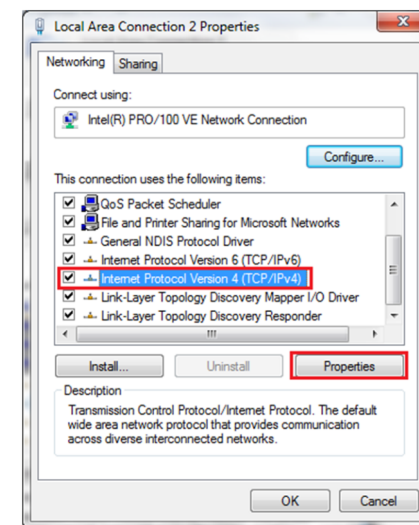

(5). Select "Use the following IP address" and enter the IP address, Subnet Mask, Default Gateway. Click OK and close the Local Area Connection properties window.

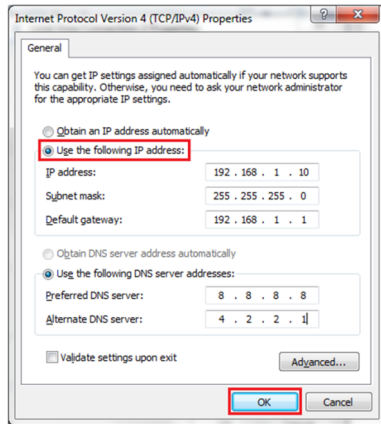

c. Check what web browser is being used, it's suggested to use Firefox or IE, Chrome cannot be used to update firmware.

d. Check if you have input the complete content, which is `http://192.168.1.5:8080`, in the address field, do not leave out the `http://` or the `":8080"`.

e. Sometimes you may need to restart the charger to access its parameter setting page.

f. If you have changed the charger's IP to other value and cannot remember, you can restore the charger to factory setting by long press the reset button. Then you can access it using `http://192.168.1.5:8080`

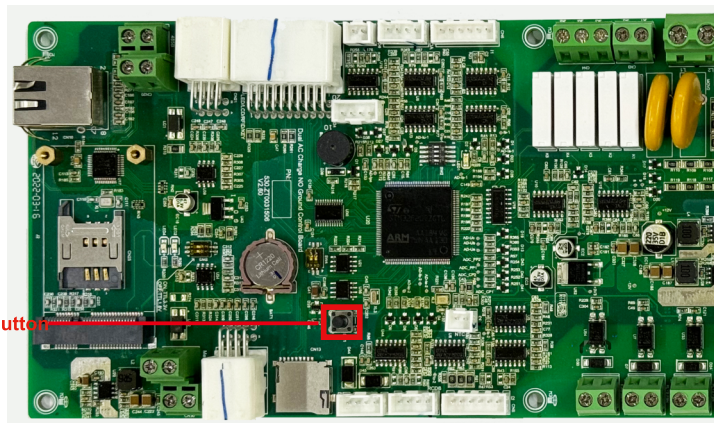

**Please note:** After restoring the charger to factory setting, you'll need to reset the charger ID and server URL, otherwise the charger won't be connected to the back-office server.

## 7.5 Charging issue

If charging cannot start after the car is plugged in.

- Check if the red emergency stop button is pressed.
- Check what charge mode is being used.

**APP/RFID:** Charge can only be started/stopped by APP or RFID card, and the charger must be connected to the back office server already.

**RFID:** Charge can only be started/stopped by RFID card.

**Plug & Charge:** Charge will start automatically when car is plugged in.

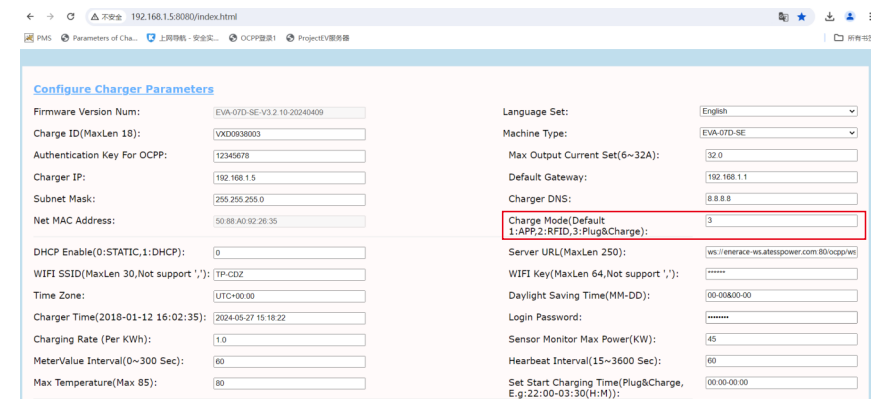

c. Check if off-peak charging is set and if charger's time is correct.

If off-peak charging is set, charge can only start within the charging allowed time period.

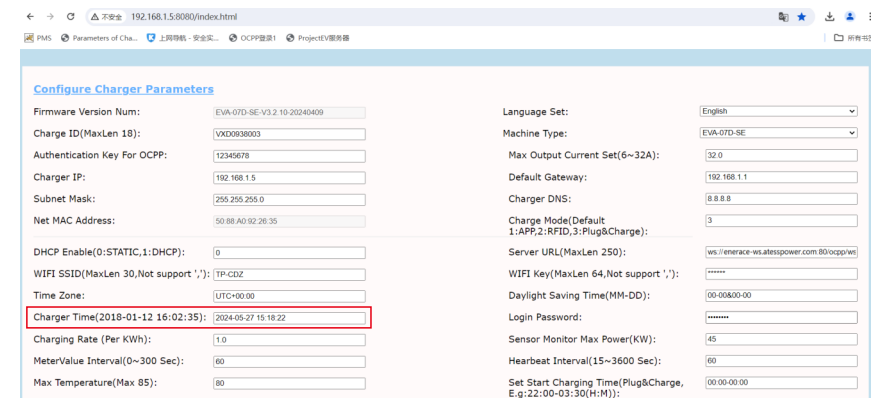

# 8 Load Balancing

## Introduction

The charge point can monitor the total power consumption of the household during charging. If the power consumption approaches the preset max value, the charge point will reduce charge power to avoid the situation of main breaker trip due to overload. It will adjust the charging power dynamically and in real-time thus the car can always be charged with the maximum allowable power.

### 8.1 Meter is needed to detect the power import, please wire it as below:

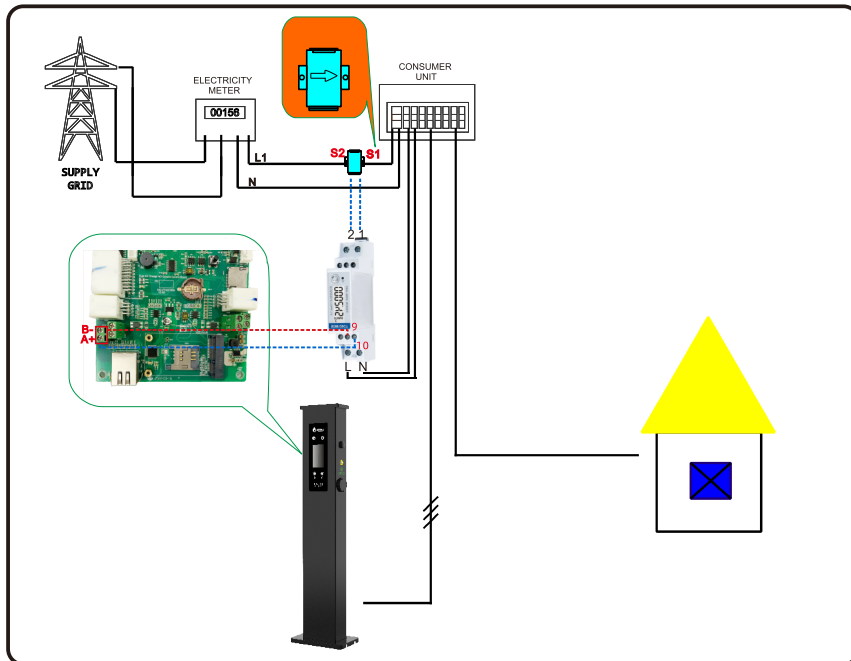

### 8.2 Parameter configuration for this function

- (1) Connect the charge point to a laptop with a network cable, access the parameter setting page on the web browser of the laptop.
- (2) Scroll down to find the following parameter: Power Distribution Enable(0:Disable, 1:Enable) and set it to 1 to activate the power modulation function.

Power Distribution Charge(0:Disable,1:Enable)	<input type="text" value="0"/>
---	--------------------------------

- (3) Set the maximum power import value in the field of External Max limit Power(kW). To avoid nuisance tripping of the main breaker, it is suggested to set this parameter slightly lower than the max supply power of the property. e.g. the max supply power is 15kW, you can set the max power import to 13kW or 14kW.

Sensor Monitor Max Power(KW):	<input type="text" value="45"/>
-------------------------------	---------------------------------

- (4) Change Power Meter Addr to the address shown on the meter, such as 2 shown in the figure below.

PowerMeter LoadBalance Type:	<input type="text" value="Eastron SDM120 MID"/>
PowerMeter LoadBalance Addr:	<input type="text" value="2"/>

## 9 Use excess solar power to charge your car

The charge point can work with grid-tied solar system, to detect and use the residual solar power to charge your car that otherwise would be fed back to grid. This can help increase the self-usage rate of the solar system and reduce electricity bill for the household.

The charge point supports 3 charge modes with grid-tied PV system: FAST, ECO and ECO+.

### 9.1 Introduction to the 3 modes for solar charge

**FAST Mode:** Charge at the rated power, the car can be fully charged in the shortest time at this mode.

#### ECO Mode:

(1) Solar function set the power p range: PE stands for rated power, P1 stands for Power Transferred to Power Grid by Photovoltaic.

1. The power of three-phase charger belongs to (5.3kW-Pe).
2. The power of single-phase charger belongs to (1.8kW-Pe).

(2) The condition of changing duty cycle of charger: P2

1. The power of three-phase charger  $P2=1000W$
2. The power of single-phase charger  $P2=500W$

(3) Operation mode:

1. when Initial charging, Permissible output power of charger  $P3(P3 = P)$
2. If  $P1 < P2$ , Permissible output power of charger  $P3.(Pe \geq P3 \geq P)$
3. If  $P1 \geq P2$ , Charger will Increase Permissible Output Power, When detected during this process  $P1 < P2$  or  $P3=PE$ . Charger will stop increasing allowable output power, now the allowable output power of charger  $P3.(Pe \geq P3 \geq P)$

#### ECO+ Mode:

In this mode, the charging point only uses the electricity sent by the photovoltaic inverter to charge the electric vehicle. When the current sent by the inverter is less than 6A, the charging point will stop charging. Please choose this mode carefully.

### 9.2 Wiring

To monitor the real-time power import and export, a meter is needed for this function to work properly.

If meter is used, the wiring will be as below.

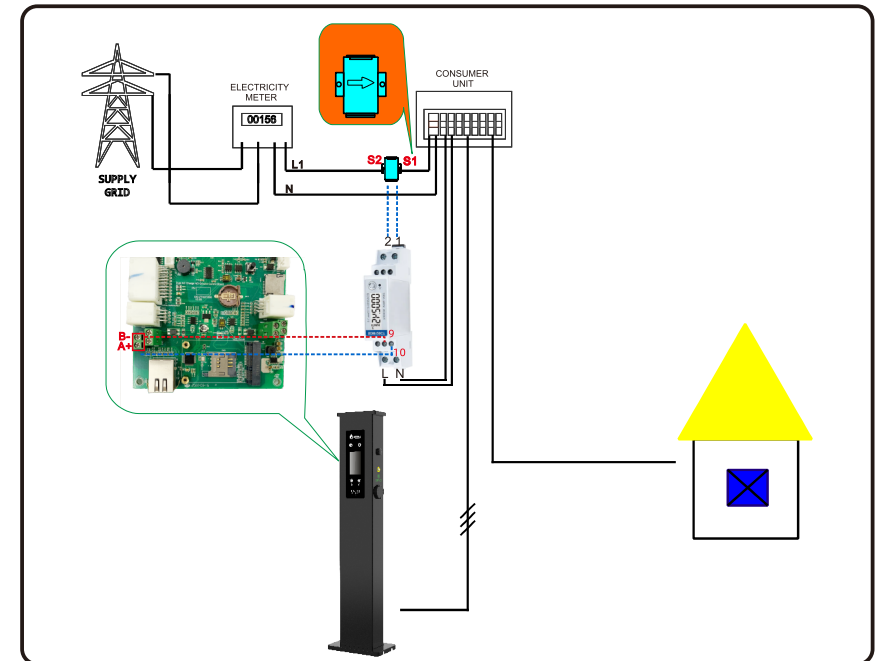

### 9.3 Parameter configuration for this function

(1) Connect the charge point to a laptop with a network cable, access the parameter setting page on the web browser of the laptop.

(2) Scroll down to find the following parameters: Solar Mode, FAST, ECO or ECO+.

Solar Mode Charge A(0:Disable,1:ECO,2:ECO+):	<input type="text" value="0"/>
Solar Mode Charge B(0:Disable,1:ECO,2:ECO+):	<input type="text" value="0"/>

(3) Select the type of meter and enter the address on the meter screen

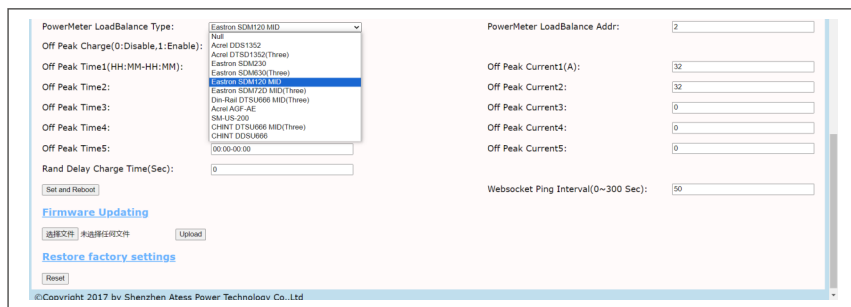

Model	NOVO EVA-07D-SE/PE
Dimension(mm)	420*270*1639(L*W*H)
Weight(kg)	<23
Display	LCD(OPT)
Casing Material	Stainless steel&Engineering plastics&Tacrlyic
Input	
Voltage	AC 230V
Output	
Voltage	AC 230V
Max current	32A*2
Ingress protection	IP55 / IP65
Working environment temperature	-25°C ~ +50°C
Relative humidity	5%~95%
Altitude	≤2000m
Frequency	50/60Hz
Communication	Ethernet / WiFi / 4G
Charging mode	APP/RFID/Plug and Charge
Standby power	<8W
Standard	EN 62196-2; EN 61851
Mounting	Ground
Certificate	CE/RCM
Protection features	
Overvoltage	260V
Undervoltage	190V
Overcurrent	35.2A
Short circuit	Yes
Leakage protection	Type A 30mA+6mA DC RCD
Over temperature	Yes
Lightning protection	Type II

# 11 Application

## 11.1. APP Introduction

### 11.1.1 Description

EneRace is an app for controlling charger. It can help you quickly and easily charge your vehicle with a EV charger.

### 11.1.2 Main Function of EneRace

- (1) The APP can push the transfer information of the charger.
- (2) The user can control the start and stop of the charger through the APP.
- (3) The user can preset the charging scheme and scheduled charging.
- (4) The user can modify the parameter settings of the charger.
- (5) Users can authorize other users to use their own charger.
- (6) The user can view the charging record and report to email.
- (7) Users can manage and set up their own accounts.

### 11.1.3 Performance

APP has good ease of use and reliability, and guarantees the security and confidentiality of information.

## 11.2. Instructions

### 11.2.1 APP download and install

Users can install EneRace by scanning the below QR code or download it from the APP store(IOS) or GooglePlay(Andriod).



### 11.2.2 Registration and login

When the user first visits, the user registration is performed by the following steps: Click the desktop icon Login page Register. When the user has an account, you can directly enter the user name and password to log in. If you forget the password, you can click the login page, forget the password button, and follow the prompts to retrieve the password through the mailbox.

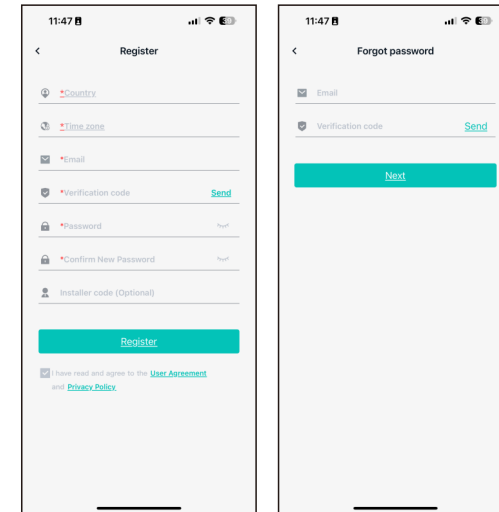

### 11.2.3 Add Charger

If you use ATS Charge for the first time, you need to add charger in the APP to facilitate setting and controlling the charger. The process of adding a charger is as follows: Click "Add" to add a charger by scanning the QR code (LCD/nameplate) or entering the charger ID. you can check the QR code/Bar code on the side window nameplate.

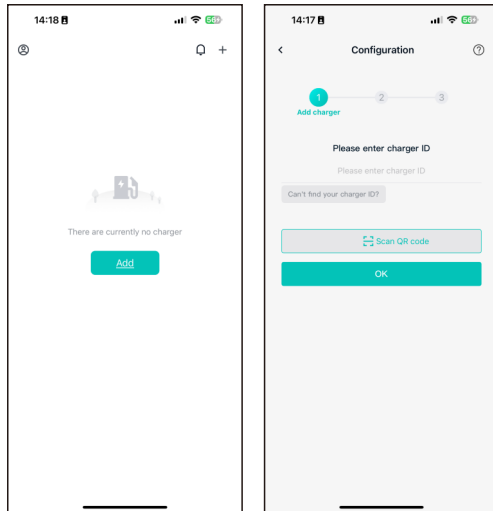

### 11.2.4 Charger switch and delete

When you have multiple chargers, you can switch chargers by clicking the arrow. A list of chargers can be found in the account information, swipe left to delete.

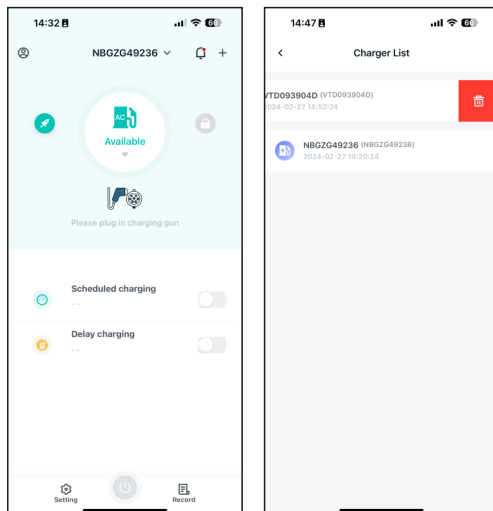

### 11.2.5 Start and stop control of charger

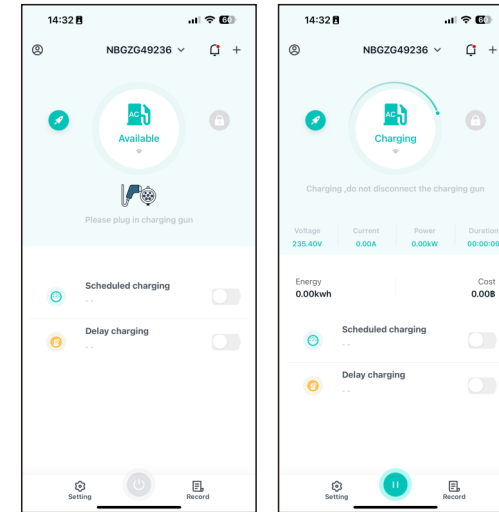

Press "  /  " to turn on / off.

**Note:** when charger status is Preparing , you can press  to start charging.

### 11.2.6 Cable locked

For chargers in the socket version, the connector can be unlocked via this button after setting up the manual unlock function

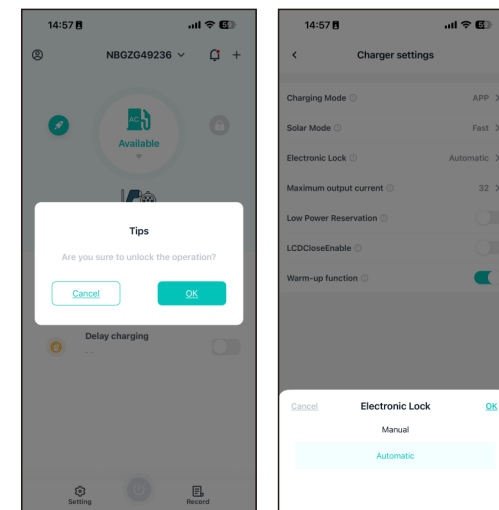

### 11.2.7 Charging record

Press "Record" to view past charge records, including charger ID, gun number, time, energy, cost and so on. You can also view the energy consumption curve over time, and download the charging report to your email or local reference.

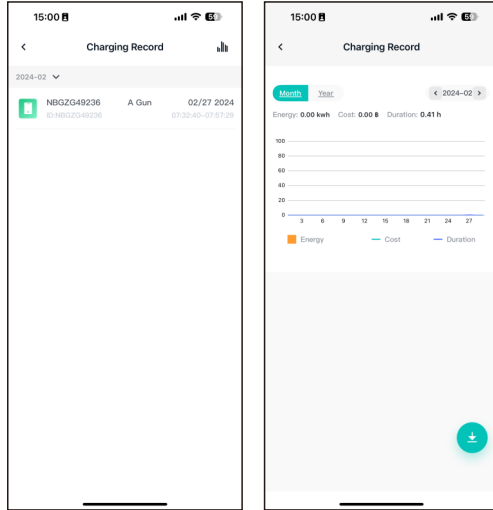

### 11.2.8 Preset charging scheme

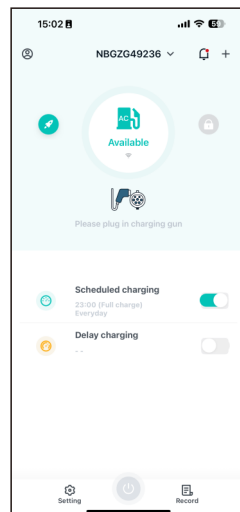

There are three Pre-set charging schemes: Duration, Amount and Energy. Users can choose one of these options. The scheme can be canceled before the start charging time is reached.

For example, in the "Amount" mode, you can set the amount and stop charging if the amount reaches the set value.

- (1) Duration mode: Users can set the duration and start time of charging according to their consumption habits.
- (2) Amount mode: Before setting this mode, you need to set the tariffs on the parameter "charger settings" interface, enter the predetermined amount and start charging time, and stop charging when the set amount is reached.
- (3) Energy mode: Set the energy ahead of time and the charger will stop charging after reaching the set energy.

**Note:** The function is always effective after "Everyday" is enabled.

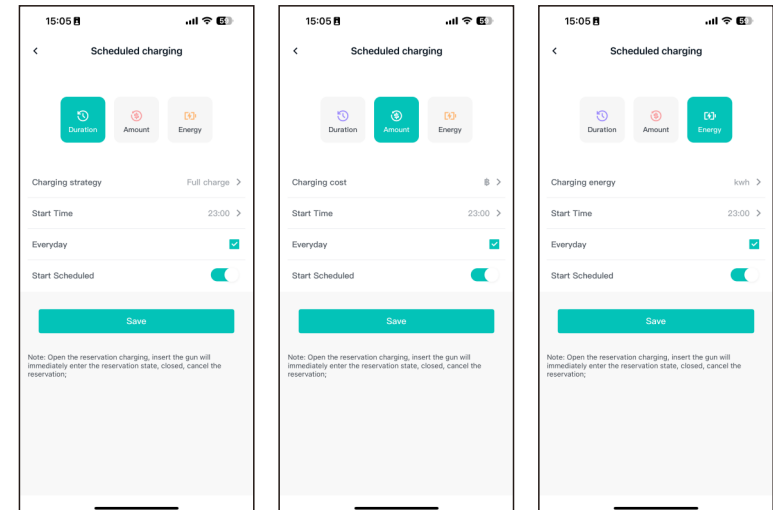

11.2.9 Charger parameter settings Basic parameter Settings and function Settings of the charger, including Basic info, Charger settings, load balancing, authorization, off-peak Regulations, charging tariffs, connect to WiFi and Firmware upgrade.



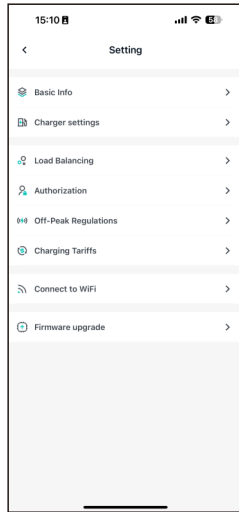

### Basic info

Charger ID: The authentication code of the charger cannot be modified.

Version : Firmware version of the charger.

Charger Name: A custom name for the charger.

Country: Set the current country so that the charger displays the correct time.

Time zone: Set the current time zone so that the charger displays the correct time.

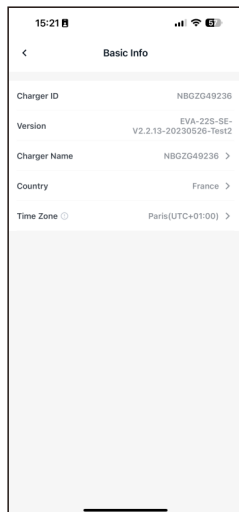

### Charger Settings

**Charging mode:** Three modes control the charging of the charger, APP, RFID and plug and charge.

**Solar Mode:** The Solar feature works in three ways, Fast, ECO and ECO+. In ECO mode, you need to set the power that can be allowed obtain from the grid.

**ECO current limit:** In solar mode, part of the charging energy comes from the photovoltaic and part from the grid. Here, set the power that is allowed to be obtained from the grid.

**Electronic lock:** Set the way to disconnect the connector after charging. You can unlock the connector manually or automatically through the APP.

**Maximum output current:** Limit the output capacity of the charger. For example, a 7kw charger with a maximum output of 32A can limit the output power by limiting the output current. Calculation mode:

Single phase charger:  $230V \times (XX)A = XX(KW)$  ,  $230V \times 32A = 7.36KW$

Three phase charger:  $230V \times (XX)A \times 3 = XX(KW)$  ,  $230V \times 32A \times 3 = 22KW$

**Low-power Reservation:** After the EV is connected to the charger, and start a pre-set charging session, the charger will output Minimum power before reaching the pre-set time.

**LCD close Enable:** For the charger with LCD screen, you can control the LCD on or off.

**Warm-up function:** After the car starts preheating function, it will not consume the electric energy of the battery, which is provided by the charger.

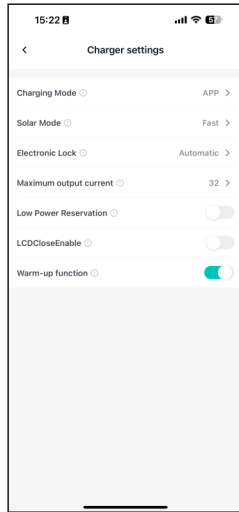

### Load balancing

Wiring sampling: The load balancing function and the solar function detect the type of tool for fuse or grid power. CT2000, CT3000 and meter.

Total domestic power(kw): Set the total capacity of the home grid to maintain a balance between load and charger to avoid overload trips. If your detection tool is a meter, you need to select the corresponding model and set the meter address( check on the meter screen).

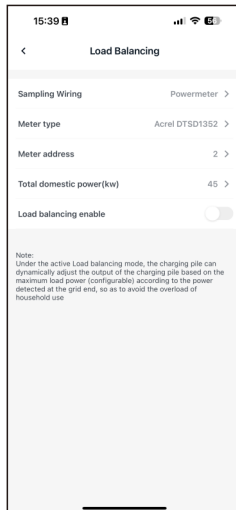
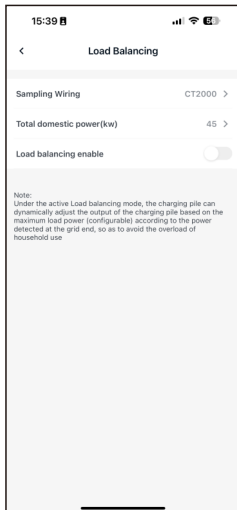

### Authrization

To manage authorized users, you can view the authorization time, account name, and delete user in the authorization management interface.

Users can authorize other users to use charging stubs through authorization management. Enter the user name to authorize other users to use the chargepoint. If the person you want to authorize does not have an account, you can register for the new user by registering the new user in the upper right corner.

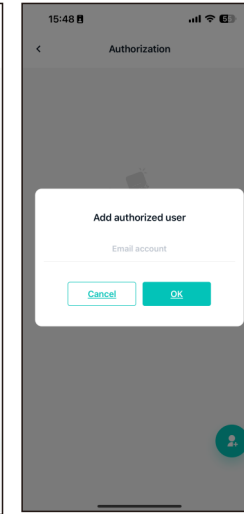
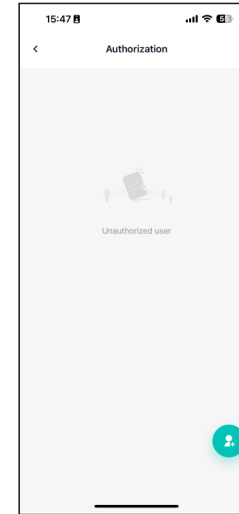

### Off-peak Regulations

According to the power price, set the output capacity of the charger in various time periods to save electricity costs. You can set a maximum of five time periods.

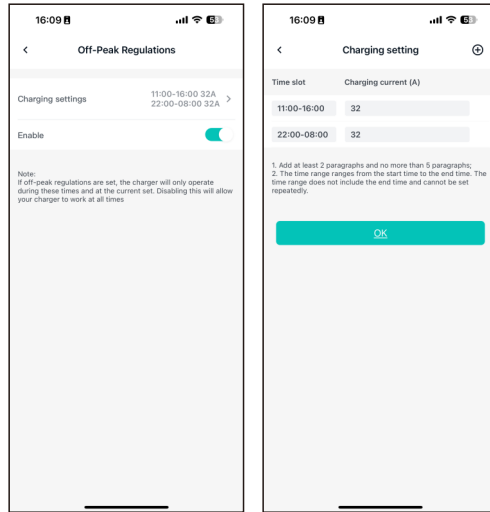

### Charging tariffs

Currency: Select the currency in which the charge is settled and the charge report displays the bill with currency.

Tariffs setting: The charge tariff is used to calculate the cost of electricity consumed. The charge report shows the total cost. You can set up tariffs for up to 5 different time periods.

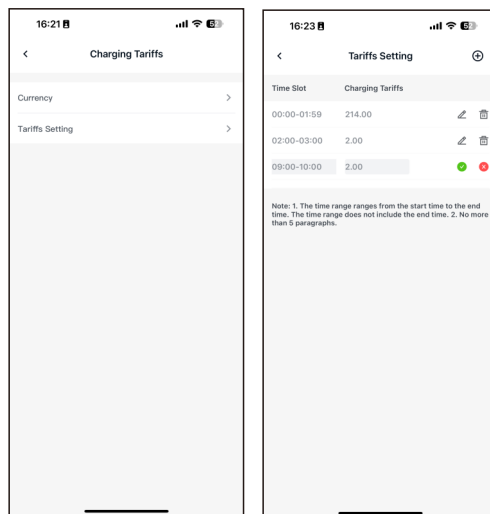

### Connect to WiFi

When the charger is not connected to the server, every 60 seconds will switch to AP mode. search for the charger WiFi, and the WiFi name is the charger ID. After connecting the charger WiFi, you can enter the setting page to set the parameters of the charger. When the charger is connected to the network, you can switch to AP mode in the parameter setting, set the charger to AP mode, and then connect. Switching to AP mode can switch the STA mode to AP mode. If it is not operated for 60s, it will switch back to STA mode and connect to the server. Click the "connect to WiFi" button to enter the hotspot connection page. When connecting WiFi at the charging point, please note the charger ID of the current stub. The connected hotspot must be the charger ID. Click the upper right corner of the hotspot connection page to view the operation instructions of the WiFi Direct connection function.

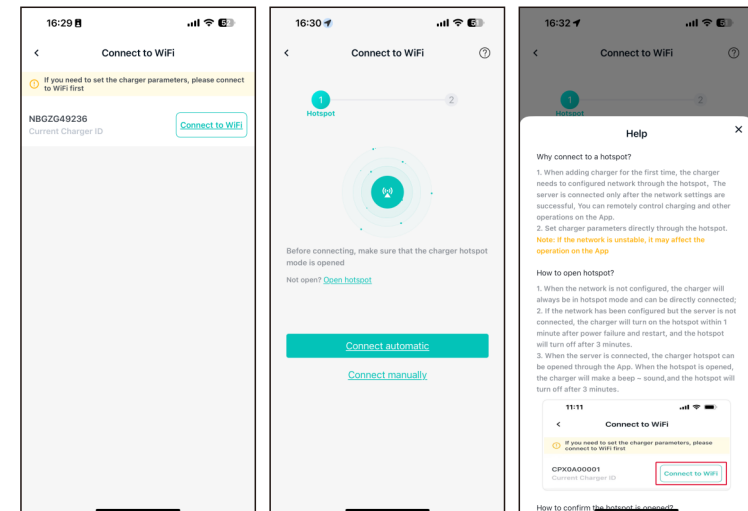

Only when the charger is in AP mode can you use the phone to connect to the charger. The charger ID is displayed in AP mode and the charger parameters can be set. Pay attention to the format restrictions of the parameters when setting the pole parameters.

- (1) IP address, gateway, mask, and DNS should be filled in according to the four-segment number format, for example: 192.168.1.1
- (2) The following parameters must be integers: heartbeat interval (5-300), PING interval (5-300), meter upload interval (5-300), maximum output current of the pole (greater than 3), protection temperature (65 -85), externally monitors the maximum input power (greater than 3).
- (3) rate range is (0-5000), you can set the decimal.

(4) The following parameters can only be numbers or letters: card reader key, WiFi password, Bluetooth password, 4G password, 4G APN, handshake login authorization key.

(5) The following parameters can only enter numbers, uppercase and lowercase letters, icon page to view the operation instructions of the WiFi Direct connection function. underscores (\_), spaces (-): WiFi name, Bluetooth name, 4G username.

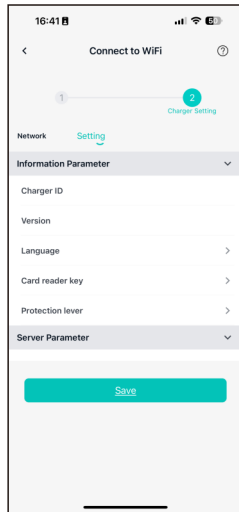

### Firmware upgrade

EV charger firmware upgrade, when there are new functions and other upgrades, users can achieve one-click upgrade through the interface.

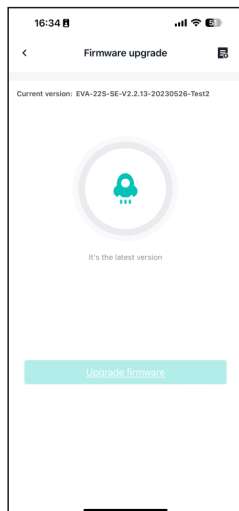

### 11.2.10 Account Management

Users can manage their accounts, set their avatars, change their passwords, and bind their mobile phone numbers and mailboxes.

Change password: You need to verify the original password, then enter and confirm the new password.

Modify the phone number: Follow the steps to verify the new phone number with a verification code.

Modify the mailbox: Follow the steps to verify the new mailbox by verification code.

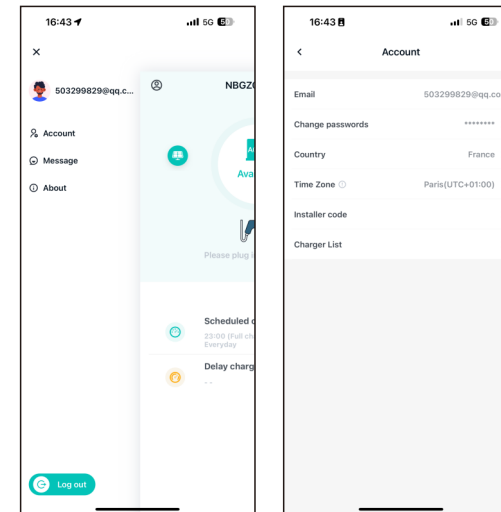

## Warranty

The warranty period of this product (Including hardware and software) is 2 years. If the contract stipulates otherwise, the contract shall prevail.

For warranty cases during the warranty period, the customer should present the invoice of the purchase of the product to our service team. At the same time, the nameplate on the product should be clearly visible, otherwise the warranty claim might not be accepted.

## Warranty condition

We will repair or replace the product free of charge during the warranty period. The defective machine after replacement shall be owned by us, and the customer shall reserve a certain amount of time for us to repair the faulty machine.

## Liability exemption

We reserve the right not to accept the warranty claim if the conditions below happen.

- 1.No trademark on the product.
- 2.Warranty period has expired.
3. Fault or damage caused by incorrect installation, by installing the device in a not allowed environment, by improper storage or usage, etc.(e.g. too high or too low temperature, moisture or too dry environment, high altitude or unstable voltage/ current etc.
- 4.Failure or damage caused by the installation repair, modification or disassembly by unauthorized service personnel.
- 5.Failure or damage caused by using our non-genuine spare parts.
- 6.Damage or damage caused by accident or human cause (operational error, scratching, handling, bumping, access to inappropriate voltage, etc.), or transport damage.
- 7.Failure or damage caused by force majeure such as natural disasters (such as earthquakes, lightning strikes, fires, etc.)
- 8.Other failures or damages that are not caused by quality problem of the product or its components.

## Statement of liability

The copyright of this manual belongs to our company. Any organization or individual may not extract or copy part or all of the contents of this manual without any written permission from us, and may not be reproduced and spread in any form (including materials and publications). We have the final right to interpret this manual. This manual is subject to change without prior notice. For more information, please contact support@atesspower.com.

## 13.1 Electrical diagram

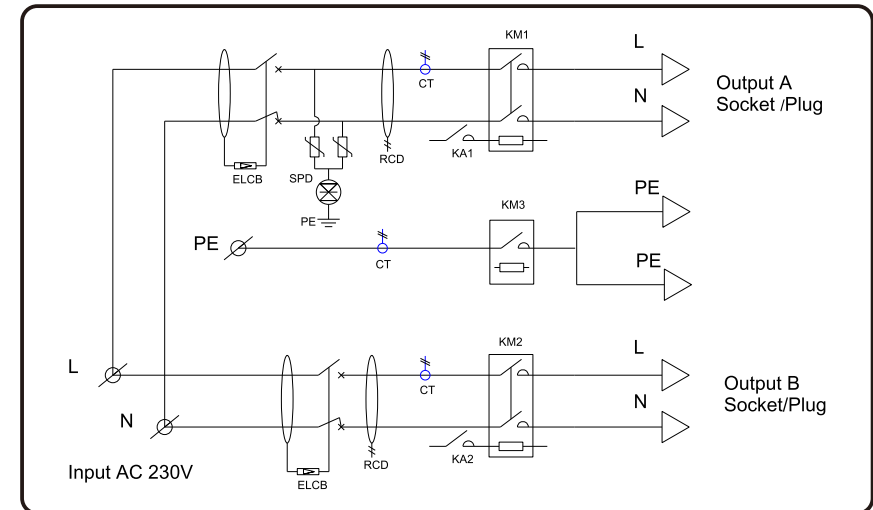

Fig11-1. Main circuit diagram

## 13.2 Contact

Shenzhen ATESS Power Technology Co.,Ltd

Address: GROWATT-ATESS Industrial Park, No.23 Zhulongtian Road, Shuitian Community, Shiyan Street, Baoan District, Shenzhen

Website: www.atesspower.com

Service line: +8675529988492

E-mail: service@atesspower.com

## 14 EU Declaration of conformity

This declaration is issued under the sole responsibility of the manufacturer Shenzhen ATESS Power Technology Co.,Ltd. This is to declare that the products listed below have been developed, constructed and manufactured according to the following EU directives:

- LVD directive 2014/35/EU& EMC directive 2014/30/EU

The applied harmonized standards are shown in the following list :

Product	Standard
NOVO EVA-07D-SE	
NOVO EVA-07D-PE	
NOVO EVA-11D-SE	EN IEC 61851-1 :2019
NOVO EVA-11D-PE	EN IEC 61851-1:2021
NOVO EVA-22D-SE	
NOVO EVA-22D-PE	