



SHENZHEN ATESS POWER TECHNOLOGY CO.,LTD

GROWATT-ATESS Industrial Park, No.23 Zhulongtian Road, Shuitian Community,
Shiyan Street, Baoan District, Shenzhen

Tel: +86 755 2998 8492

Web: www.atesspower.com

Email: info@atesspower.com

Revised date: 2025-02-24



ATESS HPS 50/100/120/150

Hybrid Power System

User Manual

Contents

1 Introduction

- 1.1 Contents
- 1.2 Target readers
- 1.3 Symbols

2 Safety Instructions

- 2.1 Notice for use
- 2.2 Important note

3 Product Description

- 3.1 Transportation
- 3.2 Inspection and storage
- 3.3 Dimension
- 3.4 Packing information

4 Transportation and Storage

- 4.1 Energy storage system
- 4.2 Circuit diagram of HPS
- 4.3 Layout of the main components
- 4.4 Function protection

5 Product Installation

- 5.1 Installation condition and requirements
- 5.2 Tools and spare parts for installation
- 5.3 Mechanical installation
- 5.4 Electrical installation
- 5.5 Communication
- 5.6 ATS wiring
- 5.7 DG dry contact connection
- 5.8 Parallel connection

6 Initial Power On

- 6.1 Inspection
- 6.2 Power supply
- 6.3 Power On steps
- 6.4 Operation completion
- 6.5 Power Off steps

7 Product Operation

- 7.1 LCD display screen introduction
- 7.2 LCD operation
- 7.3 LCD display information schedule
- 7.4 General troubleshooting
- 7.5 Working mode

8 Routine Maintenance

- 8.1 Regular maintenance
- 8.2 Waste disposal

9 Appendix

- 9.1 Specification
- 9.2 Inductive Load Conditions
- 9.3 ATESS Factory warranty
- 9.4 Maintenance and inspection checklist for running system
- 9.5 Maintenance and inspection checklist for shutdown system
- 9.6 EMS mode RS485 command

1 Introduction

1.1 Contents

This manual will provide detailed product information and installation instructions for users of the ATESS HPS50-150 hybrid power system inverter (hereinafter referred to as HPS) of Shenzhen ATESS power Technology Co., Ltd. (hereinafter referred to as ATESS).

Please read this manual carefully before use and kindly store it in a convenient place for installation, operation and maintenance. ATESS will constantly update and revise this manual without inform users by any notice or modification, and it is inevitable that there is a slight discrepancy or error between the manual and the actual product, Please refer to the actual products that you have purchased. Users should contact their local distributors or log in to ATESS Website to obtain the latest version of the manual.







1.2 Target readers

Qualification:

- Only professional electricians certified by relevant departments can install this product.
- The operator should be fully familiar with the structure and working principle of the entire energy storage system.
- The operator should be fully familiar with this manual.
- The operator should be fully familiar with the local standards of the project.

1.3 Symbols

In order to ensure the personal and property safety during installation, or optimally efficient use of this product, symbols are used highlight the information. The following symbols may be used in this manual, please read carefully, in order to make better use of this manual.

	<p>DANGER DANGER indicates a hazard with a high level of risk which, if not avoided, will result in death or serious injury.</p>
	<p>CAUTION CAUTION indicates there is potential risk, if not avoided, could result in equipment malfunction and property damage.</p>
	<p>Caution, risk of electric shock When battery bank connecting point are exposed, there will be DC voltage in the equipment DC side; and when output breaker is on, there is a potential risk of electric shock.</p>
	<p>Caution, risk of fire hazard Suitable for mounting on concrete or other non-combustible surface only.</p>
	<p>Protective conductor terminal The inverter has to be firmly grounded to ensure the safety of personnel.</p>
	<p>Risk of electric shock, Energy storage timed discharge Electrical shock danger exists in the capacitor; the cover shall be moved at least 5 minutes later after all powers are disconnected.</p>

2 Safety Instructions

2.1 Notice for use

HPS installation and service personnel must be trained and familiar with the general safety requirement when working on electrical equipment. Installer and service personnel should also be familiar with the local laws, regulations and safety requirements.

- Read this manual carefully before operation. HPS will not under warranty if any incorrect operate according to this manual.
- Only qualified electrical technician can operation HPS.
- When HPS is power on , do not touch any electrical parts except for the touch-screen.
- All electrical technician must comply with local electrical operation standards.
- Permission from the local utility department is required.

2.2 Important note

Following instructions including transportation, mounting, wiring and commissioning in this user manual are required by a proper installation.

The protection level of HPS is IP20, which is designed for indoor installation.

Please refer to chapter 5 for installation instruction.



Item 1: Static electricity can cause damage to HPS

Electrostatic discharge may cause unrecoverable damage to HPS internal components!

When operating HPS, operator must comply with anti-static protection norms!

Item 2: Restriction

HPS cannot directly use with life support and medical equipment.

Item 3: Precautions

Make sure installation tools or other unnecessary items are not left inside HPS before power on.

Item 4: Maintenance notice

Maintenance can only be carried out after HPS totally power off.

Transportation and Storage 3

3.1 Transportation

Transportation should follow the transportation methods described in the user manual. HPS weight and center of gravity should be taken into account during transportation. The center of gravity is marked on the box.



Caution, risk of danger

During transportation, lifting equipment and personnel must be qualified. HPS should be placed vertically and the inclination cannot be more than 10 degrees. It is not allowed to place HPS upside down or transport in a horizontal position. Incorrect lifting and transportation can lead to serious injury, property loss and damage to HPS.

3.2 Inspection and storage

HPS should be carefully checked before signing the document from the transportation company. Check the received items against delivery note, and if there is any defect or damage, immediately notify the transportation company. If necessary, please seek help from ATESS service team.



Caution

HPS can only be stored when it is stopped and all the doors are closed in a dry room to protect the internal circuits against dust and moisture.

3.3 Dimension

Model	HPS50	HPS100	HPS120	HPS150
Dimension (W*H*D)mm	950/1860/750	1200/1900/800		
Weight(kg)	610	948	1025	1230

Figure-Dimension and weight of HPS

3.4 Packing information

NO.	Name	Unit	Qty.	Note
1	HPS	unit	1	Key included
2	User manual	pcs	1	
3	Certificate	pcs	1	
4	Factory test report	pcs	1	

Figure-Packing information

4 Product Description

4.1 Energy Storage System

HPS is designed for energy storage system, it converts DC current generated by battery bank into AC current and feed it into the load/grid, also it can take power from solar or grid to charge battery to ensure uninterrupted power supply to the load.

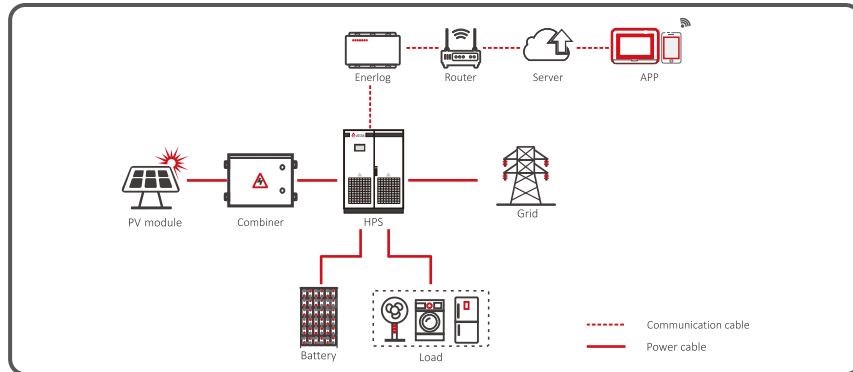

4.2 Circuit diagram of HPS

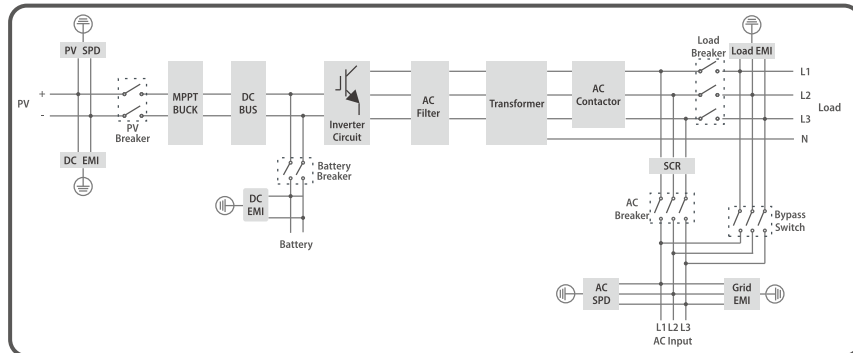

4.3 The layout of the main components

4.3.1 External components

The main external components of the HPS include: LED indicator, LCD touch screen, off-on knob, emergency stop button and other parts.

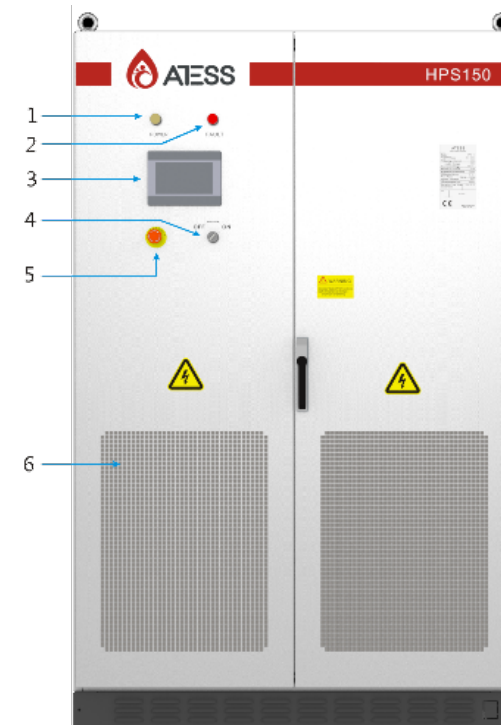

Appearance description of HPS

NO.	Name
1	Power indicator
2	FAULT
3	Touch Screen LCD
4	OFF/ON knob
5	EMERGENCY STOP
6	Dust screen

Part description

● Indicator

There are two LED indicators on HPS which is used to display the current status of HPS.



POWER



FAULT

LED	Description
POWER	When HPS power on normally
FAULT	Lights when there is failure in circuit system.

● Emergency STOP

The emergency stop button is only used in case of emergency.



Emergency STOP

The emergency stop button immediately disconnects HPS with both grid and battery to ensure the safety. HPS will lock in the "Off" position by press this button. Only release the emergency stop button by rotating it clockwise and switch off AC, DC breaker, then HPS will resume operation normally.

● Off-on knob

It is used to switch on / off HPS.



Off-On knob

Please read Section 7 "Product operation" for detailed switch on / off process.

● Touch screen

It displays HPS operating parameters, power generation, and faulty information record. Please refer to Section 7 for details.

4.3.2 Internal component

The internal components of HPS include: PV circuit breaker, battery circuit breaker, grid circuit breaker, maintenance switch, load circuit breaker, power supply micro break, AC lightning protection switch, PCB, etc.

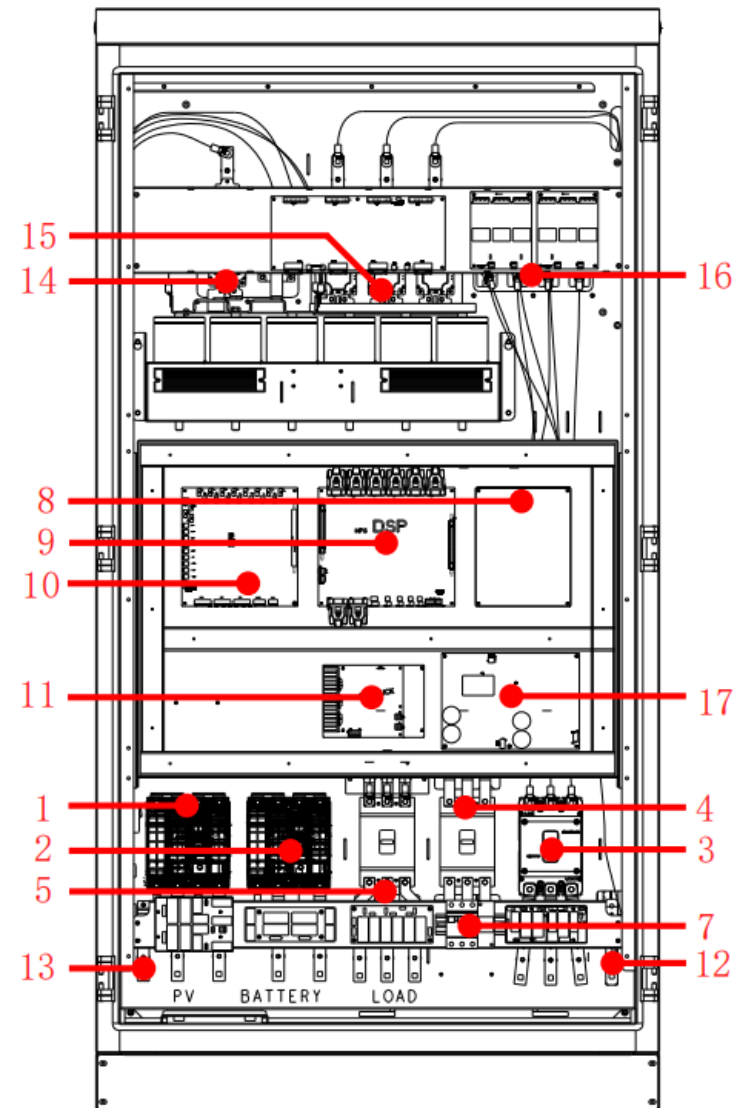

The front structural drawing of HPS50

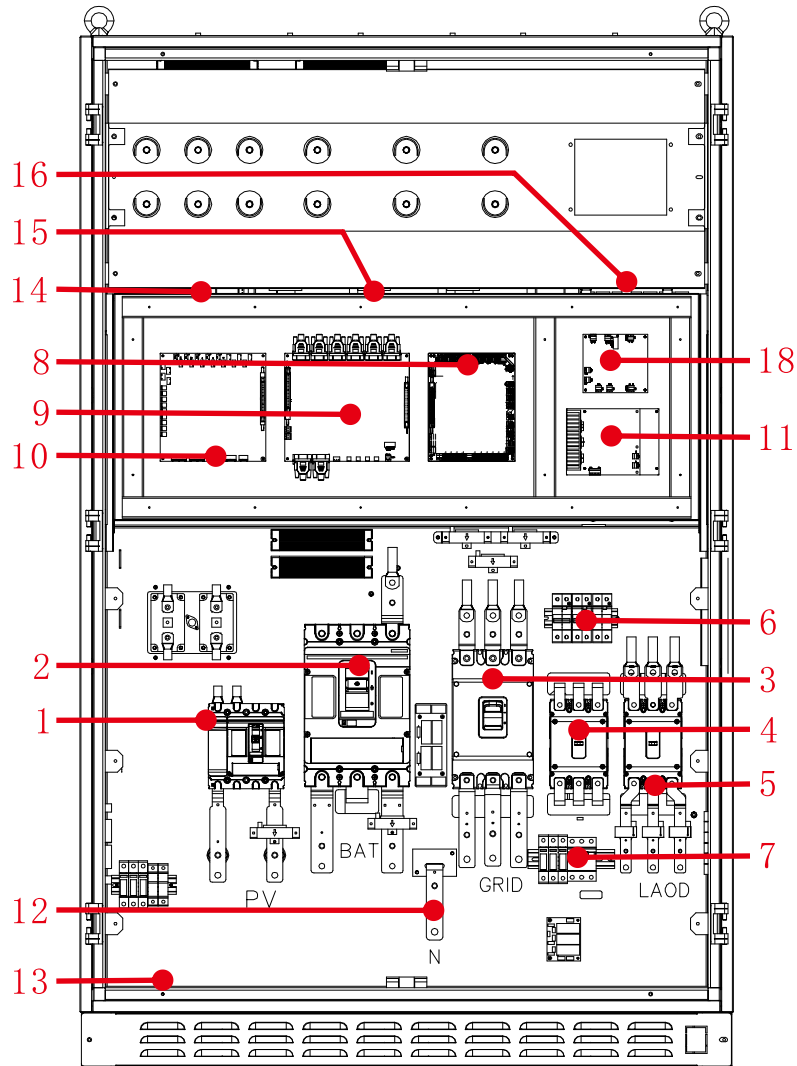

The structural layout of HPS100/120/150 is basically the same, please pay attention to the printing on machine.

NO.	Name	Description
1	PV input	Control the connection of battery and HPS
2	Battery input	Control the connection of battery and HPS
3	AC input	Control the connection of grid and HPS
4	BYPASS	Maintenance switch, see 8.1.3 for details
5	AC output	Control the connection of load and HPS
6	Power supply micro break	power board, fan power switch
7	AC lightning protection switch	Switch for AC lightning protection
8	Control board	HPS main control board, with communication interface
9	N terminals	Load and grid N terminals
10	Interface board	HPS power supply conversion PCB
11	Sampling board	voltage current temperature sampling PCB
12	BUCK board	DC power supply PCB
13	Earth terminals	Grounding terminals
14	IGBT1	BUCK IGBT
15	IGBT2	INV IGBT
16	SCR	Control on/off grid switch
17	24V power board	24V power board of the HPS
18	Rectifying board	PCB for AC power supply and AC/DC power supply converting

4.4 Function protection

Anti-islanding protection

When the utility is shut down due to fault or equipment maintenance, HPS will physically cut off the connection with grid in order to protect the operators working on the utility grid, HPS fully meets the relevant national standards.

Lightning protection

The HPS has built-in lightning protection module, with DC/AC over-voltage lightning protection, to avoid being struck by lightning.

For more protection functions, please refer to Section 7.3.

5 Products Installation

5.1 Installation condition requirements

To ensure HPS operation properly, the installation environment is required as follows:

- > The ingress protection of HPS is IP20. Moreover, as this product is an electronic equipment, it shall not be placed in humid environment;
- > Install indoors and avoid directly sunlight and rain;
- > Excellent indoor ventilation ;
- > Clean installation environment ;
- > As some noise will be produced in operation,HPS shall be installed far from residential quarters;
- > The installation ground shall be even enough, and firm enough to support the weight of HPS;
- > The installation position shall be convenient for maintenance;
- > Ambient temperature range: -25°C~55°C;
- > Appropriate space shall be reserved for HPS to ensure ventilation and cooling.

We suggest HPS is installed in the distribution room. The floor, wall clearance, ventilation equipment and precaution should be designed by professional personnel and satisfy the following requirements.

● Foundation requirement

HPS is required to install on even ground with fire-retardant material as the surface or channel steel support structure, and sag or tilt ground is prohibited. The foundation shall be solid, safe and reliable. The foundation shall be capable of bearing the load of HPS. Its load bearing ability shall be concerned throughout the installation place selection.

● Clearance space

During installation of HPS, appropriate space shall be left to the wall or other equipment, in order to satisfy the requirements on narrowest maintenance channel, emergency exit and ventilation.



800mm or more space should be left either in the front, on the back and on the top of HPS for installation, cooling and maintenance.

● Cable trench

The cable connection of HPS adopts bottom inlet and bottom outlet. Cable trenches are recommended to ensure easy installation and maintenance.

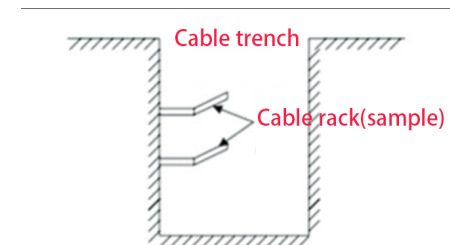

The cable trenches are often designed and constructed by the construction side based on relevant standards, with the equipment weight and dimensions required to be considered. Good electrical connection is needed between different cable trenches and GND terminals.

● Wiring specification

Communication cable should stay away from power cable. Both cables shall be kept in 90 degrees, and try to use as short as possible. It is recommended that the insulation impedance of BT + and BT - at DC end to ground to be higher than 1m Ω

The power cable and communication cable shall be placed in different cable trenches respectively to avoid lengthy routing between the power cable and other cables, to reduce the electromagnetic interruption caused by sudden change of the output voltage. The distance among the power cable and communication cable shall be more than 0.2m. When the cables are crossed, the cross angle shall be 90 degrees, while the distance can be reduced appropriately.

● **Ventilation requirement**

HPS will produce lots of heat during operation. When ambient temperature is too high, the electrical property of HPS may be affected, or even be damaged. Therefore, the heat release shall be fully considered when designing the power distribution room to ensure HPS operations in high efficiency.

● **Ventilation environment**

To satisfy the ventilation requirement of HPS, considered when installation environment shall meet the following conditions:

※ HPS shall be prevented from being installed in the place of poor ventilation condition and insufficient air flow;

※ The air inlet shall have enough air supplementation.

● **Ventilation equipment**

To ensure safe and reliable operation of the HPS, the ambient temperature must be within the permission range -25°C~ 55°C, therefore, appropriate ventilation devices must be equipped with to release the heat generated by the HPS.

1. Must inside ventilation equipment inside the distribution room to ensure release of the heat generated by the HPS to remain in allow ambient environment temperatures.
2. Additional fan can be added at the air duct outlet to exhaust the air out and ensure balanced pressure;
3. The direction of the air outlet shall be selected according to the local actual wind direction;
4. Pay attention to the dustproof measures and waterproof design at the air inlet and outlet;
5. If more air ducts are required, its dimensions shall be designed by the professionals according to the air output amount.

● **Other protections**

With IP20 of protection level, HPS is appropriate to be installed in dry and clean environment. Meanwhile, water leakage of the property shall be prevented, as it may damage HPS. According to EMC requirement and noise level, HPS shall be installed in industrial environment.

5.2 Tools and spare parts for installation

Tools and spare parts required for installation as follows:

- Hoisting crane, forklift or fork lift truck (with the capacity for bearing the weight of HPS)
- Torque wrench
- Screwdriver
- Wire stripper
- Terminal crimping machine
- Heat dryer
- Megger and multimeter

5.3 Mechanical installation

5.3.1 Transportation of packaged whole machine

HPS is transported as an integrated unit, it can be hoisted from the bottom with a forklift, or move it with a hoisting crane or crane.

Note 1: HPS is integrated and cannot be dissembled either in transportation or installation. Any fault attributed to modification unauthorized by ATESS is beyond the warranty.

Note 2: In movement, tilt, violent shake or sudden force upon HPS shall be prevented, such as sudden down of lifting.

Note 3: Please read carefully the labeled parameters to select an appropriate transportation means and storage place.

It is strongly recommend that use forklift to move HPS if possible



We suggest to lay the DC input cable and AC main cable before HPS move to designated place. As these cables are relatively thick, they are hard to be cabled after HPS is installed.

To keep HPS in a better protective status, please adopt transportation with package as much as possible, and comply with the labels printed on the package in transportation:

Sign	Indication
	The gravity centre
	Lifting logo
	Face up to prohibit the inverter horizontally, tilted or upside down
	Handle with care, to avoid the transport environment too intense collision friction damage to the inverter
	Keep away from moisture

Fully packaged HPS can be moved with forklift, hoisting crane or crane. Notice with weight sign painted on the package to ensure all transportation devices with enough load capacity before moving. As the gravity center of the equipment locates at the lower place symmetrical in front and back, left, right, the support point or hoisting point shall be arranged reasonably in transportation.

The forklift transportation is the standard one. The gravity center of the cabinet in transportation should locate between two forks of the forklift. The large size HPS may block driver's sight, and it shall be treated with cooperation of the aid personnel.

5.3.2 Transportation of unpackaged HPS

● Demolish the package of HPS

Please demolish the packaged HPS according to the following procedures:

Procedure 1: Demolish the wood side and roof of the packaged cabinet

Procedure 2: Demolish the out-set package material on the HPS

Procedure 3: Demolish the fastening screws between the HPS and the pallet

- ① Demolish the front and back cover lids of the pedestal;
- ② Screw off the hold-down nuts at the bottom of the wood pallet;
- ③ Remove the screws, and HPS will depart from the wood pallet.

● Movement and installation of unpackaged HPS

HPS with demolished package can be moved with forklift, hoisting crane, slide rail or crane. If the package demolished place is far from the final installation place, it can be transported with forklift containing wood pallet.

After remove the wooden pallet at the bottom of HPS, when using the forklift, the front and rear cover plates of the base need to be removed first, and the center of gravity should be placed in the middle of the two forklifts, and then start lifting and transporting, as shown in the following figure:



Caution, risk of danger

Transporting HPS with forklift slowly and gently to avoid violent vibration of HPS or collision with other objects.

If lifting method is used for moving, please pay attention to the lifting position, ensure that the lifting angle is 70°, and be cautious of the center of gravity position of the inverter.

NOTE:

- It is necessary to always pay attention to the position of the center of gravity of inverter.
- Take necessary auxiliary measures to ensure the safety of transportation personnel.
- Take necessary auxiliary measures to ensure that the HPS is delivered to the final installation site.

5.4 Electrical installation

5.4.1 Input and output requirements



Caution, risk of danger

- There is a danger of high voltage electrical shock during operation HPS, only qualified professional electricians are allowed to operation.
- All connections with HPS shall be done under non-voltage state.
- HPS may be damaged if input or output terminal is incorrectly plugged.
- Failure of acting upon this information may cause serious personnel injury or significant property loss even to death.

● Battery

The battery operating voltage is 352V-600V. The battery voltage should be not lower than 352V and not higher than 600V.

● PV module

The MPPT voltage range is 480V - 800V, which means the maximum MPPT working voltage should not higher than 800V, and minimum should not lower than 480V.

The maximum PV module open circuit voltage should not higher than 1000V, otherwise it will trigger HPS over-voltage protection and shut down.

● PV and battery configuration

In order to fully charge battery by PV power, the MPPT voltage must be higher than the maximum battery voltage. The appropriate and recommend configuration is the MPPT voltage should be 50-200V higher than the maximum battery voltage, otherwise a large difference will cause HPS accelerate the wearing and reduce efficiency.

● Three phase grid connection

The three phase utility connection and HPS installation should follow local utility connection requirements regulations and approved by local relative department. HPS will constantly detects whether the utility meets connection conditions and its protection parameters can be set.

Model	50/100/120/150
Grid voltage range	360V-440V
Grid frequency range	45Hz-55Hz/55Hz-65Hz

● Cable requirements

1. Please select the corresponding withstand voltage cable according to the voltage level.
2. Because different voltage will lead to change of current, please calculate the corresponding cable diameter according to the actual voltage range. The following table only provides the cable requirements of the lowest working voltage and rated power. It better to calculate it according to the site voltage in actual application, because different voltage will lead to current change. please inquire the ATESS service team if you need more details.

Cable Model	Cable Diameter Requirements (mm ²)				Aperture	
	HPS50	HPS100	HPS120	HPS150	HPS50	HPS100/120/150
	Bellow are total line diameter					
PV	50mm ²	70mm ²	95mm ²	120mm ²	Φ8	Φ10
Battery	50mm ²	120mm ²	120mm ²	150mm ²	Φ8	Φ10
Utility	70mm ²	120mm ²	120mm ²	150mm ²	Φ8	Φ10
Load	35mm ²	70mm ²	70mm ²	95mm ²	Φ8	Φ10
N wire	70mm ²	120mm ²	120mm ²	150mm ²	Φ8	Φ10
Earth wire	More than 16 mm ² . Green and Yellow cable is recommended				Φ8	Φ8
Communication Wire	0.75mm ² , shielded communication line is recommended				/	

5.4.2 DC cables connection



Caution, risk of danger

The positive and negative of the battery shall not be connected in reverse. A multimeter shall be used to determine the polarity before connect into the corresponding input ends of the battery.

Specific procedures are as follows:

- 1) Disconnect the distribution circuit breaker at the DC side, and ensure that no voltage on the wire at DC side.
- 2) Use a multimeter to measure the open circuit voltage of the battery to ensure that it is in the allowed range.
- 3) Determine the positive and negative pole of the battery with a multimeter.
- 4) Strip off the insulation skin at the end of the cable.
- 5) Crimp the wiring copper nose.
 1. Put the stripped copper core into the crimping hole of the copper nose.
 2. Use the terminal pressing machine to press the copper nose tightly. The number of crimping shall be more than two.
 - 6) Install the shrink fit sleeve.
 1. Select the heat shrinkable sleeve which is more consistent with the cable size, length is about 5cm.
 2. The heat shrinkable sleeve shall be sleeved on the copper nose of the wiring to completely cover the wire pressing hole of the copper nose.
 3. Use a heat blower to tighten the heat shrink sleeve.
 - 7) Connect the positive of the battery to the "Battery-input +" of DC input
 1. Select the bolts that match the copper nose.
 2. Connect the copper nose at both ends of the wiring firmly to the "battery input +" end of HPS and the positive pole of the battery.
 3. Tighten the bolts with a screwdriver or wrench.
 - 8) Connect the "battery input -" end of HPS to the negative pole of the battery by cable according to the method of step 7.
 - 9) Cable the "PV input +" end of HPS to the positive pole of the PV module according to step 7.
 - 10) Cable the "PV input -" end of HPS to the negative pole of the PV module according to step 7.
 - 11) Please be sure that all wirings are fastened.

5.4.3 AC cables connection



Caution, risk of danger

When connecting the utility, disconnect AC circuit breakers and ensure there are non-voltage on AC cables.

The AC output voltage of HPS is 400V, which is connected to the utility through an isolation transformer. The wiring method of AC side and grid side is as follows:

- 1) Disconnect all AC circuit breakers and ensure there are non-voltage on AC cables with a multimeter.
- 2) Ensure the wiring phase sequence at AC side is consistent with the at grid side.
- 3) Strip the insulation skin off at the end of the cable
- 4) Crimping copper nose
 1. Put the exposed copper core of the stripped wire head into the crimping hole of the copper nose.
 2. Use the terminal crimper to compress the copper nose of the wiring, and the number of crimping shall be more than two.
 - 5) Install the shrink fit sleeve.
 1. Select the heat shrinkable sleeve which is more consistent with the cable size, length is about 5cm.
 2. The heat shrinkable sleeve shall be sleeved on the copper nose of the wiring to completely cover the wire pressing hole of the copper nose.
 3. Use a heat blower to tighten the heat shrink sleeve.
 - 6) Connect "L1" cable to "L1" of AC distribution cabinet, i.e. phase a (U). Select the bolts that match the copper nose.
 - 7) Connect "L2" of AC output to "L2" of AC distribution cabinet, i.e. phase B (V); connect "L3" of AC output to "L3" of AC distribution cabinet, i.e. phase C (W); connect n-line to n wire on the inverter.

HPS must be earthing well for safety; Please make sure of the connection between PE in power distribution cabinet and PE copper in the HPS; and the earthing cable more than half of load cable, and earthing resistance is not higher than 0.1Ω.

After all the wiring completely through under the bottom of HPS, the connection port must be sealed with dust cotton, to prevent dust from entering the inside of HPS.



Connect several connecting wires on the PE copper bar as some parts inside the HPS need to be grounded, please do not change them without permission, so as to avoid electric shock

5.5 Communication

The HPS adopts various communication modes. The figure below is the diagram of the communication port of the control board.

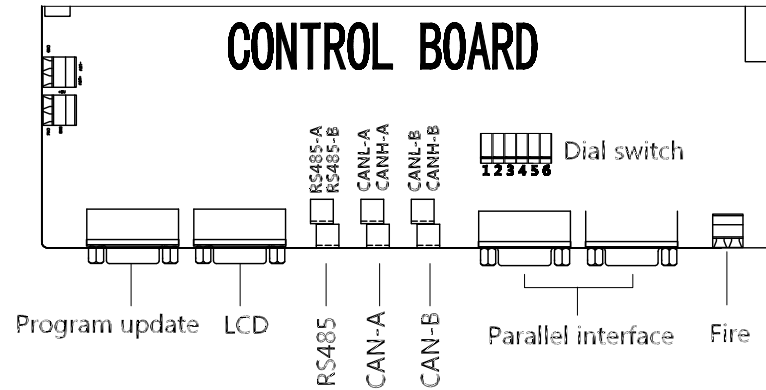

Description of dial switch:

The dial switch is a connection control switch with communication matching resistance (120 Ω). "On" indicates connection resistance and "off" indicates no connection with the resistance.

NO.	Name	Description
1	485	485 matching resistance
2	CANA	CAN matching resistance
3	CANB	CAN matching resistance
4	M-S	Parallel matching resistance
5	ON-OFF	
6	MMS	

1. RS485 communication

- Each HPS communication with others through RS485 line, communicate with other through RS485 line, and finally transmitted to the monitoring server through the Enerlog via Ethernet, which can remotely monitor the operation status and data of single / multiple HPS(s) in real time. Both ends of the RS485 communication line are connected with terminals, and the terminals at both ends are connected in parallel. The length of the line shall not exceed 1000m. It is recommended to use a special shielded communication line.
- The RS485 interface of HPS is located on the internal control board of the machine. Please distinguish "A" and "B". The wrong connection will lead to communication failure.
- If Shinemaster / Enerlog is not used for monitoring, the user's own monitoring equipment needs to be compatible with the RS485 communication ATESS RS485 Modbus protocol.
- For the same 485 bus, only 120Ω matching resistance needs to be connected from end to end. Please set the dial switch according to the field installation.

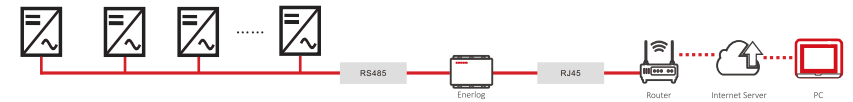

2. BMS-CAN communication

- When the HPS works with battery with BMS, it needs to communicate with BMS through CAN communication. The CAN communication interface of BMS is connected to CAN-A interface of the HPS, communication can be realized after docking the communication protocol.
- Terminals are used at both ends of the CAN communication line. The terminals at both ends are connected in parallel to make the can communication line. It is recommended to use a special shielded communication line to reduce communication interference and improve the operation stability of the system.
- The CAN-A interface is on the internal control board of HPS. Please distinguish between "L" and "H". Incorrect connection will lead to communication failure.
- If the user does not use the BMS battery system produced by ATESS, the user's own BMS battery system needs to be compatible with the BMS communication protocol of ATESS.
- For the same CAN bus, just connect 120Ω matching resistance from end to end. Please set the dial switch according to the field installation.

3. ATS- CAN communication

- When the inverter is used with ATS, They need to communicate with each other, and the CAN communication interface of the ATS is connected to the HPS CAN- B interface. Note: only the ATS produced by ATESS can communicate with the HPS.
- The ATS produced by ATESS is equipped with a special communication line for communication with the HPS.
- The CAN-B interface of the HPS is on the internal control board of the inverter. Please distinguish between "L" and "H".
- When the inverter is used with the bypass cabinet, it needs to communicate with the bypass cabinet, and the CAN communication interface of the bypass cabinet is connected to the inverter's CAN- B interface. Note: only the bypass cabinet produced by ATESS can communicate with the HPS.
- The bypass cabinet produced by ATESS is equipped with a special communication line for communication with the inverter, which can be directly connected to the CAN-B interface of the inverter.
- The CAN-A interface of the inverter is located on the internal control board of the inverter. Please distinguish between "L" and "H". Incorrect connection will lead to communication failure.
- For the same CAN bus, just connect 120Ω matching resistance from end to end. Please set the dial switch according to the field installation.

3. Parallel communication (special for customized parallel function)

- Parallel communication is required when two same models of HPS are used in parallel.
- DB9 communication line is used for parallel communication, which goes with the shipment in parallel scheme, also there will be special parallel communication interface.
- When paralleling two HPS models, DB9 communication line is used to connect the parallel interfaces of two models. Select either one reserved parallel interfaces on the control board can be selected as the reserved interface.



As Parallel function is a special customized function, please active it under the guidance of ATESS staff.

5.6 ATS wiring

1. When the system needs to be connected to utility grid and generator at the same time, ATS as an accessory of HPS is used together with HPS to switch between utility and generator.
2. The main wirings between ATS and HPS are ATS internal panel power line, CAN communication line and AC power line.

Wiring diagram is shown as below:

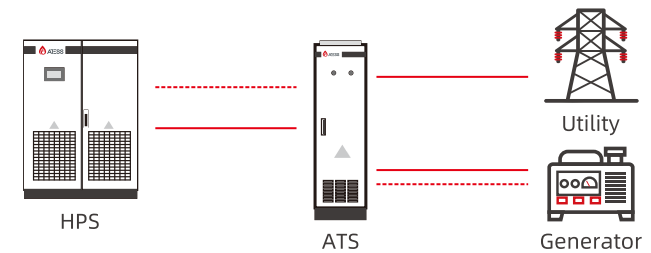

3. There are three circuit breakers in ATS. The middle circuit breaker is connected to the grid switch (AC input) of HPS. The other two are grid switch (grid) and generator (Gen) switch. Follow the sign on cabinet. HPS cannot operate properly, if either any connection incorrectly, or three phase sequence.

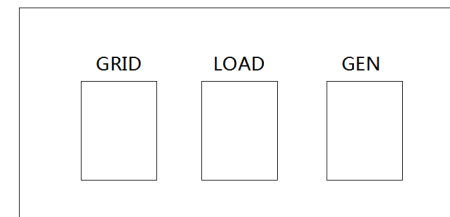

4. ATS communications with HPS by connection on CAN-B of HPS. Pay attention to the sequence and distinguish "L" and "H".
5. ATS needs to be powered by HPS and connected to CN3 of the BUCK board of HPS. Pay attention to positive and negative, red is positive and black is negative.

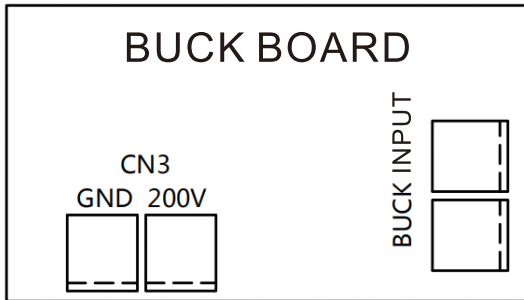

When the ATS of other manufacturers are applied CAN communication mode cannot be used to distinguish the generator and utility. They can be distinguished by connecting passive dry contact signal (it is suggested that the switchover time for ATS to switch between generator and grid should be more than 5 seconds to ensure the correct mode switching of the inverter). Connect the signal line to the CN14 port of the energy storage inverter's interface board. It's default that switch on signal means connecting the utility, and switch off signal means connecting to generator.

5.7 Diesel generator dry contact wiring

The HPS has a passive dry contact contactor to control the diesel generator, and the following is the dry contact structure diagram (initial state).

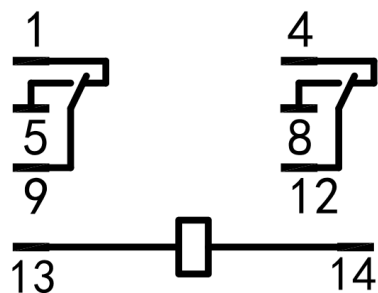

Wiring instructions:

- "13" and "14" are the power supply of dry contact contactor, no wiring required.
- There are two groups of connection contacts in the dry contact, "1", "5" and "9" are a group, "4", "8" and "12" are a group, and the two groups will act at the same time.
- The initial state is that when the inverter does not send the command to start the diesel generator, the state between "1" and "9" means stay closed, and the state between "5" and "9" means stay opened. When the inverter sends the command to start the diesel generator, "1" and "9" are switched to stay opened from stayed closed, and "5" and "9" are switched to stay opened from stayed closed. "4", "8" and "12" are the same.
- When the current needs to pass through the dry contact, the AC voltage shall not exceed 240V, the DC voltage shall not exceed 28V, and the current shall not exceed 5A.

5.8 Parallel wiring

● Parallel operation system:

- Multiple same model HPS will run same working mode and supply load simultaneously during parallelling.
- Parallel operation means in off-grid mode, multiple HPS maintain the same AC frequency, amplitude and phase.

● System requirements:

- It must be the same HPS model.
- The program has to be customized parallel program, default single model running programs is not applicable in parallel.
- The maximum parallel is 4 units during any Off-Grid scenario.

● System wiring diagram shown as follow:

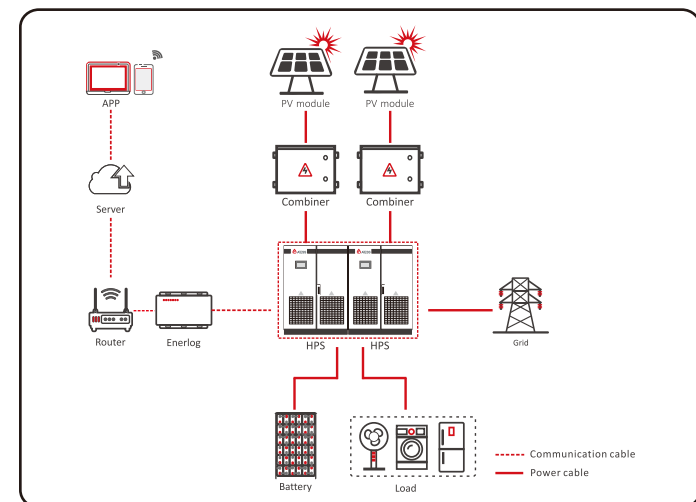

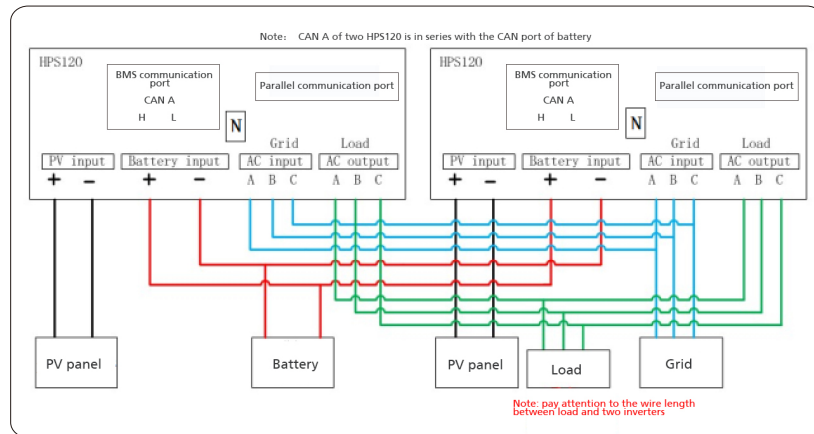

● Wiring instructions:

1. Configuration PV for each HPS as same as possible.
2. It is recommended to share the battery in order to reduce the circulation loss.
3. Each HPS needs to communicate with BMS when works with lithium battery.
4. When multiple HPS parallel, connect all of load terminals before connect to load. The cable length from load terminals to combine point must be the same.
5. In order to ensure the communication quality, please install the paralleled HPS at the same location to reduce the communication distance. length of communication cable is 10 meters, the parallel distance should be within 3 meters.

● Working mode:

The working mode of parallel system is the same as single system, but the working mode of each HPS should be set to the same.

Redundant function selection Description: Redundancy can only be selected when one HPS fails and others still enough to supply all loads; otherwise, it will cause overload fault.

Note: parallel operation is a special function. Standard HPS may not be equipped with this function. If you need this function, please contact ATESS in advance.



Please contact the ATESS service team to assist in installation to ensure the correct operation of the parallel system.

6.1 Inspection

There should be an installation inspection before HPS operation. At least two personnel do the inspection according to the items listed below to ensure the correctness of the installation.

Inspection items for installation

- There is no deformation or damage to the HPS.
- Bottom of the HPS is fixed securely, the foundation support is stable and reliable.
- There is enough space around the HPS.
- The temperature, humidity and ventilation conditions of the environment where the HPS is located meet the requirements.
- There is enough cooling air for ventilation.
- Cabinet sealing protection is complete and reliable.

Electrical inspection

- HPS is grounded completely and firmly.
- The grid voltage matches the rated output voltage of the HPS.
- The phase sequence of grid connection is correct, and the tightening torque meets the requirements.
- The positive and negative poles of DC input connection are correct, and the tightening torque meets the requirements.
- Communication wiring shall be correct and keep a certain distance from other cables.
- Cable number is marked correctly and clearly.
- The insulation protection cover is complete and reliable, and the danger warning label is clear and firm.

Other inspection

- All useless conductive parts shall be tied with insulating ties.
- There are no tools, parts, conductive dust or other foreign matters left inside the cabinet.
- There is no condensation of moisture or ice in the cabinet.

6.2 Power supply

HPS adopts the integrated AC and DC power supply method, and LCD can be ON when there is only AC or only DC.

● Battery power supply

The battery can be used for initial power on. When the battery breaker is connected, the LCD should be on.

● AC power supply

AC power supply can be used for initial power on. Connect AC input switch, bypass switch, AC output switch and the micro breaks, LCD should be on. When HPS is powered by AC, as long as the battery voltage is detected to be abnormal for more than 10 minutes, all circuit breakers except bypass will be disconnected, and HPS won't be able to start and operate when powered by AC source alone. After LCD is lighted by AC power supply, the bypass switch must be disconnected before the HPS turns on.

It is recommended to use batteries to light up the screen. After power on, do not switch the power-on knob immediately. Please check the historical information page and check whether the operation setting is in line with the actual situation. Please refer to Chapter 7 for details.

6.3 Power On steps

HPS is ready to operation after proper installation and inspected system settings.

First run

The first operation steps are as follows:

1. Connect the PV, battery, AC input and power supply micro breaks, and do not connect the AC output switch before system operates normally to avoid any impact on the load;
2. Bypass switch shall be disconnected when HPS operation normally;
3. Check whether the screen sampling data is abnormal and consistent with the actual situation;
4. Check whether the battery parameter setting is consistent with the actual battery, if not please modify.
5. If the battery has BMS, check whether the BMS is enabled and normal.
6. If the grid input end is connected to generator, check whether generator is enabled.
7. If it is equipped with ATS manufactured by ATESS, check whether the bypass cabinet is enabled.
8. Check the history information page of the screen, and check whether there are serious faults according to the general faults in Chapter 8.3.
9. After checking, turn the knob to "on", click "on" on the LCD "on / off" page, and wait for the machine to enter "grid connection"; if the site is off grid, it will enter "off grid mode" after starting;
10. During operation, observe whether the data displayed on the screen is normal and whether there is fault information reported, and whether the machine has abnormal noise and smell; if any abnormal situation occurs, please stop the machine immediately for inspection.



Warning!

The bypass switch is only used for maintenance. Please do not turn it on during normal operation.

Manual shutdown

1. After clicking the LCD shutdown button to shut down the machine manually, it must be turned on manually through the start button (on) on the LCD; if the machine is turned off by turning the knob to "off", turn the HPS knob to "on" first, and then click the "on" button on the LCD "switch on" page to start the machine, otherwise inverter cannot start automatically.
2. The inverter is still electrified after manual shutdown.

6.4 Operation completion

The following procedures shall be carried out after the inverter is normally in operation.

Procedure 1: Inspect whether abnormality exists in the inverter, such as excessive noise, excessive heat, abnormal smell or smoke.

Procedure 2: Measure whether inverter voltage, current and THD are stable.

Procedure 3: Operate LCD control panel and inspect whether it displays normally and accurately.

Procedure 4: Test whether it conforms to the preset operation logic.

By now, the pilot operation of inverter is fully completed, and we can enter the daily operational maintenance.

6.5 Power Off steps



CAUTION!

After the inverter is completely powered off, the general DC switch at battery side and the Grid switch at grid side still maintain voltage. If operations are needed, please be sure to cut off the outer power completely, and wait for not less than 5 minutes.

1. Click the OFF button on LCD or turn the off-on knob from ON to OFF;
2. Cut off DC SWITCH PV input and Battery input;
3. Cut off AC SWITCH AC input and AC output;



CAUTION!

It is normal for the inverter to give alarm during power off. The power down steps can be continued.

7 Product Operation

7.1 LCD display screen introduction

User can view the information of the HPS operation on the LCD touch screen, as well as setting the operating parameters. In order to facilitate the operation, a menu is provided below.

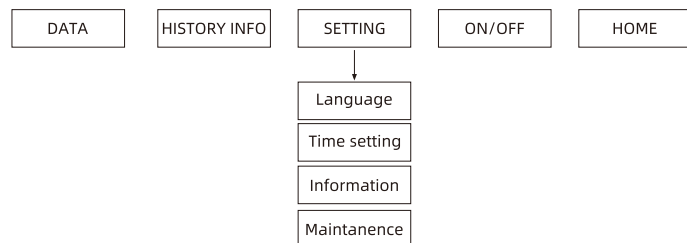

HPS LCD Menu logical structure

1. After the LCD is powered on, it enters the startup interface and home page for after 15s, but it still takes about 2 minutes to initialize. HPS cannot be started until the initialization is completed.
2. At the top right of each page, The communication status between LCD and HPS control board (if √, the communication is normal, otherwise ×, communication failure), station number of the communication end where HPS is located, system time, etc are displayed.
3. After power on and entering the home page, the program needs to be initialized for a period of time. When √ and numbers appear, the initialization is completed.

7.2 LCD operation

7.2.1 Home page

When powered or clicking “Home” button in any interface will enter into the Home page. The operating status of the inverter output power, safety standard, model, input and output voltage,current information can be viewed in the page. Pressing the following key can switch to other pages.

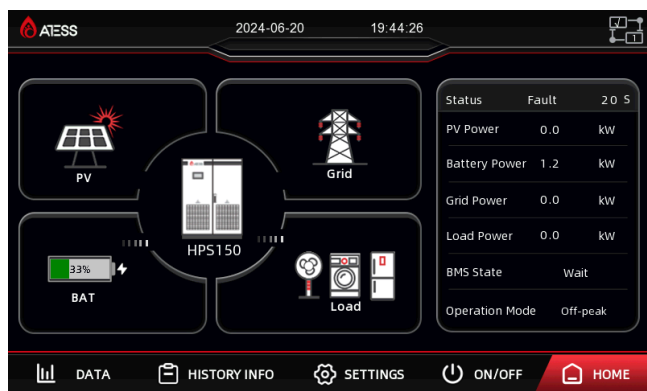

Operation status	Description
Fault	Not started or failed to start
Wait	Start initialization
Check	System self checking
Permanent fault	Serious failure occurred
Off grid mode	Off grid mode with load
On grid mode	Successfully connected to grid
PV charge	PV only charging mode
Parallel to off-grid	Parallel system waiting to enter off-grid mode
Parallel to on-grid	Parallel system waiting to enter on-grid mode

Communication station number: the number represents the current station number, which is 485 communication station number. The "√" above the number indicates that the LCD and the control board communicate normally, and when the display is "x", it indicates that the communication is lost.

On-Grid mode: when the operation state of HPS is on-grid, the current On-Grid mode will be displayed: load priority, battery priority, economic mode, EMS mode and diesel generator mode.

BMS status: when it works with lithium battery with BMS, the current BMS status is displayed here. "Wait" is displayed when there is no BMS communication.

7.2.2 ON/OFF interface

Clicking “ON/OFF” button in any interface will enter into this interface. There are “ON” and “OFF” button which is used to turn on and turn off HPS. Turn on: turn the start knob to on and click "on" to start up successfully. Turn off: shut down by clicking "off", or turn the start / stop knob to off directly. If HPS will be turned off for a long time, use the off-on knob to shut it down.

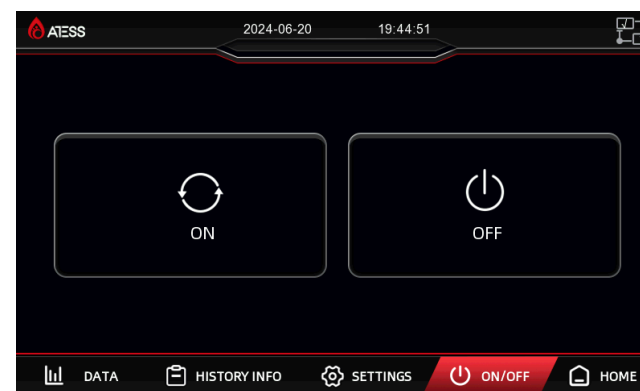

Operation data: display the current parameters and real-time data of energy storage power generation, including grid voltage, grid frequency, grid current, DC input voltage, DC input current, temperature in the case and total generation time (real-time update).

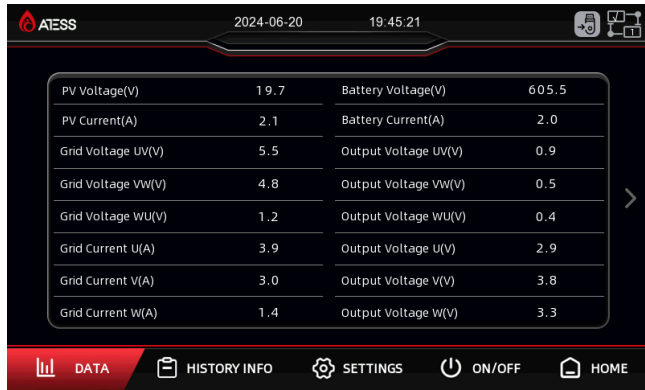

Product Information: This page shows the manufacturer, HPS serial number, hardware and software version information, and the date of manufacturing.

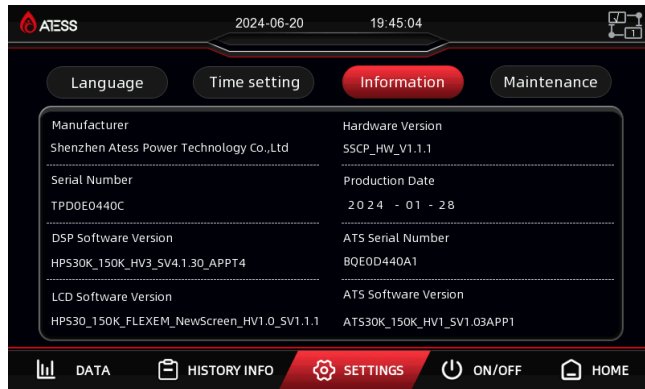

Maintenance: the interface requires a password to login. It is for electrician and maintenance personnel who are fully familiar with the structure and working principle of the DC grid system only, in order to avoid damage to personal safety and the HPS.

Enter the correct password to enter the submenu of "equipment maintenance". The submenu includes: protection parameters, calibration parameters, power grid management, factory settings. The default one is "protection parameters".

Parameter modification method: modify the set value. Click Save to change the current value to the same value as the set value. There are several reasons why the current value cannot be changed to the set value:

- LCD response is slow, you can switch pages to speed up the update.
- The value exceeds the limit and cannot be saved.

7.2.3 System setting

Clicking "Setting" button in any interface will enter into this interface.

Submenu: language, time settings, information, maintenance. Pressing the left button can enter into the corresponding submenu interface. The default one is language setting interface.

Language Settings: Select language, currently it only supports Chinese, English.



Time setting: system time setting (if the date and time displayed on LCD is not inconsistent with the actual date and time, they can be modified here).

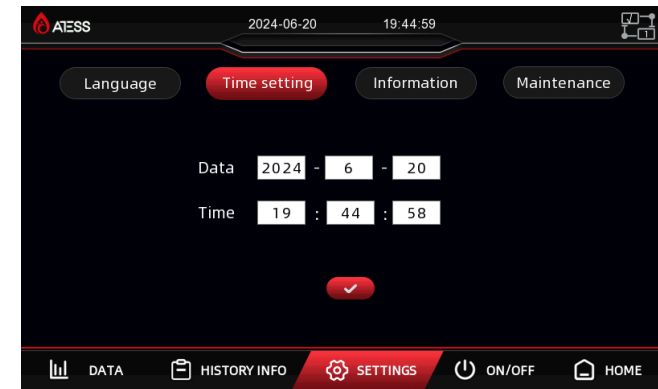

1. Maintenance:

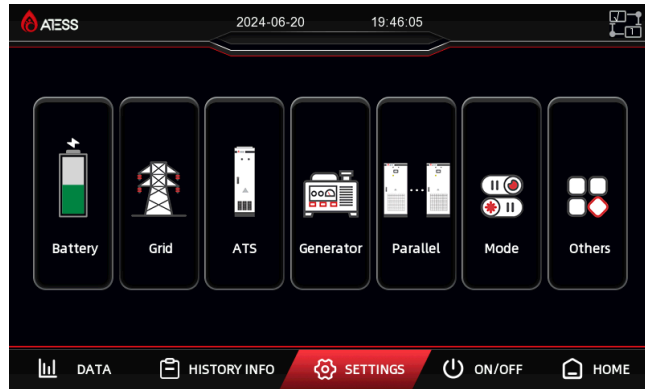

Battery: battery's setting and parameter

Grid: grid's setting and parameter

ATS: ATS's setting

Generator: GEN's setting and parameter

Parallel: HPS parallel's setting

Mode: working modes

Others: Other setting and parameter

Battery

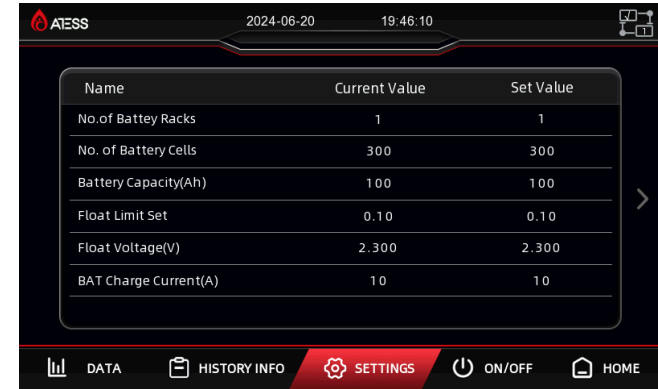

This page is the battery parameter setting page. As battery is an important part of the energy storage system, the battery parameters need to be carefully confirmed whether they are consistent with the actual situation.

No. of Battery Racks: Number of Battery Racks

No. of Battery Cells: Number of Battery Cells

Battery Capacity(Ah): Battery Capacity

Float Limit Set: When the battery with BMS, the charging current setting value will be based on the smaller one of the maximum charging current limit value sent by the BMS and the charging current setting value set on the screen. The battery real-time cell voltage will be calculated based on the maximum cell voltage sent by the BMS. When the battery without BMS, it will be floating limit in the DG mode and sends a signal to shut-off DG.

$$\text{Target charging current} = \frac{\text{floating cell voltage} - \text{current unit voltage}}{\text{floating charge current limiting point value}} \times \text{battery charging current set value}$$

Float Voltage(V): The voltage value of the float charging of the battery cell. When the voltage of the battery cell reaches this set value, the charging current approaches 0A.

When with BMS, calculate the maximum cell voltage sent by the BMS, otherwise calculate the average voltage.

BAT Charge Current(A): This value modify the charging current of the battery. Please set it according to the actual parameters of the battery to avoid significant losses caused by overcharging. When the battery with BMS, the BMS will send a maximum charging current limit and compare it with the charging current set on the screen, taking the smaller value for charging.

Name	Current Value	Set Value
Discharge Cut-off Volt(V)	1.900	1.900
Discharge Cut-off SOC	20	20
Re-discharge SOC	50	50
Charge Cut-off SOC	80	80
BAT Saturation	1	1
Trickle charge Set(kW)	1.0	1.0

Discharge Cut-off Volt(V): When the voltage of the battery cell reaches the discharge cut-off voltage, the battery stops discharging (Switch-on DG in Off-Grid mode or continue discharging until the undervolt activity then switches to PV-only mode).

Discharge Cut-off SOC: When the battery with BMS and the SOC reaches the set value, HPS will stop discharging. This only works in On-Grid mode; It does not works when the battery without BMS, and the discharge cut-off voltage is used for judgment.

Re-discharge SOC: When the battery with BMS, after triggers the discharge cut-off SOC and stops discharging. Only continue discharge when the SOC returns to the set value, and only works in On-Grid mode; It does not works when the battery without BMS, and BAT saturation is used as a judgment.

Charge Cut-off SOC: When the battery with BMS, the SOC reaches the set value and stops charging. It does not works when the battery without BMS; When this setting value activity simultaneously with the float charging voltage, whichever is reached first takes effect.

BAT Saturation: Only works in On-Grid mode, when the battery stops discharging and switches to charging due to undervoltage or discharge cut-off, the discharge can only be restored when the battery unit voltage reaches the set value.

$$\text{Recovery discharge unit voltage} = \text{floating charge unit voltage} - \frac{\text{battery saturation set value}}{10}$$

Trickle charge Set(kW): When reaching the discharge cut-off voltage or discharge cut-off SOC, charge battery with this power to prevent the battery voltage from being too low.

Name	Current Value	Set Value
BAT UnderVolt Warning(V)	1.850	1.850
BAT UnderVolt Protect(V)	1.800	1.800
BAT OverVolt Protect(V)	2.450	2.450
BAT OC Charge Protect(A)	100.0	100.0
BAT OC Discharge Protect(A)	100.0	100.0

BAT UnderVolt Warning(V): The cell voltage value during battery undervoltage fault. When battery with BMS, use the minimum cell voltage sent by the BMS to calculate, otherwise calculate based on the average voltage.

BAT UnderVolt Protect(V): The cell voltage value during battery undervoltage protection. When the battery voltage reaches this set value, HPS will shut down for protection. When battery with BMS, use the minimum cell voltage sent by the BMS to calculate, otherwise calculate based on the average voltage.

BAT OverVolt Protect(V): The cell voltage value during battery overvoltage protection. When the battery voltage reaches this set value, HPS will shut down for protection. When battery with BMS, use the maximum cell voltage sent by the BMS to calculate, otherwise calculate based on the average voltage.

BAT OC Charge Protect(A): The protection value of total battery charging current.

BAT OC Discharge Protect(A): The protection value of total battery discharging current.

Name	Current Value	Set Value
BMS Communication Enable	0	0
BMS Volt Judge Switch	0	0
PV Charge To Off-Grid(V)	0.000	0.000
Battery Share Enable	0	0

BMS Communication Enable: Set 1 for HPS communications with Battery, otherwise set 0.

BMS Volt Judge Switch: When the poor SOC calculation accuracy of BMS affecting system operation, require to use cell voltage for judgment, it is set to 1; otherwise, it is set to 0.

PV Charge TO Off-Grid(V): In PV only mode, if the battery cell voltage reaches the set value, it will automatically switch to Off-Grid mode.

Battery Share Enable: One HPS does not take effect. Parallel HPS takes effect: a. Battery connecting separately to HPS is set to 0 b. Battery connecting as a whole to HPS is set to 1.

Grid

Name	Current Value	Set Value
Max. Grid Voltage(V)	440.0	440.0
Min. Grid Voltage(V)	360.0	360.0
Max. Grid Freq(HZ)	52.00	52.00
Min. Grid Freq(HZ)	48.00	48.00
Output Power Limit(%)	100	100
Output Voltage(V)	400	400
Output Frequency(HZ)	50	50

Max. Grid Voltage(V): The maximum Grid voltage. Switch to Off-Grid mode when over this value. The default setting is 110%.

Min. Grid Voltage(v): The minimum Grid voltage. Switch to Off-Grid mode when under this value. The default setting is 90%.

Max. Grid Freq(HZ): The maximum Grid frequency. Switch to Off-Grid mode when over this value. The default setting is +2.

Min. Grid Freq(HZ): The minimum Grid frequency. Switch to Off-Grid mode when under this value. The default setting is -2.

Output Power Limit(%): AC output power percentage. Set from 1%-120%,the default setting is 100%,and recommend do not over 110%.

Output Voltage(V): Set for Off-Grid output voltage 380V or 400V. It may change based on site, restart HPS to change setting.

Output Frequency(HZ): Set for AC output frequency 50 or 60. It may change based on site, restart HPS to change setting.

Name	Current Value	Set Value
Max. Import from Grid(kw)	240	240
Max. Export to Grid(kw)	0	0
Max.Grid Charge Power(kw)	60.0	60.0
Grid Charge Cutoff SOC	80	80
Grid Charge Cutoff Volt(V)	2.450	2.450
Zero Export Enable	1	1
Grid & PV Charge Enable	1	1

Max. Import from Grid(kW): Maximum import power from Grid value.

Max. Export to Grid(kW): Maximum export power to Grid value, include PV. Available to set limit value.

Max. Grid charge power (kW): Maximum charging power from Grid, available to set limit value.

Grid Charge Cutoff SOC: BMS communication enable 1 and BMS voltage judgment enable 0 are activated. When Grid power is sufficient and Grid charging is allowed, charging can be up to the Grid charging cut-off SOC and Grid charging cut-off voltage during Battery first mode, Economic mode - Off peak, and Time schedule - Off peak. When Grid charging cut-off SOC or Grid charging cut-off voltage is reached, only the PV or CP charging is available, Grid does not charge the battery.

Grid Charge Cutoff Volt(V): Without BMS, BMS communication enable 1 and BMS voltage judgment enable 1 are activated. When Grid power is sufficient and Grid charging is allowed, charging can be up to the minimum of BMS cell voltage or battery cell voltage during Battery first mode, Economic mode - Off peak, and Time schedule - Off peak. When Grid charging cut-off SOC or Grid charging cut-off voltage is reached, only the PV or CP charging is available, Grid does not charge the battery.

Zero Export Enable: Set 1 for HPS not allow export power to Grid. Set 0 for HPS allow export power to Grid.

Grid & PV charge Enable: When set 1, Grid or GEN available to charge battery with PV simultaneously. PV will charge battery priority, and shortage will supply by Grid or GEN.

When set 0, Grid or GEN are not available to charge battery with PV simultaneously. PV will charge battery priority, Grid or GEN can charge battery when there is none of PV.

Name	Current Value	Set Value
Fully Zero Export Enable	0	0

Fully Zero Export Enable: Set 1, during load first mode, phase unbalance, load power will be the minimum phase power * 3. HPS will output this minimum power, and excess power will import from Grid.

ATS

Name	Current Value	Set Value
ATS Enable	1	1
ATS Com No.Enable	0	0
ATS Com No.	1	1
ATS Units	1	1
ATS CanA Baud Rate(kbps)	20	20

ATS Enable: When ATS from ATESS, set to 1. When ATS not from ATESS, set to 2. Distinguish between Grid and DG by dry contact signal.

ATS Com No.Enable: when you need to set the communication station number, first set the enable to 1, and then modify the station number. After modification, you must set enable to 0. Only corresponding Inverter and ATS should be turned on. The power should be turned off after setting is completed, so as to avoid repetition.

ATS Com No.: Do not set this for single unit. There are two scenarios for HPS parallel: 1, Each HPS works with one ATS, the same 485 address. 2, All HPS use one ATS, do not set.

ATS Units: Number of ATS.

ATS CanA Baud Rate(kbps): When HPS works with ATS, the CanA Baud Rate of ATS is the same as the CanB of HPS. Set ATS comm. station to 1. The default setting is 20kbps.

GEN

Name	Current Value	Set Value
GEN Enable	0	0
Max. GEN Power (kW)	2.40	2.40
Max. GEN Charge Power(kW)	0.0	0.0
GEN Off SOC	80	80
GEN On SOC	30	30
GEN Manual Control	0	0

GEN Enable: When GEN connects to the Grid input of HPS, set Gen enable to 1, otherwise set to 0. Set 1 when works with ATS too.

Max GEN Power(KW): The maximum import power from Gen (Load+Charge).

Note: Gen power cannot be less than the full load power. (Peak load)

Max GEN Charge Power(kW): The maximum charging power from GEN.

GEN Off SOC: DG mode and BMS enable is 1, when recent SOC is larger than GEN switch-off SOC, HPS sends dry contact signal to switch-off Gen.

GEN On SOC: It only takes effect when DG is enable and battery has BMS. In the off grid mode, when current soc is less than gen on soc, HPS sends dry contact signal to switch-on the generator.

GEN Manual Control: Gen manual switch. Set 1 for HPS sends dry contact signal to switch-on Gen, and set 0 for switch-off.

Parallel

Name	Current Value	Set Value
Parallel Enable	0	0
Number Of Parallel Units	2	2
Parallel Redundant Units	0	0
Parallel Address	1	1
Parallel Address Auto Switch Enable	0	0
System ID sign	1	1

Parallel Enable: Set 1 for activity parallel function, all device needs set to 1.

Number Of Parallel Units: Number of parallel units, 2 units set 2, 3 units set 3.

Parallel Redundant Units: When the parallel system is in a normal operating state, the maximum number of malfunctions that the machines can tolerate. This maximum value can be set to (the number of inverter parallel units - 1). When the number of malfunctions are higher than Parallel Redundant Units, HPS would give an alarm..

Parallel Address: Address for parallel system, do not repeat. Address must be set from 1, and continuous digits, number 1 for master.

Parallel Address Auto Switch: Set 1 to prevent conflicting parallel addresses from being set within the system after enabling it.

System ID sign: Monitoring distinguishes platform whether the devices are the same system and uses it to collect data. Setting the same non-zero number for devices in the same system here.

Mode

OnGrid	Current Value
Operation Mode	Economic mode
<input type="checkbox"/> Load First	<input type="checkbox"/> Battery First
<input checked="" type="checkbox"/> Economic mode	<input type="checkbox"/> Time Schedule
<input type="checkbox"/> Smart Meter mode	<input type="checkbox"/> Bat-Smart Meter

OnGrid

Operation Mode: Working mode (Load first; Battery first; Economic mode; Time schedule; Smart meter mode; Bat-smart meter mode).

Note: To access the settings page for the economic mode and the time schedule mode, click the arrow on the right.



Note: If the time period shown in the image above is used, all parameters in the following image should be set to zero. The time period in the above image is shared between the scheduling mode and the economic mode. The off-peak and peak times are only used in the economic mode.

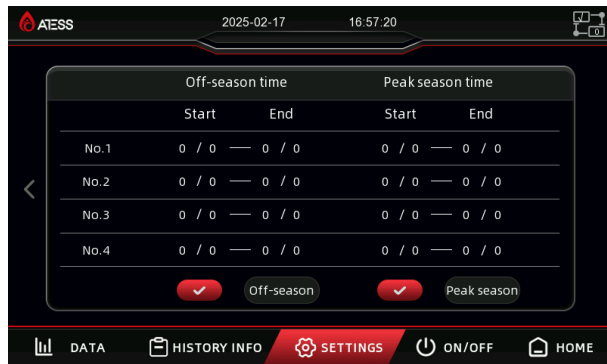

Description of economy mode:

Support off season and peak season time settings, as well as working and non-working day time Settings.

First of all, the electricity demand of a year is divided into off season and peak season, and the off-season and peak season can be set separately for the month range.

Second, after setting the month range, set the working day, Saturday and Sunday.

Finally, working days, Saturdays, and Sundays are set for on-peak, off-peak, and mid-peak periods, respectively. Among them, the corresponding mode in on-peak period is load first, the corresponding working mode in off-peak period is battery first, and the corresponding working mode in mid-peak period is that the battery is neither charged nor discharged.

Other

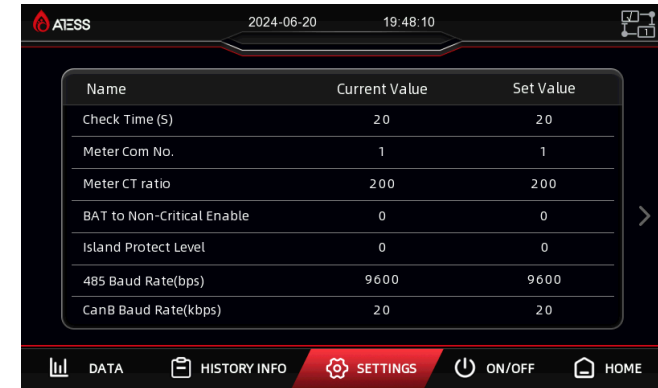

Check Time(S): Power-on self testing time

Meter Com No.: Communication address of meter

Meter CT ratio: Meter CT ratio

BAT to Non-Critical Enable: Set 1 for battery supply non-critical load

Island Protect Level: The protection function of preventing the HPS switch to Off-grid mode uncorrectly when grid unusual. Input range from 0-9, 0 indicates off, 1-9 indicates levels, it is recommended not set it too high

485 Baud Rate(bps): 485 baud rate of HPS, default setting is 9600

CanB Baud Rate(kbps): CanB baud rate of HPS, default setting is 20

Serial Number: equipment serial number, on the nameplate of the inverter

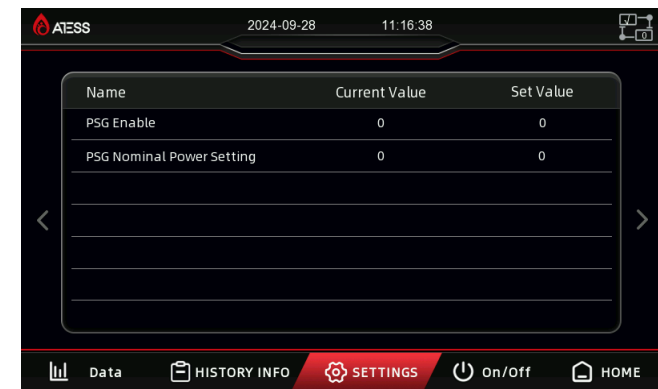

PSG Enable: With PV Inverter connected with the load,PSG Enable can be set to 1. Without PV Inverter connected with the load,PSG Enable can be set to 0. 232 convert 485 communication and 485communication are set to 1, 3rd party controller read the register address 229: (PSG Limit Power) from modbus protocol. CANB communication is set to 2, HPS send the percentage

of PSG rated power to 3rd party controller.

PSG Nominal Power Setting: The rated power of PV Inverter.

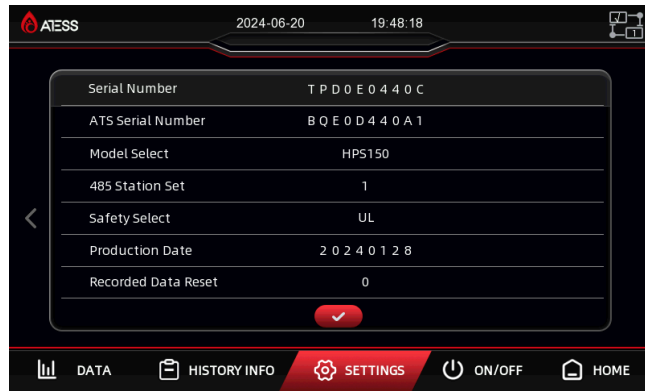

ATS Serial Number: ATS equipment serial number, on the nameplate of the ATS.

Model Select: select the model of HPS according to the actual model, and do not modify it. Due to the slight difference in the design of different models, the wrong model will lead to the failure to start and clear the parameter settings, resulting in unnecessary losses. If it needs to be modified for special reasons, please modify it under the guidance of ATESS after-sales team. After modifying the model, restart it to take effect.

485 Station Set: RS485 communication address setting. If it is a parallel system, must set it from 1.

Safety Select: safety Settings, default parameters, can not be modified.

Production Date: Set the factory production date.

Recorded Data Reset: The accumulated energy of Data is cleared to zero.

Protect Parameters

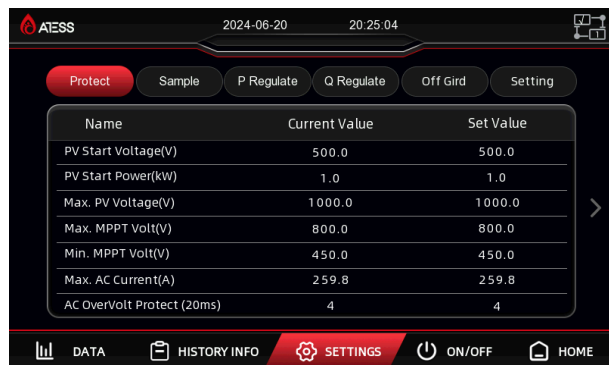

PV Start Voltage(V): MPPT tracks the PV starting voltage. Default setting is 450V.

PV Start Power(KW): MPPT tracks the maximum power if PV power is larger than PV starting power.

Max. PV Voltage(V): PV maximum voltage. HPS will report PV overVoltage fault and shutdown for protection if PV voltage is higher than PV maximum voltage.

Max. MPPT Voltage(V): PV maximum voltage for MPPT tracks the PV power.

Min. MPPT voltage(V): PV minimum voltage for MPPT tracks the PV power.

Max. AC Current(A): Maximum AC current. HPS will report Grid overCurrent fault and shutdown for protection when grid current more than 1.1 times.

AC OverVolt Protect (20ms): In Off-Grid mode, HPS triggers delay protection of AC overVoltage. Please do not modify it, to avoid affecting system operation normally.

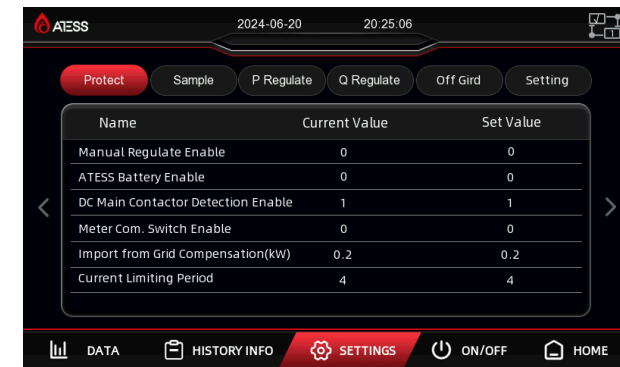

Manual Regulate Enable: Default setting is 1. Please modify it under the guidance of ATESS after-sales service team.

ATESS Battery Enable: Default setting is 0. Please modify to 1 when use with ATESS battery.

DC Main Contactor Detection Enable: Default setting is 1. Do not modify personally.

Meter Com. Switch Enable: Modify 0 for 3rd controller or Enerlog communication with smart meter via RS485. Modify 1 for HPS communication with smart meter via RS485. Modify 2 for HPS communication with smart meter via RS232 to RS485. Modify 3 for 3rd controller or Enerlog communication with smart meter via RS232 to RS485.

Import from Grid Compensation(KW): Force to import power from grid, and maximum is 10kW.

Current Limiting Period: Token bucket algorithm.

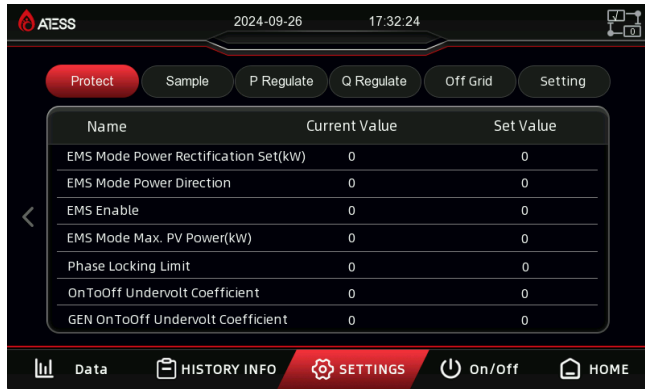

EMS Mode Power Rectification Set(kw): During EMS mode, the power of AC-DC or DC-AC.

EMS Mode Power Direction: During EMS mode, 0 is the direction of DC-AC, and 1 is the direction of AC-DC.

EMS Enable: Set 1 for run EMS mode, set 0 for quit EMS mode.

EMS Mode Max. PV Power(kw): During EMS mode, set for the maximum PV power.

Phase Locking Limit: During Off-Grid switching to On-Grid, the reaction speed of phase locking.

OnToOff Undervolt Coefficient: The coefficient of switching from grid mode to off grid mode is uses to adjust the condition(on to off grid).The default value is 100.

GEN OnToOff Undervolt Coefficient: The coefficient of switching from DG mode to off grid mode is uses to adjust the condition (DG on to off grid).The default value is 100.

Calibration Parameters

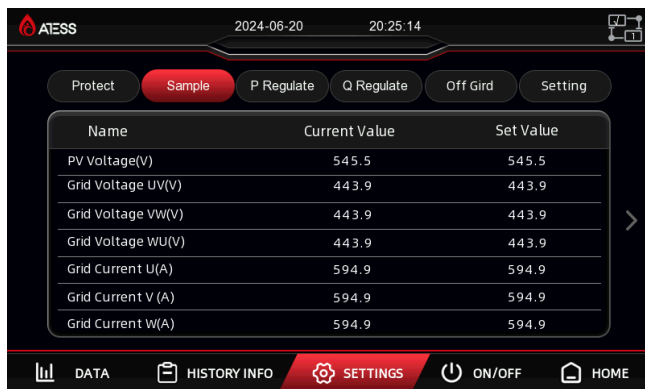

The settings are very important in this page, only modify it under the guidance of ATESS after-sales service team.

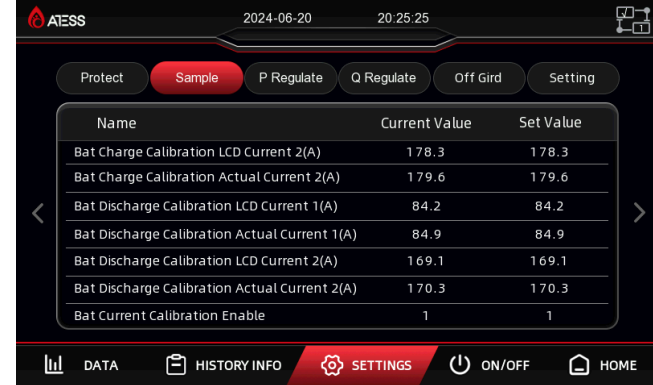
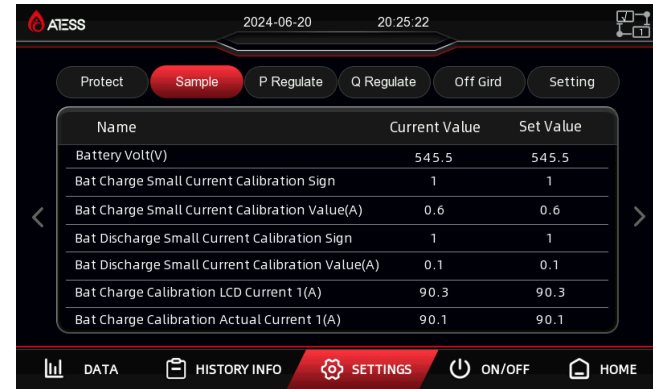

Battery Current calibration parameters. Important setting, only modify it under the guidance of ATESS after-sales service team.

Battery Current Calibration Enable: Keep enable to 0 when calibrating battery current. Set enable to 1 after changing it.

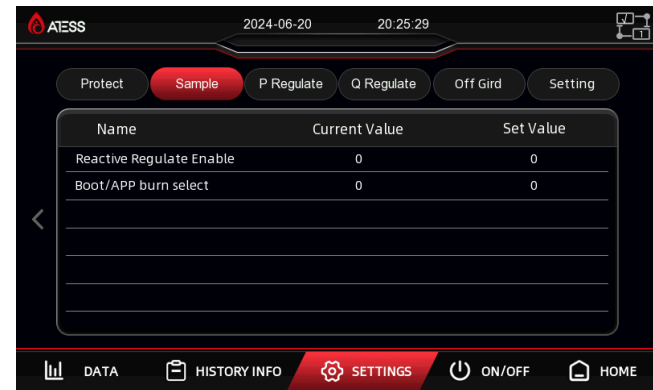

Reactive Regulate Enable: Set 1 for switch-on Reactive Power. Set 0 for switch-off.

Boot/APP burn select: Set 1 for burn from BOOT. Set 0 for burn from APP. The default setting is 0.

Reactive Power

Name	Current Value	Set Value
Mode_Opt: Reglq_Mode_Select	1	1
Mode1: Reglq_PF_Sign (0: lag 1: lead)	1	1
Mode1: Reglq_PF_Ref :	1.000	1.000
Mode3: Reglq_Q_Ref_Sign (0: lag 1: lead)	1	1
Mode3: Reglq_Q_Ref(kVar) :	0	0

Mode_Opt: Reglq_Mode_Select: Reactive power mode from 0 - 4.

Mode1: Reglq PF Sign(0:lagging 1:leading): Reactive power direction, 0 is lagging, 1 is leading.

Mode1:Reglq PF Ref: Reactive power compensation.

Mode3:Reglq Q Sign(0:lagging 1:leading): Reactive power direction, 0 is lagging, 1 is leading.

Mode3:Reglq Q Ref(kVar): Reference value of reactive power from Grid.

Grid Management

Name	Current Value	Set Value
Parallel PhaseSyn Compensation Coefficient	2.20	2.20
Parallel PhaseSyn Integral Coefficient	1	1
Parallel PhaseSyn Limit Coefficient	2.00	2.00
ActiveSag Coefficient	80	80
ReactiveSag Coefficient	6	6

Important setting, only modify it under the guidance of ATESS after-sales service team.

Name	Current Value	Set Value
Active Power Flow Kp	50	50
Active Power Flow Ki	25	25
Reactive Power Flow Kp	240	240
Reactive Power Flow Ki	240	240

Off-Grid current sharing value. Important setting, only modify it under the guidance of ATESS after-sales service team.

Protection Setting

Name	Current Value	Name	Current Value
Impact Load Current_Kp	0.600	Impact Load Voltage_Kp	1.900
Impact Load Current_Ki	0.0060	Impact Load Voltage_Ki	0.0050

Note: These data are only used for impact load when starting up.

Important setting, only modify it under the guidance of ATESS after-sales service team.

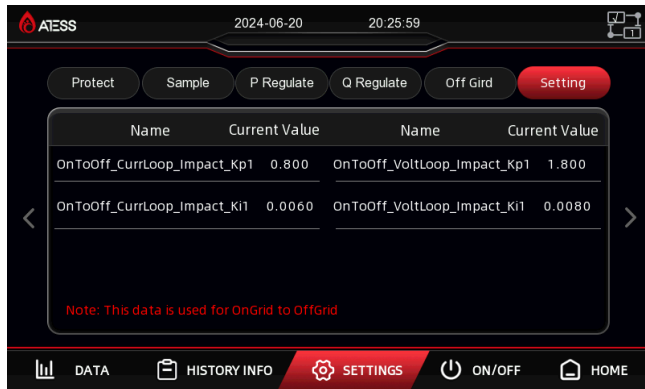
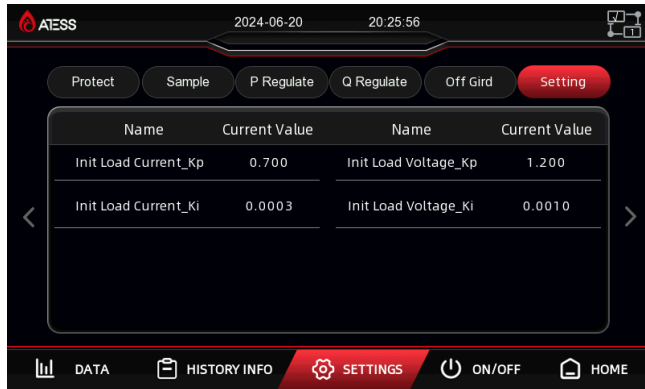

Important setting, only modify it under the guidance of ATESS after-sales service team.

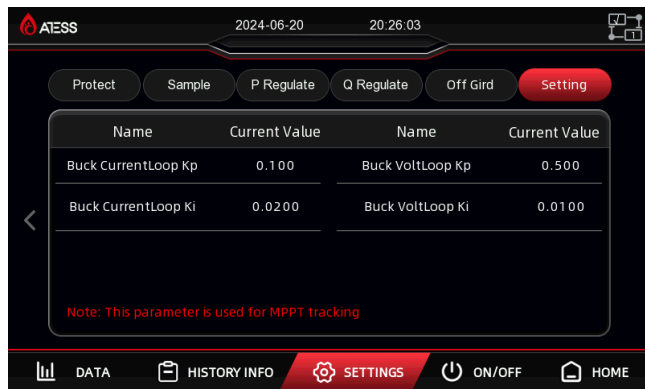

The page without instructions is the factory preset parameter, please do not modify. If the subsequent scheme changes, please modify the parameters under the guidance of ATESS.

7.3 LCD display information schedule

General history failure table

NO.	Information	
	English	Chinese
1	PV_Inverse_Failure	PV接反永久故障
2	IGBT_Failure	IGBT永久故障
3	EEPROM_Write_Failure	EEPROM写永久故障
4	EEPROM_Read_Failure	EEPROM读永久故障
5	AC_MainContactor_Failure	主接触器永久故障
6	AC_SlaveContactor_Failure	辅接触器永久故障
7	GFDI_Failure	GFDI永久故障
8	GFCI_Failure	GFCI永久故障
9	RISO_Failure	绝缘阻抗永久故障
10	PV_VoltHigh_Fault	PV电压高故障
11	Bypass_Communication_Fault	旁路柜通信故障
12	PV_CurrHigh_Fault	PV电流过流故障
13	BMS_Communication_Fault	BMS通信故障
14	PV_Insulation_Fault	PV对地绝缘阻抗故障
15	BMS_Fault	BMS故障
16	DC_OCP_Fault	直流过流故障 (Trip)
17	Smoke_alarm_Fault	烟雾报警故障
18	INT_PV_OverVolt_Fault	PV过压故障 (INT)
19	INT_PV_OverCurr_Fault	PV过流故障 (INT)
20	IGBT_Converter_Fault	控制器IGBT故障
21	IGBT_Buck_Fault	Buck IGBT故障
22	Converter_L_OCP_Fault	控制器电感过流故障 (Trip)
23	Buck_L_OCP_Fault	Buck电感过流故障 (Trip)
24	AC_NoUtility_Fault	交流无市电故障
25	AC_GridPhaseSeque_Fault	交流电网相序反故障
26	AC_PLL_Fault	交流锁相故障
27	AC_Volt_Unbalance_Fault	交流电压不平衡故障
28	AC_Curr_Unbalance_Fault	交流电流不平衡故障
29	AC_WU_OverVolt_Fault	交流WU过压故障

NO.	Information	
	English	Chinese
30	AC_WU_UnderVolt_Fault	交流WU欠压故障
31	AC_VW_OverVolt_Fault	交流VW过压故障
32	AC_VW_UnderVolt_Fault	交流VW欠压故障
33	AC_UV_OverVolt_Fault	交流UV过压故障
34	AC_UV_UnderVolt_Fault	交流UV欠压故障
35	AC_OverFreq_Fault	交流过频故障
36	AC_UnderFreq_Fault	交流欠频故障
37	AC_GridCurr_DcHigh_Fault	电网直流流量高故障
38	GridCurr_High_Fault	电网电流高故障
39	Buck_Module_OverTemp_Fault	Buck模块过温故障
40	Converter_L_OverTemp_Fault	变流器电感过温故障
41	Buck_L_OverTemp_Fault	Buck电感过温故障
42	Transformer_OverTemp_Fault	变压器过温故障
43	LowTemp_Fault	低温故障
44	EPO_Stop	紧急停机
45	KeyEmergencyStop	手动关机
46	LcdEmergencyStop	LCD关机
47	DC_MainContactor_Fault	直流主接触器故障
48	PV_Thunder_Fault	PV直流防雷器故障
49	AC_Thunder_Fault	交流防雷器故障
50	DC_SoftStart_Fault	DC软启故障
51	INT_ConverterL_OverCurr_Fault	变流器电感过流故障 (INT)
52	INT_BuckL_OverCurr_Fault	Buck电感过流故障 (INT)
53	Batt_OverVolt_Fault	电池过压故障
54	Batt_UnderVolt_Fault	电池欠压故障
55	Batt_OverCurr_Fault	电池过流故障
56	Batt_OverCharge_Fault	电池过充故障
57	Fault_Feedback_Warning	故障反馈告警
58	Batt_UnderVolt_Warning	电池欠压告警
59	AC_WU_OverVolt_Rmt_Warning	交流旁路WU过压
60	AC_WU_UnderVolt_Rmt_Warning	交流旁路WU欠压
61	AC_VW_OverVolt_Rmt_Warning	交流旁路VW过压
62	AC_VW_UnderVolt_Rmt_Warning	交流旁路VW欠压
63	AC_UV_OverVolt_Rmt_Warning	交流旁路UV过压
64	AC_UV_UnderVolt_Rmt_Warning	交流旁路UV欠压

7.4 General troubleshooting

If there is a fault during the operation, please click the LCD "history information" page to view the fault information. The following are the common fault analysis and handling steps of HPS:

1. Key emergency stop: turn HPS panel knob to "off" and handling steps: the knob is shut down normally, no need to handle.
2. LCD emergency stop: click "off" on HPS screen processing steps: the screen is shut down normally, no need to handle.
3. Emergency stop: emergency stop button pressed. handling steps: release the emergency stop button in case of no other abnormalities.

4. Batt_UnderVolt_Fault:

Possible reasons:

- a. The battery voltage sampled on the screen reaches the under-voltage protection condition and triggers it.
- b. The switch of battery on battery side or the on the energy storage controller is not turned on.
- c. If this fault occurs during operation, the battery voltage may be pulled down due to high-power output, or the battery itself may be defective.
- d. If it is a battery with BMS, this fault will also occur if the lowest cell voltage of the battery unit transmitted by the BMS to the energy storage controller reaches the protection condition.

Processing steps:

- a. First, check the battery connection, screen sampling error, and battery parameter settings.
- b. If it is a battery with BMS, check whether the BMS data meets the protection conditions.
- c. If there is no problem with the above, please contact ATESS for assistance.

5. Batt_OverVolt_Fault:

Possible reasons:

- a. The battery voltage sampled on the screen reaches the overvoltage protection trigger condition.
- b. If it is a battery with BMS, this fault will also occur if the highest cell voltage of the battery unit transmitted by the BMS to the energy storage controller reaches the trigger protection condition.

If there is a fault during the operation, please click the LCD "history information" page to view the fault information. The following are the common fault analysis and handling steps of HPS:

1. Key emergency stop: turn HPS panel knob to "off" and handling steps: the knob is shut down normally, no need to handle.
2. LCD emergency stop: click "off" on HPS screen processing steps: the screen is shut down normally, no need to handle.
3. Emergency stop: emergency stop button pressed. handling steps: release the emergency stop button in case of no other abnormalities.

4. Batt_UnderVolt_Fault:

Possible reasons:

- a. The battery voltage sampled on the screen reaches the under-voltage protection condition and triggers it.
- b. The switch of battery on battery side or the on the energy storage controller is not turned on.
- c. If this fault occurs during operation, the battery voltage may be pulled down due to high-power output, or the battery itself may be defective.
- d. If it is a battery with BMS, this fault will also occur if the lowest cell voltage of the battery unit transmitted by the BMS to the energy storage controller reaches the protection condition.

Processing steps:

- a. First, check the battery connection, screen sampling error, and battery parameter settings.

b. If it is a battery with BMS, check whether the BMS data meets the protection conditions.

c. If there is no problem with the above, please contact ATESS for assistance.

5. Batt_OverVolt_Fault:

Possible reasons:

a. The battery voltage sampled on the screen reaches the overvoltage protection trigger condition.

b. If it is a battery with BMS, this fault will also occur if the highest cell voltage of the battery unit transmitted by the BMS to the energy storage controller reaches the trigger protection condition.

Processing steps:

a. Check whether the number of battery cells and the overvoltage protection value are set correctly. If not, please set the parameters correctly.

If the parameters are correct due to the overvoltage of the battery itself, please contact ATESS for assistance.

6. Batt_OverCharge_Fault: the battery charging current is higher than the maximum charging current.

Processing steps:

Check whether the battery charging current setting value and the maximum charging current value are reasonable. The maximum charging current value of the battery shall be set according to the recommendations given by the battery manufacturer. The setting value of the battery charging current shall be less than the maximum charging current protection value.

7. Batt_OverCurr_Fault: the battery discharge current is higher than the maximum discharge current

Processing steps:

Check whether the maximum discharge current value of the battery is reasonable, multiply the maximum discharge current by the battery voltage, calculate the maximum discharge power of the battery, see whether it is less than the load power, if es, reduce the load power.

8. BMS_Fault: secondary or tertiary battery failure

Processing steps:

A. check the specific faults reported by BMS

B. contact the battery manufacturer to solve the problem

C. restart after troubleshooting

9. BMS_Communication_Fault: the energy storage inverter did not receive CAN data sent by battery BMS

Processing steps:

A. check whether the CAN line of BMS is connected to the CAN-A port of the inverter's control board.

B. check if the L and H CAN line are connected reversely.

C. check whether the CAN line is interfered. Suggest to use sampling shielded communication line.

D. use the CAN box to check whether there is data sent by the BMS on the bus.

E. if the communication still fails, contact ATESS.

10. Bypass_Communication_Fault: the energy storage inverter did not receive can data sent by bypass cabinet

Processing steps:

A. check whether the CAN line of ATS is connected to the CAN-B port of the inverter's control board.

B. check whether the L and H CAN line is connected reversely

C. check whether the CAN line is interfered. Suggest to use sampling shielded communication line.

D. use CAN box to check if there is data sent by ATS on the bus.

E. if communication still fails, contact ATESS.

11. AC_NoUtility_Fault: no AC voltage.

Processing steps: generally, this fault will not fade out because there is no output due to other reasons.

12. AC_OverFreq_Fault: the power grid frequency exceeds the upper limit, and the energy storage inverter enters off grid state.

Processing steps: check whether the upper limit of power grid frequency is reasonable. If yes, wait until it returns to normal, the inverter will automatically enter into grid connection state.

13. AC_UnderFreq_Fault: the power grid frequency is lower than the lower limit, and the energy storage inverter enters the off grid state.

Processing steps: check whether the lower limit of power grid frequency is reasonable. If yes, wait until the power grid frequency returns to normal, HPS will automatically enter into grid connection state.

14. AC_UV_OverVolt_Rmt_Warning: when the utility grid voltage is higher than the upper limit, the energy storage inverter enters off grid state.

Processing steps: check whether the upper limit setting of power grid voltage is reasonable. If yes, wait until the power grid voltage returns to normal, and HPS will automatically enter into grid connection state.

15. AC_VW_OverVolt_Rmt_Warning: when the grid voltage is higher than the upper limit, HPS enters off grid state.

Processing steps: check whether the upper limit setting of power grid voltage is reasonable. If yes, wait until the power grid voltage returns to normal, and HPS will automatically enter into grid connection state.

16. AC_WU_OverVolt_Rmt_Warnin: when the grid voltage is higher than the upper limit, HPS enters off grid state.

Processing steps: check whether the upper limit setting of power grid voltage is reasonable. If yes, wait until the power grid voltage returns to normal, and HPS will automatically enter into grid connection state.

17. AC_UV_UnderVolt_Rmt_Warning: when the grid voltage is lower than the lower limit, HPS enters off grid state.

Processing steps: check whether the lower limit setting of power grid voltage is reasonable. If yes, wait for the power grid voltage to return to normal, and HPS will automatically enter into grid connection state.

18. AC_VW_UnderVolt_Rmt_Warning: when the grid voltage is lower than the upper limit voltage, HPS enters off grid mode.

Processing steps: check whether the lower limit setting of power grid voltage is reasonable. If yes, wait for the power grid voltage to return to normal, and HPS will automatically enter into grid connection state.

19. AC_WU_UnderVolt_Rmt_Warning: when the grid voltage is lower than the upper limit voltage, HPS enters off grid state.

Processing steps: check whether the lower limit setting of power grid voltage is reasonable. If yes, wait for the power grid voltage to return to normal, and HPS will automatically enter into grid connection state.

20. AC_GridPhaseSeque_Fault: reverse phase sequence connection of power grid

Processing steps: check the three lines of phase sequence U V W of the utility grid, which are corresponding to A B C connected to the AC input terminal of inverter.

21. OverTemp_Fault: the temperature inside of the machine is too high.

Processing steps:

A. check whether the power supply micro break of the inverter is turned on. If not, turn it on.

B. check whether HPS air inlet and outlet are blocked, and clean dust regularly.

C. wait for the machine to cool down, the fault is eliminated and inverter restart normally, and observe whether the fan works when the temperature reaches 60 °C. If not, please contact ATESS.

Regarding other faults, please contact relevant professionals of ATESS.

7.5 Working mode

Please refer to Section 7.2.4 for details on operation mode setup procedure.



Caution!

Before the machine leaves the factory, the operation mode will be set according to the technical agreement. ATESS will not be responsible for the consequences caused by modifying the operation mode without the consent of ATESS. Please contact ATESS service team for modification if needed.

7.5.1 On-Grid mode

Optional functions in grid connection mode:

Zero export function enable

1. When Zero export function enable is set to 1, the excess power cannot export to grid
2. When Zero export function enable is set to 0, the excess power can export to grid.

Grid&PV charge together enable

1. When simultaneous charging function enable is set to 1, grid and PV can charge battery simultaneously.
2. When simultaneous charging function enable is set to 0, grid and PV can not charge battery simultaneously.

Please refer to Section 7.2.4 for setup procedure.

7.5.1.1 Load First mode (Zero-export function is optional)

1. PV is higher than load consumption, PV will priority supply load, then excess power will charge battery. If there still some power remain, when Non-zero export function is activated, PV can export to grid, the export to grid power can be set.
2. PV is lower than load consumption, PV and battery will supply load simultaneously.
3. When battery discharging until discharge cut-off SOC, PV and grid will supply load simultaneously. When load consumption is higher than PV and "max import from grid", load will force to take power from grid.

Note: In order to maintain the discharge cut-off SOC, there is a trickle charge start and end setting limit since BMS and inverter need take power from battery to remain their own running.

7.5.1.2 Battery First mode (Zero-export function is optional)

1. PV is higher than charge power, PV will priority charge battery, then excess power will supply load. If there still some power remain, when Non-zero export function is activated, PV can export to grid, the export to grid power can be set.
2. PV is lower than charge power, PV will priority charge battery, grid will supply load then charge battery. Grid charge power can be set, when grid charging until Grid charge power SOC, grid will stop charging.
3. Import from grid power can be set, when load consumption is higher than "max import from grid", battery and grid will supply load simultaneously.

7.5.1.3 Economy mode (Zero-export function is optional)

1. During Off-peak:

The working mode is same as battery-first mode.

2. During Mid-peak:

A. Battery doesn't discharge, grid won't charge battery.

B. PV is higher than load consumption; PV will priority supply load, then excess power will charge battery.

C. PV is lower than load consumption; PV and grid will supply load simultaneously. PV won't charge battery.

3. During On-peak:

The working mode is same as load-first mode.

Note: It supports the time period settings for off-season and peak-season, as well as the time period settings for working days and non-working days.

7.5.1.4 Smart meter mode (Zero-export function is optional)

1. PV is higher than the sum of critical load, non-critical load and charge power, PV will supply critical load and non-critical load first, then excess power will charge battery:

A. When Zero-export enable is activated, excess PV cannot export to the grid

B. When Zero-export enable is inactivated, excess PV can export to the grid, the export to grid power can be set

2. PV is higher than critical load and non-critical load, but lower than the sum of critical load, non-critical load and charge power, PV will priority supply the critical load and non-critical load, then excess power will charge battery.

3. PV is higher than critical load, but lower than critical load and non-critical load, PV will priority supply critical load, then excess power will supply non-critical load.

A. When BAT to non-critical load enable is activated, PV and battery will supply non-critical load together.

B. When BAT to non-critical load enable is inactivated, PV and grid will supply non-critical load together.

Note: The sum of PV power and battery power cannot higher than the rated power of HPS.

4. PV is lower than critical load, PV and battery will supply critical load together:

A. When BAT to non-critical load enable is activated, either battery or battery and grid will supply non-critical load.

B. When BAT to non-critical load enable is inactivated, grid will supply non-critical load.

Note: The sum of PV power and battery power cannot higher than the rated power of HPS.

7.5.1.5 Time schedule mode

1. On-peak (Set export to grid power is X)

A. When PV is higher than X, PV will priority export power to grid through HPS, then excess power will charge battery.

B. When PV is lower than X, PV will priority export power to grid through HPS, then battery will export the rest.

2. Off-peak (Set Grid charge power is Y)

A. When PV is higher than charge power, PV will priority charge battery, then excess power can export to grid, the export to grid power can be set.

B. When PV is lower than charge power, PV will priority charge battery, the insufficient will supply by grid. The max charge power will be the grid charge power. The grid will charge battery until grid charge cut-off SOC.

3. Mid-peak

Battery doesn't charging or discharging to grid. If PV is connected, it will priority charge battery, then excess power can export to grid, the export to grid power can be set.

7.5.1.6 Bat-Smart meter mode

1. PV is higher than charge power and critical load, PV will priority charge battery, then supply the critical load and non-critical load simultaneously.

A. When Zero-export enable is activated, the excess power cannot export to the grid.

B. When Zero-export enable is inactivated, the excess power can export to the grid, and the export to grid power can be set

2. PV is higher than charge power but lower than charge power and critical load, PV will priority charge battery, then excess power will supply the critical load, and grid will supply the rest of loads.

3. PV is lower than charge power, grid will priority charge battery, and then supply load.

7.5.1.7 EMS MODE

Description:

1. In EMS mode, HPS is fully controlled by EMS for charging and discharging, ATESS's all programmed working modes will invalid;

2. The power transmitted under EMS mode is still limited by the screen setting value;

3. It needs to be used with EMS;

4. the controlled power includes PV power and inverter rectifier power (only PV power can be controlled when it is not connected to the power grid, and the inverter power can be automatically adjusted according to the load conditions). When it is set as inverter, DC is output to AC. when it is set as rectifier, AC charges the battery. See the control instructions below for details.

Control Description:

No.	Diagram	Description
1	<p>All PV power charge to battery, DC-AC rectifier power remains 0</p>	<p>Keep the DC-AC rectifier power at 0, only modify PV power, at this time, PV is fully charged and AC has no power</p>
2	<p>PV power remains 0, all the DC-AC power send to AC</p>	<p>Keep PV power at 0, only modify the DC-AC power, at this time, the battery inverts to AC</p>
3	<p>PV power remains 0, all rectifier power charge to battery</p>	<p>Keep PV power at 0, and only modify the rectifier power. At this time, the AC charge battery</p>

4		<p>PV power higher than or equal to inverter power, PV convert to AC in priority, remaining charge to battery</p>
5		<p>PV power lower than DC-AC power, PV and battery output to AC together</p>
6		<p>PV and AC power charge battery together, when PV+AC power exceeds the max. charging value, use PV power to charge battery in priority</p>

7.5.2 Off-Grid Mode

1. PV is higher than load consumption, PV will priority supply load, then excess power will charge battery.
2. PV is lower than load consumption, battery will discharge. When battery discharging until GEN ON SOC, then,
 - A. If GEN is not connected, battery will discharge until "BAT underVlot Warning", HPS will stop AC output, switch to only PV charge battery.
 - B. If GEN is connected, HPS will switch-on GEN with dry contact control, then GEN will supply load and charge battery.

7.5.3 DG Mode

1. Generator connection (dry contact control)

In Off-grid mode: When battery discharging until GEN ON SOC (If no BMS, it will be GEN ON Voltage), HPS will switch-on GEN by dry contact to supply load and charge battery. HPS will consistently supply load during switching to GEN mode fully complete.

2. When GEN is fully complete started

A. When PV is higher than charge power, PV will charge battery only.

B. When PV is lower than charge power, PV will priority charge battery. GEN will supply load, then it is an option to let GEN charge battery or not according to customer's requirement.

C. When charging battery until GEN OFF SOC (If no BMS, it will be GEN OFF Voltage), HPS will switch-off GEN by dry contact then switch to Off-grid mode. When grid back, HPS will run Off-grid mode for a very short period, then switch to On-grid mode.



When temperature too high, output power of HPS will decrease, which is normal. However, if this happens frequently, check the cooling surface of the inverter or place it in a place with good ventilation condition. If the fan gets dirty, please clean the dust. If there is any problem inside HPS, please contact your local distributor or ATESS service team for help.

8 Routine Maintenance

8.1 Regular maintenance







Due to the influence of environment temperature, humidity, dust and vibration, the devices inside the HPS will be aged and worn, which will lead to potential failure inside the HPS. Therefore, it is necessary to carry out daily and regular maintenance to ensure its normal operation and service life. All measures and methods to help the HPS in good working condition belong to the scope of maintenance work.

8.1.1 Safety precautions

- (1) Only qualified and authorized personnel can maintain the HPS.
- (2) When carrying out maintenance work, do not leave the screws, washers and other metal parts in the HPS, otherwise the equipment may be damaged.
- (3) If only the circuit breaker is disconnected, the cable connection terminal inside the HPS is still electrified.
- (4) Before opening the cabinet door and starting the formal maintenance work, it is necessary to not only disconnect the circuit breaker, but also disconnect the front and rear level circuit breakers of the inverter.
- (5) After disconnect all the power of HPS, please wait at least 5 minutes before maintenance.
- (6) Disconnect all external connections and internal power supply of the HPS.
- (7) Ensure that the HPS is not inadvertently recharged.
- (8) Use a multimeter to ensure that the HPS is completely electrically neutral inside.
- (9) Make necessary grounding and short circuit connections.
- (10) Use insulating material cloth to cover the parts near the operation part that may be electrified.

8.1.2 System maintenance

Tools to be used during maintenance

	Cell phone that can take photos
	Multimeter
	Thermometer
	Pen and paper
	Spanner, screwdriver etc
	Thermal imager

2.1 Maintenance and inspection checklist for running system

When recording inspection and maintenance, inspection shall be carried out one by one following the table sequence, and the faulty items shall be described accordingly.

Please refer to Capture 10.3 Maintenance and inspection checklist for non-shutdown system.

After the inspection record is completed, photos of the operation status in home page and historical information page shall be taken for record, as shown in the following figures:

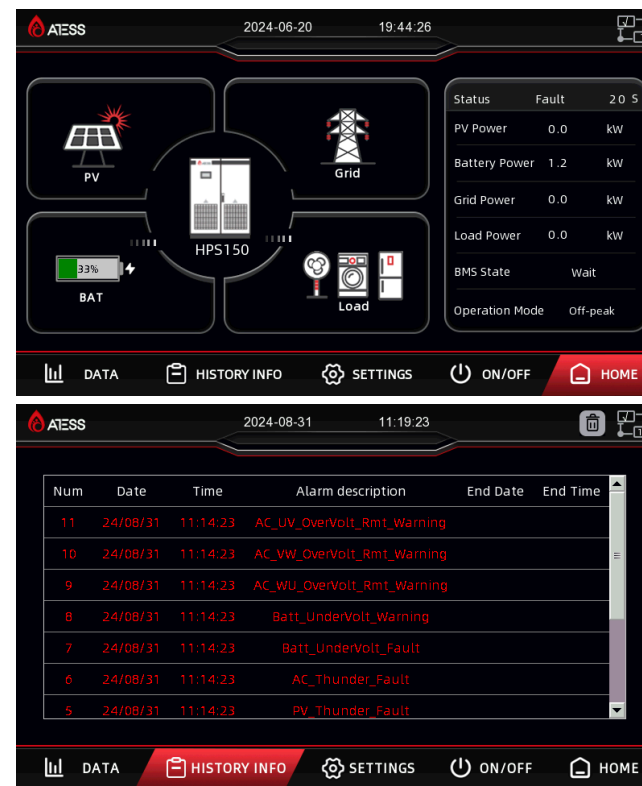

2.2 Maintenance and inspection checklist for shutdown system

Please refer to Capture 10.4 Maintenance and inspection checklist for shutdown system.

8.1.3 Relative operations



CAUTION!

All maintenance operations must be carried out in the condition that DC side and AC side of the inverter, PV module and AC distribution cabinet switch are all disconnected. Maintenance must be proceeded only after AC and DC disconnected for at least 5 minutes, in order to avoid electric shock!

Only professional technicians familiar with the system operation can perform such operation.

Disconnect the circuit breaker

Operate the DC switch of PV input and battery input to disconnect HPS from the PV and battery. And operate AC input and AC output switches to disconnect HPS from AC sources. Make sure that HPS won't switch on accidentally. Test with a multimeter to make sure the device is disconnected and with zero voltage. Even if HPS has been disconnected from the grid / main power supply, battery and PV, some of the internal components (such as capacitors) still have residual voltage and discharge slowly, so please wait at least 5 minutes after the circuit breaker is disconnected and use the multimeter to measure and confirm the safety before continuing operation.

How to use bypass switch

If the HPS fails and cannot continue to operate, it needs to be shut down for maintenance, while the load connected to the HPS needs to continue working, the bypass switch can be used to keep the load work uninterruptedly under the power supply of power grid or generator, and the maintenance personnel can carry out maintenance work safely.

Step 1: turn on the bypass switch in case of machine failure.

Step 2: turn off the switches of "AC input", "AC output", "PV input" and "battery input". At this time, the AC and DC power are disconnected from HPS, and the load is all supplied by the power grid, after the residual power is discharged, maintenance work can be carried out.

Note:

1. After power off, wait for 5 minutes to confirm safety before carrying out maintenance work.
2. Use the multimeter to ensure safety before disassembling and other work.

Function and safety parameters

Do not change parameters of HPS without the authorization of the local power supply company and the instruction of ATESS. Unauthorized change of functional safety parameters may cause injury to personnel or inverter damage, in this case, ATESS will not provide warranty services.

Replace the dust screen

During the use of HPS, the dust on the top shall be cleaned regularly, and the dust screen at the air inlet shall be cleaned or replaced. During the cleaning, HPS needs to be power-off.

Replacement method of dust screen: the dust filter cotton on the door panel can be directly pulled up for cleaning and replacement.

8.2 Waste disposal

The inverter will not cause environmental pollution, since the all the components meet the requirements of environmental protection. According to environmental protection requirements, user shall dispose the inverter in accordance with the relevant laws and regulations.

9.1 Specification

Model	HPS50	HPS100	HPS120	HPS150
PV parameter				
PV rated power	55KW	110KW	132KW	165KW
Max. PV power	75KW	150KW	180KW	225KW
Max. PV open circuit voltage	1000V	1000V	1000V	1000V
PV MPPT voltage range	480Vdc-800Vdc			
Max. PV input current	136A	230A	327A	409A
Battery parameter				
Battery operating voltage range	352V-600V			
Max battery charge current	150A	300A	350A	450A
Max battery discharge current	156A	313A	374A	467A
Max battery charge power	75KW	150KW	180KW	225KW
Max battery discharge power	55KW	110KW	132KW	165KW
AC output parameter				
Rated voltage	400Vac			
Rated current	72A	144A	173A	217A
Rated power	50KW	100KW	120KW	150KW
Rated frequency	50/60Hz			
Frequency Range	45-55Hz/55-65Hz			
Max. AC output power	55KVA	110KVA	132KVA	165KVA
Max. AC input power	100KVA	200KVA	240KVA	240KVA
Power factor	0.8lagging-0.8leading			
THDI	<3%(Full load)			
THDU	≤2%			
Overload capacity	110%-10 mins,120%-1 min			
Other parameter				
Ingress Protection	IP20			
Protective class	Class I			
Mains over voltage category	OVC III			
PV over voltage category	OVC II			
Demand response mode	DRM0-8 (optional)			
Inverter topology	Isolated			
Noise emission	<65dB (A) @1m			
Cooling	Intelligent air cooling			
Humidity	0%-95% non-condensing			
Maximum altitude	6000 (derate over 3000m)			
Build-in transformer	yes			
Operating temperature	-25°C-+55°C			
Active anti-islanding method	Shifting the frequency of the inverter away from nominal conditions in the absence of a reference frequency (frequency shift)			
Communication				
LCD display	Touch screen LCD			
Communication interface	RS485/CAN			

1.5 times rated PV output: HPS supports 1.5 times rated PV output at most, but the following two conditions(Battery voltage, PV MPPT voltage) need to be met.

Model	Battery voltage (current actual voltage)	PV MPPT voltage	Inrush current	Max.output overcurrent	Feedback current
HPS50	Above 500V	Exceed the max. battery voltage and above 550V	79.3A	86.6A	0A
HPS100	Above 500V	Exceed the max. battery voltage and above 650V	158.7A	173.2A	0A
HPS120	Above 520V	Exceed the max. battery voltage and above 550V	190.5A	207.8A	0A
HPS150	Above 500V	Exceed the max. battery voltage and above 550V	238.1A	259.8A	0A

There are diodes on the PV side to prevent PV reflux. In case of short circuit, HPS will immediately disconnect all contactors and circuit breakers to prevent other equipment from being affected.

Isolation transformer functions and specifications

1. Buck-boost function: Meet the minimum battery voltage of 352V.
2. Electrical isolation: isolate the primary and secondary to ensure safety.
3. Star-delta transformation: forming the N line.

Model	HPS50	HPS100	HPS120	HPS150
Rated capacity	50KVA	100KVA	120KVA	150KVA
Rated frequency	50/60Hz			
Primary rated voltage	200V			
Secondary rated voltage	400V			
Primary rated current	144.3A	288.7A	346A	433A
Secondary rated current	72.2A	144.3A	173A	216.5A
Connection group	Dyn11			
No-load loss	400W	485W	565W	700W
Load loss(75°C)	1500W	1700W	1900W	2400W
Temperature rise	≤75K			≤90K
Cooling	AF			
Insulation grade	H			
Ingress protection	Ip00			
Grounding mode	Neutral ungrounding			
Dielectric strength	3000V,60S,≤15mA		3000V,60S,≤20mA	

9.2 Inductive Load Conditions

9.2.1 AC Coupling Solution(Hybrid Solution)

When the HPS series is equipped with motor loads (such as water pumps, air conditioners, compressors, etc.), the following conditions must be met:

1. The total motor load rated power is not greater than half(50%) of the HPS rated power, and the maximum operating power is not greater than the HPS rated power;
2. When the rated power of a single motor is greater than 10KW or greater than one-eighth of the rated power of the equipment, a VFD is required.

	HPS30	HPS50	HPS100	HPS120	HPS150
Single Motor required VFD power (KW)	3.75	6.25	10	10	10
Total allowable power of motors (KW)	15	25	50	60	75
The total maximum operating power allowed by the motor(KW)	30	50	100	120	150

9.2.2 DC Coupling Solution(New Solution)

When the HPS series is equipped with motor loads (such as water pumps, air conditioners, compressors, etc.), the following conditions must be met:

1. The total motor load rated power is not greater than 70% of the HPS rated power, and the maximum operating power is not greater than the HPS rated power.
2. When the rated power of a single motor is greater than 10KW or greater than one-eighth of the rated power of the equipment, a VFD is required.

	HPS30	HPS50	HPS100	HPS120	HPS150
Single Motor required VFD power(KW)	3.75	6.25	10	10	10
Total allowable power of motors(KW)	21	35	70	84	120
The total maximum operating power allowed by the motor(KW)	30	50	100	120	150

9.2.3 VFD requirements

1. According to the specifications of mainstream VFD such as Inovance VFD: voltage range - 15%~+10%, frequency range 47HZ~53HZ/57HZ~63HZ, overcurrent 1.5 times rated current 60S protection.

9.2.4 Voltage drop time

1. Meet the above requirements within 20ms.

9.3 Ates Factory warranty

● Warranty period

The warranty period of HPS is three year. If otherwise specified in the contract, the contract shall prevail.

During the warranty period, the customer shall show the invoice and date of purchase to the service personnel of ATESS. At the same time, the nameplate mark on the product shall be clear and visible, otherwise, ATESS has the right not to provide warranty service.

● Warranty conditions

In the event of failure during the warranty period, ATESS will repair or replace the product free of charge; The customer shall Set aside some time to repair the faulty machine.

● Liability exemption

In case of the following circumstances, ATESS has the right not to conduct warranty:

1. Products without logo of ATESS Power Technology logo.
2. The product or component that has exceeded the valid warranty period of ATESS.
3. Failure or damage (such as high temperature, low temperature, too wet or dry, high altitude, unstable voltage or current, etc.) caused by working in beyond-specified environment or wrong installation, storage or use that violates the instructions.
4. Failure or damage caused by unauthorized installation, repair, modification or disassembly, except for those authorized by ATESS.
5. Failure or damage caused by using components that not supplied by ATESS.
6. Failure, damage or transportation damage caused by accident or human factors (operation error, scratching, carrying, bumping, improper voltage connection etc.).
7. Failure or damage caused by force majeure (such as earthquake, lightning, fire etc.).
8. Failures or damages caused by other factors rather than quality problems of the supplied product itself(including components).

9.4 Maintenance and inspection checklist for running system

No.	Category	Check item	Method/Tool	Standard	Result	Problem description	Check frequency
1	System operation status check	Whether the LCD display of the machine is in normal operation	Visual inspection screen	Operation status display is not "fault" or "serious fault"	Normal <input type="checkbox"/> Abnormal <input type="checkbox"/>		Once a month
2		Whether there is error recorded in history that caused shutdown	Visual inspection screen	No error caused shutdown	Normal <input type="checkbox"/> Abnormal <input type="checkbox"/>		
3		Whether the data transmission of monitoring device is normal	Monitoring web page / APP	Monitoring connection and data transmission are normal	Normal <input type="checkbox"/> Abnormal <input type="checkbox"/>		
4		Whether the fan rotates normally and the air outlet is normal (first check whether the temperature collected by the equipment reaches the fan opening condition, which normally is 60 °C)	Visual inspection Thermal imager	Normal rotation, normal air output	Normal <input type="checkbox"/> Abnormal <input type="checkbox"/>		
5		Whether the equipment has abnormal smell or sound	Smell, listen	No abnormal sound or smell	Normal <input type="checkbox"/> Abnormal <input type="checkbox"/>		
6		Emergency stop button (when the system is in standby mode)	Manual	The circuit breaker trips after pressing the emergency stop button	Normal <input type="checkbox"/> Abnormal <input type="checkbox"/>		

9.5 Maintenance and inspection checklist for shutdown system

No.	Category	Check item	Method/Tool	Standard	Result	Problem description	Check frequency
1	System cleaning	Whether there is water leakage or other foreign matters in the room or container	Visual inspection	No water leakage or foreign matter	<input type="checkbox"/> Normal <input type="checkbox"/> Abnormal		Once a month
2		Whether there are rodents and insects such as rats, geckos, cockroaches and ants in the cabinet	Visual inspection	No animals or insects	<input type="checkbox"/> Normal <input type="checkbox"/> Abnormal		
3	System cable connection (power-off inspection)	Whether the power cable connection is loose	Manual /Wrench	No looseness	<input type="checkbox"/> Normal <input type="checkbox"/> Abnormal		Once a month
4		Whether the communication cable connection is loose	Manual bolt driver	No looseness	<input type="checkbox"/> Normal <input type="checkbox"/> Abnormal		
5		Check equipment ground connection	Visual inspection /Multimeter	<=4Ω	<input type="checkbox"/> Normal <input type="checkbox"/> Abnormal		
6		whether the external connection of the equipment is damaged	Visual inspection	No damage	<input type="checkbox"/> Normal <input type="checkbox"/> Abnormal		
7		whether there is moisture or condensation inside the cabinet	Visual inspection	No condensation, no moisture	<input type="checkbox"/> Normal <input type="checkbox"/> Abnormal		
8		Whether there is obvious dust inside the cabinet	Visual inspection	No obvious dust	<input type="checkbox"/> Normal <input type="checkbox"/> Abnormal		
9	Internal cleaning	Whether the front and rear dust screens has blockage	Visual inspection	No blockage	<input type="checkbox"/> Normal <input type="checkbox"/> Abnormal		Once a month
10		Whether there is obvious damage inside the equipment	Visual inspection	No damage	<input type="checkbox"/> Normal <input type="checkbox"/> Abnormal		
11		whether there is obvious rust inside the cabinet	Visual inspection	No rust	<input type="checkbox"/> Normal <input type="checkbox"/> Abnormal		
12		Safety signs	Visual inspection	Safety signs are not shed	<input type="checkbox"/> Normal <input type="checkbox"/> Abnormal		

Note: the table only indicates the recommended maintenance frequency of the product. The actual frequency shall be determined according to the specific installation environment. The scale of power station, location and site environment will affect the maintenance frequency. If the operation environment is windy and dusty, it is necessary to shorten the period and increase the frequency.

9.6 EMS mode RS485 command(EMS mode is DRM mode)

	HPS50	HPS90/100	HPS120	HPS150
Power on command				
Power off command		01 06 00 00 00 01 48 0A		
Turn on EMS mode		01 06 00 00 00 89 CA		
Turn off EMS mode		01 06 00 20 00 01 49 C0		
Rectify AC→DC		01 06 00 20 00 00 88 00		
Inverter DC→AC		01 06 00 22 00 01 E8 00		
0% rater DC/AC power		01 06 00 22 00 00 29 C0		
25% rater DC/AC power		01 06 00 23 00 00 78 00		
50% rater DC/AC power	01 06 00 23 00 00 B9 C5	01 06 00 23 00 19 B9 CA	01 06 00 23 00 1E F8 08	01 06 00 23 00 26 F9 DA
75% rater DC/AC power	01 06 00 23 00 19 B9 CA	01 06 00 23 00 32 F9 D5	01 06 00 23 00 3C 78 11	01 06 00 23 00 4B 38 37
50% rated PV power	01 06 00 23 00 26 F9 DA	01 06 00 23 00 4B 38 37	01 06 00 23 00 5A F8 3B	01 06 00 23 00 71 B8 24
100% rated PV power	01 06 00 21 00 19 18 0A	01 06 00 21 00 32 58 15	01 06 00 21 00 3C D9 D1	01 06 00 21 00 4B 99 F7
	01 06 00 21 00 32 58 15	01 06 00 21 00 64 D8 2B	01 06 00 21 00 78 D9 E2	01 06 00 21 00 96 59 AE

RS485 instruction formula description

AB CD EF GH IJ KL MN OP

AB:485 communication address

CD:Function code

EF GH:Register address

IJ KM:Value

MN OP:CRC check value of the first 6 bits

The appendix only shows part of the power section instructions. Please write the required instructions according to the 485 instruction formula and control the ATESS Modbus RTU protocol.