



深圳时代能创能源科技有限公司
SHENZHEN ATESS POWER TECHNOLOGY CO.,LTD

深圳市宝安区石岩街道水田社区祝龙田路23号二层

GROWATT-ATESS Industrial Park, No.23 Zhulongtian Road, Shuitian Community,
Shiyan Street, Baoan District, Shenzhen

Tel: +86 755 2998 8492

Web: www.atesspower.com

Email: info@atesspower.com

Revised date: 2025-01-06

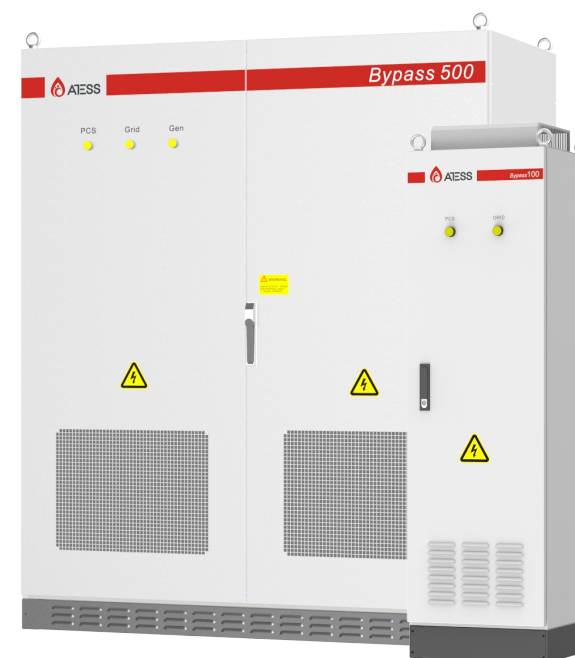

ATESS Bypass 100/250/500/630/1000

旁路柜用户手册

User Manual

目录

1 关于本手册

- 1.1 内容介绍
- 1.2 适用人员
- 1.3 手册使用

2 安全须知

- 2.1 符号说明
- 2.2 使用须知
- 2.3 正确安装方法
- 2.4 操作人员
- 2.5 重要的注意事项

3 产品描述

- 3.1 BYPASS
- 3.2 BYPASS电气原理
- 3.3 主要零部件布局
- 3.4 产品信息

4 产品运输及储存

- 4.1 产品的运输
- 4.2 产品的检查和储存

5 产品安装

- 5.1 安装条件要求
- 5.2 整机安装所需工具及零配件
- 5.3 机械安装
- 5.4 电气安装
- 5.5 通讯
- 5.6 系统接线

6 首次上电

- 6.1 运行前检查
- 6.2 上电

7 产品维护

- 7.1 日常维护
- 7.2 废旧处理

8 附件

- 8.1 产品规格
- 8.2 ATESS工厂保修

1 关于本手册

本章介绍了本手册的内容简介、面向的读者对象,能帮助用户更好的把握手册内容。

1.1 内容介绍

本手册适用于ATESS BYPASS产品(以下简称Bypass),手册包含以下主要内容:

- **安全须知**

Bypass相关安全事项。

- **产品描述**

Bypass功能、作用,以及Bypass自身的结构、原理,Bypass的尺寸包装。

- **产品运输与储存**

产品的运输方式,以及储存相关注意事项。

- **产品安装**

Bypass的安装条件、工具,Bypass机械和电气安装,通讯连接等信息。

- **产品首次上电**

Bypass第一次上电时必要的检查等信息。

- **产品维护**

Bypass的日常维护、废旧处理等信息。

- **附件**

Bypass的技术数据,质量保证条款等信息。

1.2 适用人员

适用人员需具备以下几点:

- 只有专业的电工或者具备专业资格的人员才能对本产品进行运输、安装等操作;
- 操作人员应充分熟悉整个储能系统的构成及工作原理;
- 操作人员应充分熟悉本产品的使用手册;
- 操作人员应充分熟悉项目所在国家/地区的相关标准。

1.3. 手册使用

在安装或者使用设备前,请仔细阅读本手册,请将本手册以及产品组件中的相应资料存放在一起,以保证相关人员可以方便获取和使用。

手册内容将不断更新、修正,难免存在与实物稍有不符或者错误的情况。用户请以所购买产品的实物为准,联系当地经销商或登录本公司网站: www.atesspower.com 下载索取最新版本的手册资料。

2 安全须知

2.1 符号说明

为了确保用户在安装本产品时的人身及财产安全，或高效优化地使用本产品，手册中提供了相关的信息，并使用适当的符号加以突出强调。以下列举了本手册中可能使用到的符号，请认真阅读，以便更好地使用本手册。

	危险 “危险”表示有高度潜在危险，如果未能避免将会导致人“危险”表示有高度潜在危险，如果未能避免将会导致人。
	注意 “注意”表示有潜在风险，如果未能避免可能导致设备无法正常运行和造成财产损失的情况。
	警告！电击危险 设备内含有交流和直流电源终端，必须单独断开每路电源后，至少等待5分钟，使用仪器测量确认安全后才可以进行维修。
	警告，火灾危险 仅适用于安装在混凝土或其他不可燃物上。
	PE端 此处为保护接地(PE)端，安装接地时需要牢固接地以保证人员的安全。
	电击危险 电容存在电击危险，断开所有电源等待5分钟确认安全以后，才可以移动盖板。

2.2 使用须知

所有BYPASS 安装和服务人员都必须经过培训，并且熟悉在电气设备上工作时遵守方法守的一般安全规定。安装和服务人员还应熟悉地规和安全要求。

- 使用前请仔细阅读本手册，若未按本手册中的说明进行操作而出现设备损坏，本公司有权不进行质量保证；
- 只有合格的电气工程师才能对BYPASS 进行操作；
- 所有的电气操作必须符合当地电气操作标准。

2.3 正确安装方法

正确安装BYPASS 意味着遵循用户手册中的全部说明，涉及设备的运输、安装、电气连接和运行。时代能创能源科技公司对于因未正确使用设备而造成的任何损坏不承担责任。

BYPASS 具有IP20的保护等级，是为室内安装设计的。当安装BYPASS 时，必须注意用户手册所包含的信息，特别是第5章“产品安装”。正确使用设备还需要注意以下几点：

- 注意此处及以下部分列出的安全说明；
- 注意BYPASS 用户手册说明；
- 考虑与设备相关的技术数据。

2.4 操作人员

只有经过培训并得到供电公司批准的电工才可以安装并试运行BYPASS 。安装使用BYPASS 前，所有安装和服务人员都必须经过培训，并且熟悉操作电气设备时要遵守的基本安全要求。安装和服务人员还应熟悉相应的地方法规和安全要求。

2.5 重要的注意事项



注意1：静电可能导致BYPASS 损坏

BYPASS可能由于静电放电而造成内部元器件的不可恢复的损坏！

当操作BYPASS时，必须遵守防静电防护规范！

注意2：使用限制

BYPASS不可直接用于连接生命辅助设备和医疗设备！

注意3：工具注意事项

在BYPASS开机前应检查所有安装工具或其他不必要的物品遗留在BYPASS内部！

注意4：维护注意事项

维护时，必须保证该BYPASS已安全断电且机器所有带电器件放电完毕，方可操作！

3 产品描述

3.1 BYPASS

时代创能源科技生产的BYPASS是一款与我们公司PCS配套使用的机器，主要功能：

1、使PCS能实现并离网快速切换，保证不间断供应负载。2、使PCS系统能同时接入电网与油机。3、使系统能搭配光伏逆变器使用（要搭配逆变器使用，需要与我们公司的售前人员确认该逆变器是否能兼容到PCS系统中）。

3.2 BYPASS 电气原理

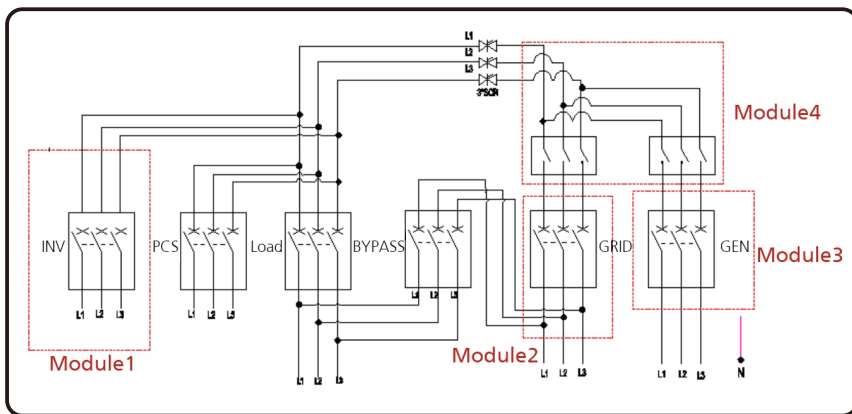

模块一	光伏接入	该模块实现光伏逆变器接入的功能，只能选用ATESS生产的逆变器。若选用其他逆变器需提前跟研发确认是否能实现光伏逆变器接入。
模块二	电网接入	该模块接入实现PCS与电网之间的并离网切换功能
模块三	油机接入	该模块接入实现PCS与油机之间的并离网切换功能
模块四	实现选择油机或电网接入功能	该模块是在同时接入油机和电网时才需要。如果只接入油机或电网其中一个是没有该模块。

3.3 主要零部件布局

3.3.1 外部零部件

BYPASS的外部器件只有指示灯。

指示灯

BYPASS采用智能化设计。通过门板上三个指示灯可以知道BYPASS当前的得电状态。只有同时接油机和电网功能的才有三个指示灯。



LED	含义
PCS	该指示灯亮起，代表PCS交流侧有电，能正常给负载供电
Grid	该指示灯亮起，代表电网侧有电
GEN	该指示灯亮起，代表油机侧有电。

3.3.2 内部零部件

BYPASS内部器件包括PCS断路器，光伏断路器，电网断路器，维修开关，油机断路器，负载断路器、晶闸管，供电微断及PCB板件等。

注：BYPASS为根据客户需求定制的功能柜。需求不一样，内部器件也不一样。下图是具备完整功能BYPASS500正面布局图（另外型号不一样，布局图有所不同）

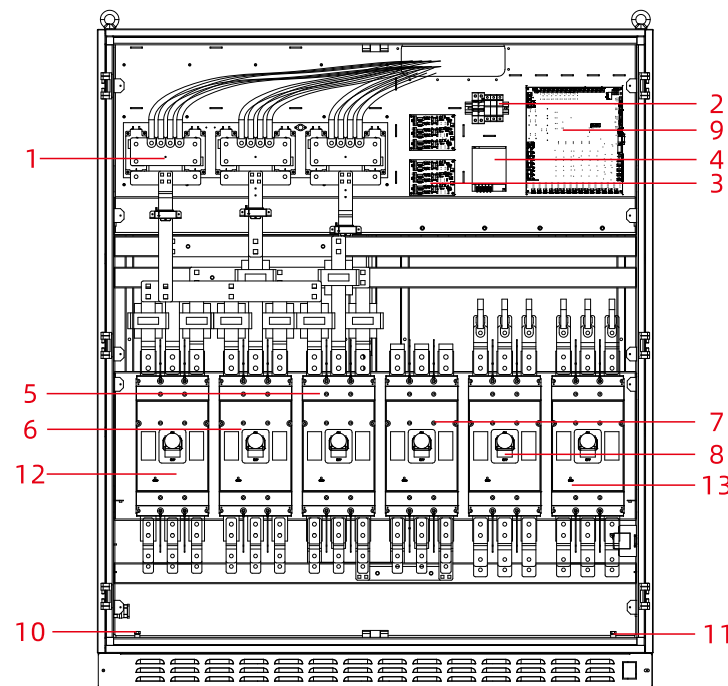

The front structure drawing of BYPASS

序号	部件名称	说明
1	晶闸管	并离网切换开关
2	供电微断	控制板电源的连接和断开
3	驱动板	晶闸管的驱动电路板
4	明纬电源	给控制板提供电源
5	负载断路器	控制与负载的连接和断开
6	PCS断路器	控制与PCS的连接与断开
7	维修断路器	维修开关
8	电网断路器	控制与电网的连接和断开
9	控制板	负责BYPASS的控制逻辑以及与PCS的通讯
10	N排	负载, 电网N线接线端子
11	地排	机器接地铜排
12	光伏逆变器断路器	控制与光伏逆变器的连接和断开
13	油机开关	控制与柴油发电机的连接和断开

4.1 产品的运输

用户在运输BYPASS时，只允许使用用户手册中描述的运输方法，运输时请考虑BYPASS的重量和其非居中的重心。重心已在包装箱上标出。



危险！

BYPASS很重，在运输BYPASS时，必须要有合格的起重设备和人员，BYPASS必须按照重心标识垂直于水平面直立运输，运输时BYPASS相对于直立放置的倾斜度不能超过10度，不允许将设备倒置或以水平位置运输，如果不能正确地吊运和运输BYPASS，可能导致严重的人生安全、财产损失和BYPASS损坏。

4.2 产品的检查和储存

用户在签收运输公司送来的BYPASS前，应仔细地进行检查。将收到的物品与交货通知单中列出的项目进行验收，如发现任何缺陷或损坏，应立即通知运输公司并要求其对设备进行鉴定。如果有需要，您可向深圳时代能创能源科技有限公司寻求帮助。



注意

该设备只能封装贮存，因此要确保对其内部的防尘和防潮，如果贮存的时间较长，BYPASS必须存放在干燥的环境中以防进入BYPASS。

3.4 产品信息

3.4.1 尺寸重量

型号	裸机尺寸(宽高深mm)	净重(KG)
BYPASS100	W700*D500*H1630	135
BYPASS250	W700*D500*H1800	205
BYPASS500	W1600*D800*H1900	900
BYPASS630	W1600*D800*H1900	1040
BYPASS1000	W2850*D800*H2100	1500

表-- BYPASS 的尺寸重量

注：旁路柜是根据项目需求定制机器，实际尺寸重量与上表有偏差，实际准确数据可联系销售提供。

3.4.2 包装信息

序号	名称	单位	数量	说明
1	BYPASS整机	台	1	包含机柜钥匙
2	用户手册	本	1	
3	合格证	份	1	
4	出厂测试报告	份	1	

表-- 产品包装信息

5 产品安装

5.1 安装条件要求

为了确保机器能够正常工作，安装的环境和要求如下：

- 本BYPASS 的防护等级为IP20，同时该产品为电气设备，故不要放置在潮湿的地方；
- 安装在室内，避免阳光照射和雨淋；
- 机器周围通风较好；
- 安装环境清洁；
- 设备在运行过程中会产生一些噪声，尽量安装在远离居民生活的地方；
- 安装地面确保不会晃动，支撑面应满足BYPASS 的承重要求；
- 安装位置应确保便于维护；
- 环境温度在-25℃~55℃之间；
- 机器应预留足够的空间保证通风散热

BYPASS 建议安装在配电室内，配电室的地面、空间、线缆沟、风道、通风设备及各项防护措施都需要经过严格的设计，并满足以下各项要求。

● 地基要求

本BYPASS 需要安装在表面为阻燃材料的平整地面或槽钢支撑结构上，地面禁止出现凹陷或倾斜的情况。必须保证地基坚实、安全可靠。地基必须具备承受BYPASS 重量的承重能力。

● 空间要求

在安装BYPASS 时，与墙壁或其他设备之间必须保留适当的距离，以便满足最窄维护通道、逃逸路线和通风的要求。

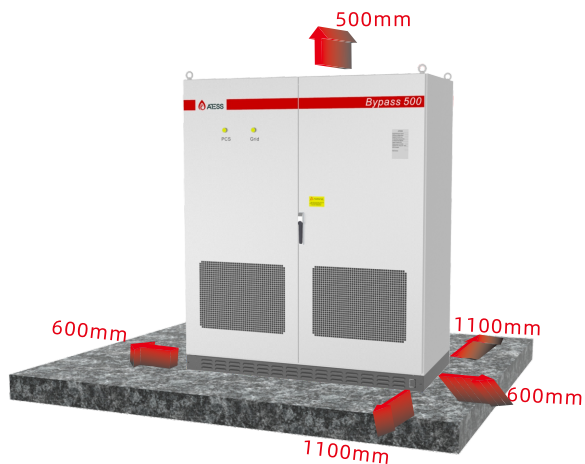

BYPASS 安装位置的前方应当保证大于1.5m的空间，背部应当保证大于0.8m的空间，顶部应当保证大于0.8m 的空间以方便安装，散热与维护。

● 线缆沟设计

BYPASS 的电缆连接采用下进线出线方式，建议BYPASS 与外部连接的线缆均从线缆沟走线，便于安装、维护。

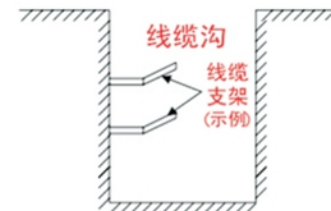

线缆沟通常由施工方按照相关标准进行设计施工，需考虑设备的重量及尺寸。线缆沟之间以及线缆沟和接地电极之间都需要良好的电气连接。

● 布线规范

系统使用的电缆一般可分为电力电缆及通讯线缆线。在铺设通讯线缆时，需要远离电力电缆，电缆在交叉处需保持直角。铺设时尽量使电缆长度最短，且要与电力电缆保持距离。

电力电缆及通讯线缆线应分别放在不同的线缆沟中，以避免电力电缆和通讯线缆长距离并行走线，以减少输出电压瞬变产生电磁干扰。电力电缆及通讯线缆线之间的距离应大于0.2m。当导线交叉分布时，应使交叉角度为90度，而距离可适当减少。

● 通风要求

BYPASS 运行时会产生热量，当环境的温度过高时会影响设备的电气性能，甚至会损坏设备，所以在设计操控室时需要充分考虑这些热量的释放，以确保设备正常高效的运行。

● 通风环境

为满足BYPASS 的通风要求，安装环境需满足以下条件：

- ※ BYPASS 应避免安装在通风条件差、气流量低的场所；
- ※ 进风口应有充足的空气补充。

● 通风设备

为了保证设备安全可靠高效运行，设备运行的环境温度必须在-25℃~55℃范围内，因此须配有适当的通风装置，将设备产生的热量散发出去，建议BYPASS 安装空间的通风量至少在3665m³/h以上。

1. 配电室内必须有通风设施，确保BYPASS产生的废热能排离设备，以符合允许的最大环境温度。可通过安装排气装置（例如风机、通风管道等）来实现；
2. 为保证压力均衡，可在出风管道出口处另加向外排风的风扇；
3. 出风口的朝向应根据当地风向的实际情况选择朝向；
4. 注意进风口、出风口的防尘措施及防淋雨设计；
5. 若需要加通风管道，则通风管道的尺寸应根据出风量的大小且应由专业人士设计。

其他防护

BYPASS的防护等级为IP20，适合安装在干燥、清洁的电站环境中。同时需要注意避免房屋漏水损坏BYPASS。根据EMC要求和噪音级别，BYPASS应安装在工业环境中。

5.2 整机安装所需工具及零配件

安装需要使用的工具以及零件如下：

- 起重吊车、铲车或叉式自动装卸车（具备承载BYPASS重量能力）；
- 扭矩扳手；
- 螺丝刀；
- 剥线钳；
- 端子压着机；
- 热吹风机；
- 兆欧表以及万用表。

5.3 机械安装

5.3.1 带包装的整机运输

相关注意事项

BYPASS采用整体运输方式，用户可以通过叉车从底部抬起，或是通过起重机、吊车移动。

注意1：BYPASS为一个整体，无论运输或安装时都不得将其分解。未经时代能创能源科技授权的改装造成的故障不在质保范围内。

注意2：在移动过程中不能使BYPASS倾斜、激烈晃动或突然受力，如突然放下抬起。

注意3：仔细阅读所标的参数以选择合适的运输工具及存放地点。

建议用户尽量使用叉车移动BYPASS。



在将BYPASS机柜移动到预定位置之前，建议先将电源电缆铺设好，由于这些电缆都比较粗，一旦安装了BYPASS机柜，将很难进行电缆布线操作。

运输过程中为了确保BYPASS处于较好的防护状态，尽可能带包装运输，并按照包装上各种标识的示意进行运输，包装标识图示说明如下：

图标	示意
	重心标识
	起吊标识
	正面朝上，禁止BYPASS横放、倾斜或者倒置
	小心轻放，避免运输环境中过于激烈的碰撞摩擦对BYPASS造成损坏
	注意防潮，避免BYPASS遭受雨淋或受潮

未拆卸包装的BYPASS可以使用叉车、起重机货叉或者吊车进行移动。移动时，需要注意包装上所标的重量，确保叉车、起重机货叉或者吊车具备足够的承载能力。BYPASS的重心在前后、左右对称，偏下部的的位置，运输时应合理排布支撑或起吊点。

叉车运输方式是标准运输方法。运输时箱体的重心应落在叉车的两根货叉之间。BYPASS的尺寸较大可能会挡住驾驶员的视线，应由辅助人员配合。

5.3.2 不带包装的BYPASS运输

● 拆除BYPASS包装

请按照以下步骤拆卸设备运输包装箱。

步骤1：拆卸包装箱的木质侧边与顶板；

步骤2：拆除机器上的外设包装材料；

步骤3：拆除机器与木板间的紧固螺丝。

① 拆除底座前后盖板；

② 旋下BYPASS与木托盘底部连接的紧固螺母；

③ 取出螺丝即可将BYPASS与运输木托盘分离。

● 裸机的移动安装

已经拆卸包装的BYPASS可使用叉车、起重机、滑轨或者吊车进行移动。如果拆卸包装的地点离最终安装位置稍远，可以先带底部木托盘运输。

若BYPASS底部木托盘已经移除，则在使用叉车移动BYPASS时，需要先将底座的前后盖板拆除，并使重心位置落在两叉车中间，再进行起重搬运，见下图：



危险!

在用叉车移动BYPASS时，动作一定要慢且轻，避免使BYPASS震动过大，或其他物体撞击，以免造成对人身安全及BYPASS的损坏。

如果使用起吊方式进行移动，请注意起吊位置，需要保证起吊的角度70°，并注意BYPASS的重心位置。

注意:

- 必须时刻要注意BYPASS的重心位置;
- 采取必要的辅助措施确保运输人员安全;
- 采取必要的辅助措施确保设备完好运送至最终安装地点。

5.4 电气安装

5.4.1 输入输出要求



危险!

- BYPASS工作时存在高压电击危险，只有具备专业技能的电工才可以对BYPASS进行操作。
 - 所有与设备连接的操作都必须无电压状态下进行。
 - 如果接错了输入、输出端子，将会损坏BYPASS!
- 如果不按照本警告信息去做，可能导致严重的人身伤害或重大的财产损失，甚至死亡。

● 负载

负载接入总功率应在BYPASS容量之内。

● 三相电网

电网要求为三相电网。电网等级应该按照前期协定等级接入。否则，由于电压等级问题造成机器损坏不在维修范围。

● 线缆要求

1. 请根据电压等级选择相应的耐压电缆。

2. 由于不同的电压值会导致电流大小发生变化，请根据实际电压范围计算相应的电缆线径。以下表格仅提供最低工作电压的线缆要求。仅供参考。

	BYPASS100		BYPASS250		BYPASS500		BYPASS630		BYPASS1MW	
	线径大小要求(mm ²)	安装孔位	线径大小要求(mm ²)	安装孔位	线径大小要求(mm ²)	安装孔位	线径大小要求(mm ²)	安装孔位	线径大小要求(mm ²)	安装孔位
PV输入端	每一相至少一根 75mm ² 线	Φ8	每一相至少一根 75mm ² 线	Φ8	每一相至少三根 95mm ² 线	Φ10	每一相至少四根 95mm ² 线	Φ10	每一相至少五根 120mm ² 线	Φ10
PCS输入端	每一相至少一根 75mm ² 线	Φ8	每一相至少一根 75mm ² 线	Φ8	每一相至少三根 95mm ² 线	Φ10	每一相至少四根 95mm ² 线	Φ10	每一相至少五根 120mm ² 线	Φ10
负载输入端	每一相至少一根 75mm ² 线	Φ8	每一相至少一根 75mm ² 线	Φ8	每一相至少三根 95mm ² 线	Φ10	每一相至少四根 95mm ² 线	Φ10	每一相至少五根 120mm ² 线	Φ10
电网输入端	每一相至少一根 75mm ² 线	Φ8	每一相至少一根 75mm ² 线	Φ8	每一相至少三根 95mm ² 线	Φ10	每一相至少四根 95mm ² 线	Φ10	每一相至少五根 120mm ² 线	Φ10
油机输入端	每一相至少一根 75mm ² 线	Φ8	每一相至少一根 75mm ² 线	Φ8	每一相至少三根 95mm ² 线	Φ10	每一相至少四根 95mm ² 线	Φ10	每一相至少五根 120mm ² 线	Φ10
N线	每一相至少一根 75mm ² 线	Φ8	每一相至少一根 75mm ² 线	Φ8	每一相至少三根 95mm ² 线	Φ10	每一相至少四根 95mm ² 线	Φ10	每一相至少五根 120mm ² 线	Φ10
地线	至少25mm ² 的线(使用专门的黄绿线)	Φ8	至少35mm ² 的线(使用专门的黄绿线)	Φ8	至少75mm ² 的线(使用专门的黄绿线)	Φ8	至少75mm ² 的线(使用专门的黄绿线)	Φ8	至少95mm ² 的线(使用专门的黄绿线)	Φ8
通讯线	0.75mm ² 使用专门的双绞屏蔽通讯线		0.75mm ² 使用专门的双绞屏蔽通讯线		0.75mm ² 使用专门的双绞屏蔽通讯线		0.75mm ² 使用专门的双绞屏蔽通讯线		0.75mm ² 使用专门的双绞屏蔽通讯线	

需根据定制功能机型选择对应端口接入，需求不同，接入端口也不一样。

5.4.2 电网侧接线



危险!

连接交流电网时，将交流配电柜断路器断开，保证接到端子的交流线不带电。

BYPASS 的交流侧输出电压为 400V。BYPASS 交流侧与电网侧的接线方法如下：

步骤1：断开电网侧断路器，用万用表测量确认接线端子已经断电。

步骤2：确定交流连接电缆的相序。

步骤3：剥掉电缆末端的绝缘皮。

步骤4：压接接线铜鼻。

1.将剥好的线头裸露的铜芯部分放到接线铜鼻的压线孔内。

2.使用端子压着机将接线铜鼻压紧，压接数量应在两道以上。

步骤5：安装热缩套管。

1.选择与电缆尺寸较符合的热缩套管，长度选择约 5cm。

2.将热缩套管套在接线铜鼻上，以完全覆盖接线铜鼻的压线孔为适。

3.用热吹风机使热缩套管缩紧。

步骤6：连接“L1”线缆到交流配电柜的“L1”即 A (U) 相。选用和接线铜鼻符合的螺栓。

步骤7：按照步骤 6 的方法连接交流输出的“L2”连到交流配电柜的“L2”，即B (V) 相；连接交流输出的“L3”连到交流配电柜的“L3”即 C (W) 相；连接N线，连接到机器N排。

注意：

1、如果选配了光伏接入功能，接线步骤与电网接线步骤1到5一样，然后确认光伏输出相序，依次接在光伏接入端口。

2、如果选配油机接入功能，接线步骤与电网接线步骤1到5一致，然后确认油机输出相序，依次接在油机接入端口，N线连接到N排上。

3、负载接入，接入步骤与电网接入步骤1到5一致，然后确认相序，依次接到负载接入端口，负载N线接到N排上。

5.4.3 连接地线

为了保证安全，需要将所有的BYPASS 都通过PE导体接地。BYPASS 柜内的PE铜排已经在柜内与BYPASS 的外壳可靠连接，进行 PE连接时需要将PE接地铜排与安装场地或电气操控室的等电位连接装置可靠连接。接地线线缆径不小于负载线缆线径的一半，接地电阻不得高于4Ω。

接线进出口置于BYPASS 底部，待所有的接线完毕后，接线进出口必须用防火泥密封，防止灰尘和小动物进入BYPASS 内部。



在PE铜排上接几根连接线，那是BYPASS 内部个别器件需要接地，请不要私自更改，以免造成触电危险！

5.5 通讯

BYPASS通过CAN与PCS进行通信。下图为控制板接口示意图。

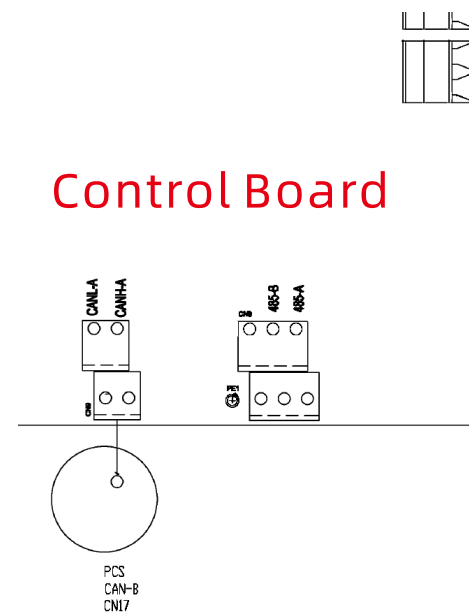

控制板接口示意图

5.6 系统接线

BYPASS为定制机型，项目需求不同，平台搭建存在差异。为避免误导客户搭建系统，不在说明书上做详细说明。具体图纸另外提供，或在项目需要搭建系统时向ATESS的销售或售后人员索取系统图纸。

注意：BYPASS内部所有断路器都带有丝印，接入电网、负载、油机等时必须对应接入，不能接错位置，三相相序也不能接错，否则系统将无法正常运行，甚至会损坏机器。

6.1 运行前检查

在BYPASS 投入运行之前，要对其安装进行检查，至少两名工作人员按照下表所列的项目注意检查以确保各项安装的正确性。

机械安装项目检查

- BYPASS 无变形、损坏情况
- BYPASS 底部固定、支撑稳定可靠
- BYPASS 周围有足够的空间
- BYPASS 所处环境的温度、湿度、通风状况符合要求
- 冷却空气流通顺畅
- 柜体密封防护完整可靠

电气安装检查

- BYPASS 接地完整牢固
- 电网电压与BYPASS 额定输出电压相匹配
- 电网连接相序正确，紧固力矩符合要求
- 电缆线号标记正确，清晰
- 绝缘防护罩完整可靠，危险警告标签清晰牢固

其他检查

- 所有无用的导电部分用绝缘扎带扎紧
- 柜体内部没有遗留工具、零件、钻孔产生的导电灰尘或其他异物
- 柜体内部无凝结的潮气或结冰现象

6.2 上电

BYPASS内部断路器除了旁路开关断开以外，其他断路器闭合。BYPASS控制板取电是从PCS上取，闭合电池后，控制板点亮。

7 产品维护

7.1 日常维护

7.1.1 维护和维修



只有当BYPASS 安全断开与外部所有连接时，当确认这些电源不会再接通且至少等待5分钟以上时，才能对BYPASS 执行所有维护和维修操作。

只有熟悉系统操作的专业技术人员才能执行此类操作。

● 断开断路器

断开所有开关，确保BYPASS 不会意外重新接通。使用万用表测试，确保设备已经断开并且无电压。

● 维护和修改

只有获得时代能创能源科技授权的人员才能维护和修改BYPASS，为确保人身安全，请仅使用制造商提供的原厂配件。如果使用非原厂配件，使用出现任何问题，ATSS将不承担相应责任。

● Bypass开关使用方法

如果PCS发生故障无法继续开机运行，需要停机维修，而接在Bypass上的负载需要继续工作时，可使用Bypass开关让负载由电网或者发电机供电不间断工作，维修人员可安全的维修机器。

步骤1：在PCS故障状态下，打开Bypass开关。

步骤2：关断BYPASS上除了旁路开关的其它所有开关。

此时负载直接由电网提供能量，PCS与电网已经没有连接。但是如果检修PCS，必须按照PCS维护手册进行。PCS在断开电网输入后，仍有直流输入，操作不当，会有触电危险。



注意！

1. 下电后，等待5分钟确认安全后再进行维修工作。
2. 使用万用表测量后确保安全再进行拆装等工作。

7.1.2 更换防尘网

在BYPASS 使用过程中应定期清扫顶部积尘，清洗或更换进风口防尘网，更换防尘网过程中，BYPASS 需要断电。

防尘网更换方式：门板上的防尘过滤棉可直接向上抽出清洗和更换。



为了保证BYPASS 工作正常，需要定期对防尘网进行清洗。

7.1.3 定期维护

BYPASS 必须进行定期的维护工作，以保证其正常运转与使用寿命。

推荐的例行维护周期及工作内容如表7-2所示。

维护项目	周期
清洁SCR散热器	每月
检查柜体内部是否有灰尘、潮气或者凝结水汽等	每月
检查电缆连接是否有松动的情况，如果有必要需将螺丝固紧	每月
检查警告标签，如果有必要及时增加或更换	每月
人工检查交流断路器	每月
检查机器运行过程中是否有异常响声	每周

表7-2 例行维护周期机工作内容



BYPASS的维护操作必须保证在BYPASS的所有断路器断开的情况下进行。BYPASS断路器断开后，某些器件仍带有残余电压，请等待至少五分钟，确认安全后才对BYPASS进行维护，以防触电。

7.2 废旧处理

BYPASS 不会对环境造成污染，产品的组成材料和部件均满足环保要求，时代能创能源科技依据环境保护要求，用户在BYPASS 使用期终结时，应按当地相应法规进行处理。

8 附件

8.1 产品规格

规格参数	BYPASS100	BYPASS250	BYPASS500	BYPASS630	BYPASS1MW
额定电压	400V	400V	400V	400V	400V
额定电流	144A	360A	722A	910A	1444A
额定频率	50HZ/60HZ	50HZ/60HZ	50HZ/60HZ	50HZ/60HZ	50HZ/60HZ
额定功率	100KW	250KW	500KW	630KW	1000KW
最大电流	175A	435A	866A	1091A	1732A
并离网切换时间	自动≤10ms	自动≤10ms	自动≤10ms	自动≤10ms	自动≤10ms
防护等级	IP20	IP20	IP20	IP20	IP20
湿度	0%-95%	0%-95%	0%-95%	0%-95%	0%-95%
环境温度	-25°C-55°C	-25°C-55°C	-25°C-55°C	-25°C-55°C	-25°C-55°C
尺寸 (宽深高)mm	700*500*1630	700*500*1800	1600*800*1900	1600*800*1900	2850*800*2100
重量KG	135	205	900	1040	1500
通讯端口	CANA/485	CANA/485	CANA/485	CANA/485	CANA/485
PCS断路器	250A	630A	1250A	1250A	2000A
旁路开关	250A	630A	1250A	1250A	1600A
光伏断路器 (选配)	250A	630A	1250A	1250A	2000A
负载断路器	250A	630A	1250A	1250A	2000A
电网断路器 (选配)	250A	630A	1250A	1250A	2000A
油机断路器 (选配)	250A	630A	1250A	1250A	2000A

8.2 ATESS工厂保修

● 质保期

本产品质保期为三年，如果合同另有规定，以合同为准。时代能创能源科技产品在质保期内，维修时客户应主动向时代能创能源科技公司服务人员出示购买产品的发票和日期。同时产品上的铭牌标识应清晰可见，否则有权不予维修。

● 质保条件

质保期间出现故障的产品，时代能创能源科技公司将免费维修或者更换产品；更换后的故障机器应归时代能创能源科技公司所有；客户应给时代能创能源科技公司预留一定时间去维修故障机器。

● 责任豁免

以下情况出现，本公司有权不进行质量保证：

无时代能创能源科技标识的产品；

产品或部件已经超过时代能创能源科技保修期；

未按说明书要求，非产品所规定的工作环境或错误安装、保管及使用等造成的故障或损坏（例如温度过高、过低，过于潮湿或干燥，海拔过高，电压或电流不稳定等）；由非时代能创能源科技各售后服务人员安装、修理、更改或拆卸而造成的故障或损坏；

由时代能创能源科技售后委托的除外；

因使用非时代能创能源科技部件导致的故障或损坏；

因意外或人为原因（操作失误、划伤、搬运、磕碰、接入不合适的电压等）导致的故障或损坏，运输损坏；

因自然灾害等不可抗力（如地震、雷击、火灾等）原因造成的故障或损坏；

其他并非时代能创能源科技机器（包括部件）本身质量问题而导致的故障或损坏。

Contents

1 About this Manual

- 1.1 Contents
- 1.2 Target readers
- 1.3 How to use this manual

2 Safety Instructions

- 2.1 Symbols explanation
- 2.2 Notice for use
- 2.3 Installation
- 2.4 Operation personnel
- 2.5 Important note

3 Product Description

- 3.1 BYPASS
- 3.2 Circuit diagram of BYPASS
- 3.3 Layout of the main components
- 3.4 Product information

4 Transportation and storage

- 4.1 Transportation
- 4.2 Inspection and storage

5 Products Installation

- 5.1 Installation condition and requirements
- 5.2 Tools and spare parts required for whole machine installation
- 5.3 Mechanical installation
- 5.4 Electrical installation
- 5.5 Communication
- 5.6 System wiring

6 Pilot operation

- 6.1 Inspection
- 6.2 Commissioning

7 Routine Maintenance

- 7.1 Regular maintenance
- 7.2 Waste disposal

8 Appendix

- 8.1 Specification
- 8.2 ATESS Factory warranty

1 About this Manual

This chapter describes the contents of this manual, target reader, and safety symbols, can help users to have a better understanding of the manual.

1.1 Contents

This manual applies to ATESS BYPASS, it contains:

- **Safety instruction**

Attention that needs to be paid when operating and maintaining ATESS BYPASS model.

- **Product description**

Function, structure, principle and package information of the ATESS BYPASS model.

- **Transportation and storage**

The mode of transportation of the product and the related storage precautions notice.

- **Installation**

Bypass installation conditions, tools, mechanical and electrical installation, the communication connection etc..

- **Commissioning**

Inspection before commissioning.

- **Routine maintenance**

Daily maintenance of BYPASS, the replacement of some spare parts and waste disposal instruction.

- **Appendix**

Technical data, warranty policy and contact information etc..

1.2 Target readers

Qualification:

- Only professional electricians or professionally qualified personnel can transport or install this product.
- The operator should be fully familiar with the structure and working principle of the entire BYPASS.
- The operator should be fully familiar with this manual.
- The operator should be fully familiar with the local standards of the project.

1.3. How to use this Manual

Read this manual before installation of the ATESS BYPASS. Store this manual where accessible at all times.







The contents of this manual will be periodically updated or revised if necessary.

2 Safety Instructions

2.1 Symbols explanation

In order to ensure the personal and property safety of the user during installation, or optimally efficient use of this product, symbols are used highlight the information.

The following symbols may be used in this manual, please read carefully, in order to make better use of this manual.

	DANGER DANGER indicates a hazard with a high level of risk which, if not avoided, will result in death or serious injury.
	CAUTION CAUTION indicates there is potential risk, if not avoided, could result in equipment malfunction and property damage.
	Caution, risk of electric shock When battery bank connecting point are exposed, there will be DC voltage in the equipment DC side; and when output breaker is on, there is a potential risk of electric shock.
	Caution, risk of fire hazard Suitable for mounting on concrete or other non-combustible surface only.
	Protective conductor terminal The inverter has to be firmly grounded to ensure the safety of personnel.
	Risk of electric shock, Energy storage timed discharge Electrical shock danger exists in the capacitor; the cover shall be moved at least 5 minutes later after all powers are disconnected.

2.2 Safety instructions

Bypass installation and service personnel must be trained and familiar with the general safety requirement when working on electrical equipment. Installation and service personnel should also be familiar with the local laws and regulations and safety requirements.

- Read this manual carefully before operation. The equipment will not be under warranty if failing to operate according to this manual.
- Operation on BYPASS must be for qualified electrical technician only.
- All electrical operation must comply with local electrical operation standards.

2.3 Installation

Proper installation requires following all the instructions in the user manual involving transportation, mounting, wiring and commissioning. ATESS does not cover warranty for BYPASS damage due to failing to use it properly.

The protection level of BYPASS is IP20, which is designed for indoor installation.

Please refer to chapter 5 for installation instruction.

Other notice for using BYPASS:

- Pay attention to the safety instructions listed here and below.
- Pay attention to the user manual of energy storage controller.

2.4 Operator

Bypass installation and service personnel must be trained and familiar with the general safety requirement when working on electrical equipment. Installation and service personnel should also be familiar with the local laws and regulations and safety requirements.

2.5 Important note



Item 1: Static electricity can cause damage to BYPASS electrostatic discharge may cause unrecoverable damage to BYPASS internal components!

When operating BYPASS, operator must comply with anti-static protection norms!

Item 2: Restriction

BYPASS cannot be directly used to connect the life support equipment and medical equipment!

Item 3: Precautions

Make sure installation tools or other unnecessary items are not left inside the BYPASS before starting up.

Item 4: Maintenance notice

Maintenance can only be carried out after BYPASS totally discharged.

3 Product Description

3.1 BYPASS

ATESS BYPASS model is designed to work ATESS PCS500. Its main function is: 1. To make PCS realize off-grid fast switching, to ensure uninterrupted supply for load. 2. To allow PCS be able to connected to power grid and generator at the same time. 3. To allow the system be able to used with PV inverter(it needs to confirm with our engineer whether the inverter is compatible with ATESS PCS system).

3.2 Circuit diagram of the BYPASS

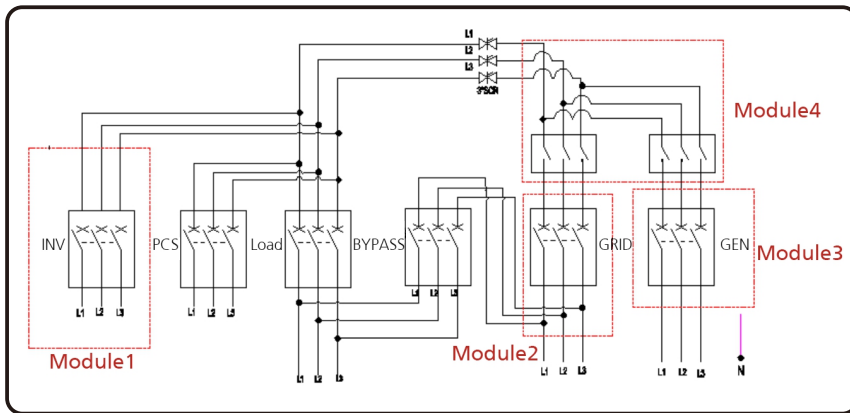

Module 1	PV input	This module can realize the access function of PV inverter, only the inverter produced by ATESS is recommended. Confirm with R & Din advance if other inverters are selected on whether the PV inverter can be connected.
Module 2	Grid input	The module is connected to realize the on/off grid switching function between PCS and grid.
Module 3	DG input	The module is connected to realize the on/off grid switching function between PCS and DG.
Module 4	To realize connection of DG and grid	This module is only needed when connecting DG and grid at the same time, the module won't be consisted if the system is connected to either one.

3.3 The layout of the main components

3.3.1 External components

The external components of BYPASS contain only indicators.

Indicator

BYPASS adopts intelligent design. The current power status of it can be known through three indicator lights on the door panel. Only when the system is connected with DG and grid simultaneously are there three indicators.



LED	Description
PCS	The indicator lights up when there is power on the AC side of PCS and it can supply power to the load normally.
Grid	The indicator lights up when there is power on grid side
GEN	The indicator lights up when there is power on DG side

3.3.2 internal component

The internal devices of BYPASS include PCS circuit breaker, PV circuit breaker, power grid circuit breaker, maintenance switch, DG circuit breaker, load circuit breaker, thyristor, power supply micro break and PCB board.

Note: BYPASS is a function cabinet customized according to customers' needs. There are different requirements and internal devices, The figure below shows the front layout of the BYPASS500 with full function (different models have different layouts).

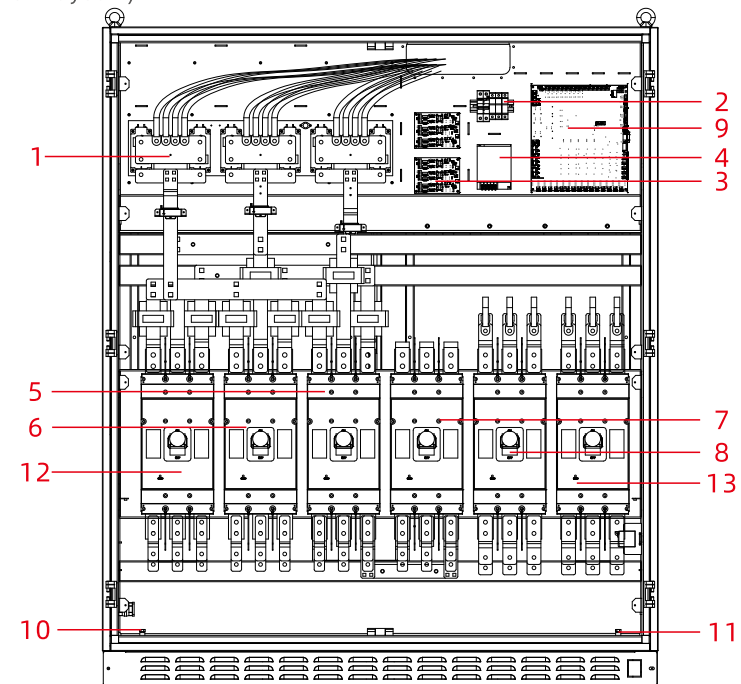

The front structure drawing of BYPASS

Transportation and Storage 4

No.	Item name	Description
1	Thyristor	On/off grid switch
2	Power supply micro break	Control connection of control board power
3	Driving board	Drive circuit board of thyristor
4	Mingwei power supply	Supply power to control board
5	Load breaker	Control connection with load
6	PCS breaker	Control connection with PCS
7	Maintenance breaker	Maintenance switch
8	Grid breaker	Control connection with grid
9	Control board	Control logic of BYPASS and communication with PCS
10	N bar	Load, grid n-wire terminal
11	Ground bar	Machine grounding copper bar
12	Inverter breaker	Control connection with PV inverter
13	Ground breaker	Control connection with DG

3.4 Product information

3.4.1 Dimension and weight

Model	Dimension(W*D*H/mm)	Gross weight(KG)
BYPASS100	W700*D500*H1630	135
BYPASS250	W700*D500*H1800	205
BYPASS500	W1600*D800*H1900	900
BYPASS630	W1600*D800*H1900	1040
BYPASS1000	W2850*D800*H2100	1500

Figure- Dimension and weight of BYPASS

Note: the BYPASS cabinet is customized according to the needs of the project. The actual size and weight deviate from the above table. The actual accurate data can be provided by our sales department.

3.4.2 Packing information

NO.	Name	Unit	Qty.	Note
1	BYPASS	unit	1	Key included
2	User manual	pcs	1	
3	Certificate	pcs	1	
4	Factory test report	pcs	1	

Figure- Packing information

4.1 Transportation

Transportation should follow the transportation methods described in the user manual. BYPASS's weight and center of gravity should be taken into account during transportation. The center of gravity is marked on the box.



Caution, risk of danger

During transportation, lifting equipment and personnel must be qualified. Bypass should be placed vertically and the inclination cannot be more than 10 degrees. It is not allowed to place BYPASS upside down or transport in a horizontal position. Incorrect lifting and transportation can lead to serious injury, property loss and damage to BYPASS.

4.2 Inspection and storage

Bypass should be carefully checked before signing the document from the transportation company. Check the received items against delivery note, and if there is any defect or damage, immediately notify the transportation company. If necessary, you can seek help from ATESS Customer Service department.



Caution

ATESS BYPASS50 can only be stored when it is stopped and all the doors are closed in a dry room to protect the internal circuits against dust and moisture.

5 Installation

5.1 Installation condition requirements

To ensure normal operation of the machine, the installation environment is required as follows:

- The ingress protection of BYPASS is IP20. Moreover, as this product is an electrical equipment, it shall not be placed in humid environment.
- Install indoors and avoid sunlight and rain.
- Ventilation of the room shall be good.
- The installation environment shall be clean.
- As some noise will be produced in operation, this equipment shall be installed far from residential quarters.
- The installation ground shall be even enough, and firm enough to support the weight of BYPASS.
- The installation position shall be convenient for maintenance.
- Ambient temperature range: -25°C~55°C.
- Appropriate space shall be reserved for the machine to ensure ventilation and cooling.

We suggest BYPASS is installed in the distribution room. The floor, wall clearance, Ventilation equipment and precaution should be designed by professional personnel and satisfy the following requirements.

● Foundation requirement

Bypass is required to install on even ground with fire-retardant material as the surface or channel steel support structure, and sag or tilt ground is prohibited. The foundation shall be solid, safe and reliable. The foundation shall be capable of bearing the load of BYPASS. Its load bearing ability shall be concerned throughout the installation place selection.

● Clearance space

During installation of BYPASS, appropriate space shall be left to the wall or other equipment, in order to satisfy the requirements on narrowest maintenance channel, emergency access and ventilation.

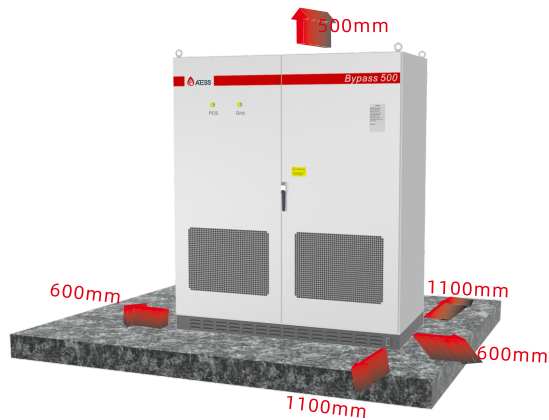

In front of the installation place of BYPASS, a space of 1.5m or more shall be ensured, the back 0.6m or more, the top 0.6m or more to ensure easy installation, cooling and maintenance.

● Cable trench

The cable connection of BYPASS adopts bottom inlet and bottom outlet. Cable trenches are recommended to ensure easy installation and maintenance.

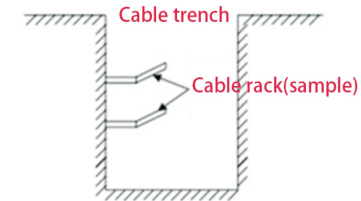

The cable trenches are often designed and constructed by the construction side based on relevant standards, with the equipment weight and dimensions required to be considered. Good electrical connection is needed between different cable trenches and GND terminals.

● Wiring specification

Cables in BYPASS can be classified into either power cables or data cables. In cabling, the power cable shall be kept far away from, and the cable shall be kept in right angle at cross. The cable shall be as short as possible, and an appropriate distance shall be kept to the power cable.

The power cable and data access shall be placed in different cable trenches respectively to avoid lengthy routing between the power cable and other cables, so as to reduce the electromagnetic interruption caused by sudden change of the output voltage. The distance among the power cable and data access shall be more than 0.2m. When the cables are crossed, the cross angle shall be 90 degrees, while the distance can be reduced appropriately.

● Ventilation requirement

In operation, BYPASS will produce heat. When ambient temperature is too high, the electrical property of the equipment may be affected, the equipment may even be damaged. Therefore, the heat release shall be fully considered in designing the control room to ensure operation of the equipment in high efficiency. In front of the installation place of BYPASS, a space of 1.5m or more shall be ensured, the back 0.6m or more, the top 0.6m or more to ensure easy installation, cooling and maintenance.

● Ventilation environment

To satisfy the ventilation requirement of BYPASS, its installation environment shall meet the following conditions:

- ※ BYPASS shall be prevented from being installed in the place of poor ventilation condition and insufficient air flow;
- ※ The air inlet shall have enough air supplementation.

● Ventilation equipment

To ensure safe and reliable operation of the equipment, the ambient temperature must be within the permission range -25°C~ 55°C, therefore, appropriate ventilation devices must be equipped with to release the heat generated by the equipment. We suggest the ventilation rate is more than 3665m³/h.

1. There must be ventilation equipment inside the distribution room to ensure release of the waste heat generated by BYPASS from the equipment, and allow for maximum ambient environment temperature. This can be realized from installation of exhaust devices.
2. Another fan can be added at the air duct outlet to exhaust the air out and ensure balanced pressure.
3. The direction of the air outlet shall be selected according to the local actual wind direction.
4. Pay attention to the dustproof measures and waterproof design at the air inlet and outlet.
5. If more air ducts are required, its dimensions shall be designed by the professionals according to the air output amount.

Other protections

With IP20 of protection level, BYPASS is appropriate to be installed in dry and clean environment. Meanwhile, water leakage of the house shall be prevented, as it may damage BYPASS. According to EMC requirement and noise level, BYPASS shall be installed in industrial environment.

5.2 Tools and spare parts required for whole machine installation

Tools and spare parts required for installation is as follows:

- Hoisting crane, forklift or fork lift truck (with the capacity for bearing the weight of the BYPASS)
- Torque wrench
- Screwdriver
- Wire stripper
- Terminal crimping machine
- Heat dryer
- Megger and multimeter

5.3 Mechanical installation

5.3.1 Transportation of packaged whole machine

This BYPASS is transported as an integrated unit, and the user can hoist it from the bottom with a forklift, or move it with a hoisting crane or crane.

Note 1: BYPASS is integrated and cannot be dissembled either in transportation or installation. Any fault attributed to modification unauthorized by the ATESS is beyond the quality assurance.

Note 2: In movement, tilt, violent shake or sudden force upon BYPASS shall be prevented, such as sudden down of lifting.





Note 3: Please read carefully the labeled parameters to select an appropriate transportation means and storage place.

We suggest the user make use of forklift to move BYPASS if possible.



Before the inverter is moved to the designated place, we suggest to lay the DC input cable and AC main power supply cable. As these cables are relatively thick, they are hard to be cabled after the inverter is installed.

To keep the equipment in a better protective status, please adopt transportation with package as much as possible, and comply with the labels printed on the package in transportation:

Sign	Indication
	The gravity centre
	Lifting logo
	Face up to prohibit the inverter horizontally, tilted or upside down
	Handle with care, to avoid the transport environment too intense collision friction damage to the BYPASS
	Keep away from moisture

Bypass whose packages are not demolished can be moved with forklift, hoisting crane or crane. In moving, attention shall be paid to the weight painted on the package to ensure enough load capacity of the devices. As the gravity center of the equipment locates at the lower place symmetrical in front and back and left and right, the support point or hoisting point shall be arranged reasonably in transportation.

The forklift transportation is the standard one. The gravity center of the cabinet in transportation should locate between two forks of the forklift. The big-size BYPASS may block driver's sight, and it shall be treated with cooperation of the aid personnel.

5.3.2 Movement and installation of bare machine

● Demolish the package of BYPASS

Please demolish the packaged cabinet of the equipment according to the following procedures:

Procedure 1: Demolish the wood side and roof of the packaged cabinet

Procedure 2: Demolish the out-set package material on the machine

Procedure 3: Demolish the fastening screws between the machine and the pallet

- ① Demolish the front and back cover lids of the pedestal.
- ② Screw off the hold-down nuts at the bottom of the wood pallet.
- ③ Remove the screws, and BYPASS will depart from the wood pallet.

● Movement and installation of bear machine

BYPASS with demolished package can be moved with forklift, hoisting crane, slide rail or crane. If the package demolished place is far from the final installation place, it can be transported with forklift containing wood pallet.

If the wooden pallet at the bottom of the machine has been removed, when using the forklift, the front and rear cover plates of the base need to be removed first, and the center of gravity should be placed in the middle of the two forklifts, and then start lifting and transporting, as shown in the following figure:



Caution, risk of danger

We must act slowly and gently when transporting BYPASS with forklift to avoid violent vibration of BYPASS or collision with other objects.

If lifting method is used for moving, please pay attention to the lifting position, ensure that the lifting angle is 70°, and be cautious of the center of gravity position of BYPASS.

NOTE:

- It is necessary to always pay attention to the position of the center of gravity of BYPASS.
- Take necessary auxiliary measures to ensure the safety of transportation personnel.
- Take necessary auxiliary measures to ensure that the equipment is delivered to the final installation site.

5.4 Electrical installation

5.4.1 Input and output requirements



Caution, risk of danger

- There is a danger of electrical shock of high voltage in BYPASS' operation; only electricians of professional skills can operate.
 - All connections with this equipment shall be done under non-voltage state.
 - BYPASS may be damaged if input or output terminal is incorrectly plugged.
- Failure of acting upon this information may cause serious personnel injury or significant property loss even to death.

● **Load**

The total power of load input shall be within the capacity of BYPASS.

● **Three phase grid connection**

Grid required to be connected with the system is three phase grid, and should be in accordance to the previous agreed grid level. Otherwise, damage to the machine due to voltage level problems is not in the scope of warranty.

● **Cable requirements**

1. Please select the corresponding withstand voltage cable according to the voltage level.
2. The current will change due to different voltage value. Please calculate the corresponding cable diameter according to the actual voltage range. The following table only provides cable requirements for the minimum operating voltage for your reference.

	BYPASS100		BYPASS250		BYPASS500	
	Diameter(mm ²)	Aperture	Diameter(mm ²)	Aperture	Diameter(mm ²)	Aperture
PV input	At least a 75mm ² line each phase	Φ8	At least two 75mm ² line each phase	Φ8	At least three 95mm ² line each phase	Φ10
PCS input	At least a 75mm ² line each phase	Φ8	At least two 75mm ² line each phase	Φ8	At least three 95mm ² line each phase	Φ10
Load input	At least a 75mm ² line each phase	Φ8	At least two 75mm ² line each phase	Φ8	At least three 95mm ² line each phase	Φ10
Grid input	At least a 75mm ² line each phase	Φ8	At least two 75mm ² line each phase	Φ8	At least three 95mm ² line each phase	Φ10
DG input	At least a 75mm ² line each phase	Φ8	At least two 75mm ² line each phase	Φ8	At least three 95mm ² line each phase	Φ10
N line	At least a 75mm ² line each phase	Φ8	At least two 75mm ² line each phase	Φ8	At least three 95mm ² line each phase	Φ10
PE line	At least 25mm ² line(special yellow green line)	Φ8	At least 35mm ² line(special yellow green line)	Φ8	At least 75mm ² line(special yellow green line)	Φ8
Comm. line	0.75mm ² special twisted pair shielded comm. line		0.75mm ² special twisted pair shielded comm. line		0.75mm ² special twisted pair shielded comm. line	

	BYPASS630		BYPASS1MW	
	Diameter(mm ²)	Aperture	Diameter(mm ²)	Aperture
PV input	At least four 95mm ² line each phase	Φ10	At least five 120mm ² line each phase	Φ10
PCS input	At least four 95mm ² line each phase	Φ10	At least five 120mm ² line each phase	Φ10
Load input	At least four 95mm ² line each phase	Φ10	At least five 120mm ² line each phase	Φ10
Grid input	At least four 95mm ² line each phase	Φ10	At least five 120mm ² line each phase	Φ10
DG input	At least four 95mm ² line each phase	Φ10	At least five 120mm ² line each phase	Φ10
N line	At least four 95mm ² line each phase	Φ10	At least five 120mm ² line each phase	Φ10
PE line	At least 75mm ² line(special yellow green line)	Φ8	At least 95mm ² line(special yellow green line)	Φ8
Comm. line	0.75mm ² special twisted pair shielded comm. line		0.75mm ² special twisted pair shielded comm. line	

The corresponding port to access shall be selected according to the customized function and model, the accessing port is different with different requirements.

5.4.2 Grid side wiring



Caution, risk of danger

When connecting the AC grid, cut off the circuit breaker at the AC side to ensure that the AC wire connecting to terminals has no electricity.

The output voltage of the AC side of BYPASS is 400V, the wiring method of AC side and grid side is as follows:

- 1) Cut off the circuit breaker at grid side, to ensure that the AC wire connecting to terminals has no electricity. Confirm it with a multimeter.
- 2) Ensure that the wiring phase sequence at AC side is in consistent with the phase sequence at grid side.
- 3) Strip the insulation skin off at the end of the cable
- 4) Crimping copper nose

1. Put the exposed copper core of the stripped wire head into the crimping hole of the copper nose.

2. Use the terminal crimper to compress the copper nose of the wiring, and the number of crimping shall be more than two.

5) install the shrink fit sleeve.

1. Select the heat shrinkable sleeve which is more consistent with the cable size, length is about 5cm.

2. The heat shrinkable sleeve shall be sleeved on the copper nose of the wiring to completely cover the wire pressing hole of the copper nose.

3. Use a heat blower to tighten the heat shrink sleeve.

6) Connect "L1" cable to "L1" of AC distribution cabinet, i.e. phase a (U). Select the bolts that match the copper nose.

7) Connect "L2" of AC output to "L2" of AC distribution cabinet, i.e. phase B (V); connect "L3" of AC output to "L3" of AC distribution cabinet, i.e. phase C (W); connect n-line to n wire on BYPASS.

Note:

1. If the photovoltaic access function is selected, the connection steps are the same as those of grid connection steps 1 to 5. Then confirm the photovoltaic output phase sequence and connect it to the photovoltaic access port in turn.

2. If the access function of the oil turbine is selected, the connection steps are the same as those of the grid connection steps 1 to 5, then confirm the output phase sequence of the oil turbine, connect it to the access port of the oil turbine in turn, and connect the n-line to the N-BAR.

3. Load access, the access steps are the same as those of grid access steps 1 to 5, then confirm the phase sequence, connect to the load access port in turn, and connect the load n line to the n-bank.

5.4.3 Earthing

BYPASS must be earthing well for safety; Please make sure of the connection between PE in power distribution cabinet and PE copper in BYPASS good; and make sure the earthing cable more than half of load cable, and earthing resistance is not lower than 4Ω.

All wiring into the channel at the bottom of BYPASS to be all the wiring is completed, the connection port must be sealed with dust cotton, to prevent dust from entering the inside of BYPASS.



Connect several connecting wires on the PE copper bar as some parts inside the energy storage controller need to be grounded, please do not change them without permission, so as to avoid electric shock

5.5 Communication

BYPASS communicates with PCS via CAN. The following figure is the schematic diagram of the control board interface.

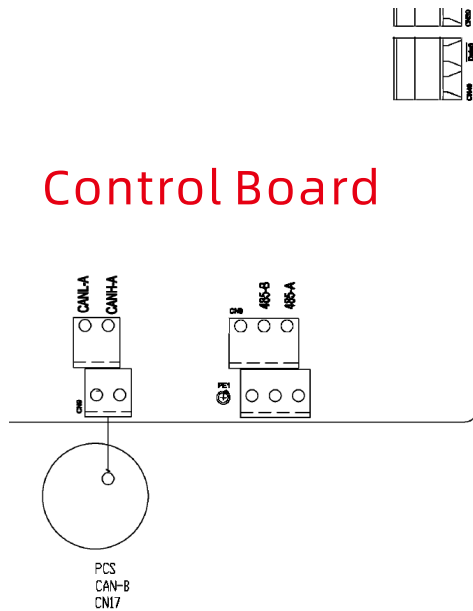

Schematic diagram of the control board interface

5.6 System wiring

BYPASS is a customized model, platform construction differs due to project requirements. In order to avoid misleading customers to build the system, we do not give detailed instructions in the manual. The specific drawings shall be provided separately, or the system drawings shall be obtained from the sales or after-sales personnel of ATESS when the project needs to build a system.

Note: all circuit breakers in BYPASS are with silk screen printing. When connecting to power grid, load, DG etc., they must be connected correspondingly in the right position and the right three-phase phase sequence. Otherwise, the system will not operate normally or even damage the machine.

6.1 Inspection before operation

Before BYPASS is put into operation, its installation shall be inspected. At least two staff do the inspection according to the items listed below to ensure the correctness of the installation.

Inspection items for installation

- There is no deformation or damage to BYPASS.
- Bottom of BYPASS is fixed securely, the foundation support is stable and reliable.
- There is enough space around BYPASS.
- The temperature, humidity and ventilation conditions of the environment where BYPASS is located meet the requirements.
- There is enough cooling air for ventilation.
- Cabinet sealing protection is complete and reliable.

Electrical inspection

- Bypass is grounded completely and firmly.
- The grid voltage matches the rated output voltage of BYPASS.
- The phase sequence of grid connection is correct, and the tightening torque meets the requirements.
- Cable number is marked correctly and clearly.
- The insulation protection cover is complete and reliable, and the danger warning label is clear and firm.

Other inspection

- All useless conductive parts shall be tied with insulating ties.
- There are no tools, parts, conductive dust or other foreign matters left inside the cabinet.
- There is no condensation of moisture or ice in the cabinet.

6.2 Power on steps

All circuit breakers inside BYPASS are closed except the bypass switch is on. The power of BYPASS control board is taken from PCS. After the battery circuit is closed, the control board is powered on.

7 Routine Maintenance

7.1 Regular maintenance

7.1.1 Maintenance and repair

 **Caution!**
All maintenance and repair operations on the BYPASS can only be performed when the BYPASS is safely disconnected from all external connections, and it is confirmed that these power supplies will not be connected again and wait for at least 5 minutes.

Only professional technicians familiar with the system operation can perform such operation.

● Disconnect the circuit breaker

Disconnect all switches to ensure that BYPASS does not accidentally re-connect. Use a multimeter to test, make sure the device is disconnected and voltage free.

● Maintenance and modification

Only personnel authorized by ATESS can maintain and modify BYPASS. To ensure personal safety, please use only the original components provided by the manufacturer. Otherwise ATESS will not be held responsible for any problems in use.

● How to use BYPASS switch

If BYPASS fails and can not continue to operate, it needs to be shut down for maintenance. When the load connected to BYPASS needs to continue to work, the BYPASS switch can be used to power the load continuously by grid or generator, and the maintenance personnel can safely repair the machine.

Step 1: Turn on the PCS switch in case of machine failure.

Step 2: Except bypass switch, turn off all the switches on BYPASS.

At this time, the load is directly supplied by the grid, and PCS is not connected to the grid. However, if the PCS is to be overhauled, it must be carried out in accordance with the PCs maintenance manual. PCs still has DC input after power grid input is disconnected. Improper operation may cause electric shock.

 **Caution!**
1. After power off, wait for 5 minutes to confirm safety before carrying out maintenance work.
2. Use multimeter to measure, ensure the safety before disassembling.

7.1.2 Replace the dust screen

During the use of BYPASS, the dust on the top shall be cleaned regularly, and the dust screen at the air inlet shall be cleaned or replaced. During the replacement of the dust screen, BYPASS shall be powered off.

Replacement method of dust screen: The dust-proof filter cotton on the door panel can be directly pulled up for cleaning and replacement.

 In order to ensure the normal operation of BYPASS, it is necessary to clean the dust screen regularly.

7.1.3 Regular maintenance

In order to ensure the normal operation of BYPASS, regular maintenance work is required. Recommended routine maintenance cycle and work, as shown in Table 7-2.

Maintenance item	Cycle
Clean SCR radiator	every month
Check the dust, moisture or condensation inside the cabinet	every month
Check the cable connections, and fix the screw if necessary	every month
Check the warning label, add or replace some if necessary	every month
Manual inspection on AC and DC circuit breakers	every month
Check if there is abnormal sound when BYPASS is operating	every week

Figure7-2 Routine maintenance work

 **Caution!**
The maintenance operation of BYPASS must be carried out when all circuit breakers of BYPASS are disconnected. After the BYPASS circuit breaker is disconnected, some devices still have residual voltage. Please wait for at least five minutes to confirm safety before maintaining BYPASS to prevent electric shock.

7.2 Waste disposal

Bypass will not cause environmental pollution, since the all the components meet the requirements of environmental protection. According to environmental protection requirements, user shall dispose BYPASS in accordance with the relevant laws and regulations.

8 Appendix

8.1 Specification

Specification	BYPASS100	BYPASS250	BYPASS500	BYPASS630	BYPASS1MW
Rated voltage	400V	400V	400V	400V	400V
Rated current	144A	360A	722A	910A	1444A
Rated frequency	50HZ/60HZ	50HZ/60HZ	50HZ/60HZ	50HZ/60HZ	50HZ/60HZ
Rated power	100KW	250KW	500KW	630KW	1000KW
Maximum current	175A	435A	866A	1091A	1732A
Switch time	Auto≤10ms	Auto≤10ms	Auto≤10ms	Auto≤10ms	Auto≤10ms
Protection degree	IP20	IP20	IP20	IP20	IP20
Humidity	0%-95%	0%-95%	0%-95%	0%-95%	0%-95%
Ambient temperature	-25°C-55°C	-25°C-55°C	-25°C-55°C	-25°C-55°C	-25°C-55°C
Dimensions (W*D*H/mm)	700*500*1630	700*500*1800	1600*800*1900	1600*800*1900	2850*800*2100
Weight(kg)	135	205	900	1040	1500
Comm. interface	CANA/485	CANA/485	CANA/485	CANA/485	CANA/485
PCS breaker	250A	630A	1250A	1250A	2000A
Bypass breaker	250A	630A	1250A	1250A	1600A
Bypass breaker	250A	630A	1250A	1250A	2000A
Load breaker	250A	630A	1250A	1250A	2000A
Grid breaker (optional)	250A	630A	1250A	1250A	2000A
DC breaker (optional)	250A	630A	1250A	1250A	2000A

8.2 ATESS Factory warranty

● Warranty period

The warranty period of this product is 5 years. If otherwise specified in the contract, the contract shall prevail.

During the warranty period, the customer shall show the invoice and date of purchase to the service personnel of ATESS. At the same time, the nameplate mark on the product shall be clear and visible, otherwise, ATESS has the right not to provide warranty service.

● Warranty conditions

In the event of failure during the warranty period, ATESS will repair or replace the product free of charge; The failed machine shall be owned by ATESS; the customer shall Set aside some time to repair the faulty machine.

● Liability exemption

In case of the following circumstances, ATESS has the right not to conduct warranty:

Products without logo of ATESS Power Technology logo.

The product or component that has exceeded the valid warranty period of ATESS.

Failure or damage (such as high temperature, low temperature, too wet or dry, high altitude, unstable voltage or current, etc.) caused by working in beyond-specified environment or wrong installation, storage or use that violates the instructions.

Failure or damage caused by unauthorized installation, repair, modification or disassembly.

Except for those authorized by the after-sales center of ATESS.

Failure or damage caused by using components that not supplied by ATESS.

Failure, damage or transportation damage caused by accident or human factors (operation error, scratching, carrying, bumping, improper voltage connection etc.).

Failure or damage caused by force majeure (such as earthquake, lightning, fire etc.).

Failures or damages caused by other factors rather than quality problems of the supplied product itself(including components).