



# Product Brochure

American Standard  
V2.0 2024.11

Shenzhen ATESS Power Technology Co., Ltd  
GROWATT-ATESS Industrial Park, No.23 Zhulongtian Road, Shuitian Community,  
Shiyan Street, Bao'an District, Shenzhen

Tel: +86 755 2998 8492 Fax: +86 755 2998 5623  
Email: info@atesspower.com Web: www.atesspower.com



# About us

## We are committed to energizing the future with clean energy

Shenzhen ATESS Power Technology Co., Ltd. is a subsidiary of Growatt group, headquartered in GROWATT-ATESS Industrial Park, Shuitian 4th Industrial Zone, Bao'an District, Shenzhen. The park covers an area of 31,600 m<sup>2</sup> and the manufacturing center covers an area of 25,000 m<sup>2</sup>. It is a comprehensive smart industrial park integrating R&D, manufacturing, and sales of new energy products.



ESS & EV charging solutions supplier



31,600 m<sup>2</sup> industrial park



Thousands of tonnes of CO<sub>2</sub> emission reduced



Clean power delivered to 100,000+ users



12 years experience in ESS



200,000+ EV chargers installed



2015  
Started EV charger business

2013  
Started ESS business

2016  
Started EV  
part business

2018  
Top 3 supplier in the Thailand  
ESS market

2019  
Top 3 EV charger supplier  
in the UK market

2020  
Approved as a specialized and  
sophisticated enterprise producing new  
and unique products

2022  
No.1 in the C&I ESS  
sector in South Africa

# Our History

# Our R&D team

ATESS boasts an R&D team of over 100 highly experienced engineers. Our laboratory is fully equipped with advanced testing instruments to ensure top-notch product performance and quality, as well as customers' needs. We dedicate around 15% of our annual revenue to research and development each year to keep our products competitive.

**100+**

100+ R&D engineers

---

**12**

12 years experience

---

**50%+**

50%+ engineers with master's degree

---

**15%**

15% of annual revenue as R&D investment



# Branches



## Our vision

Over the past years, ATESS has helped thousands of users and companies produce and consume green energy independently according to their individual needs, saving millions of tonnes of CO<sub>2</sub> emission. This motivates us to continually strive to create and innovate, on the universal carbon neutralization goal, and also a greener future energized by renewable energy technology.

- 📍 Headquarter
- Office/warehouse
- In the pipeline

**85+**  
Countries

Delivered clean power to 85+ Countries

**13**  
Branches

13 Offices and warehouses Worldwide

**5**  
Years

Systems operating 5+ years

# Index

## Hybrid Inverter

Page 11



ATS50/100/150-US-220  
ATS50/150-US-480



HPS30000TL-US-208

## Battery Inverter Solar Charge Controller

Page 21



PCS100/250/500-US-480  
PCS630/1000-US-480

RTF300/600-US-480



Bypass100/250/500/630/1000-US-480



PBD250

## Accessories

Page 29

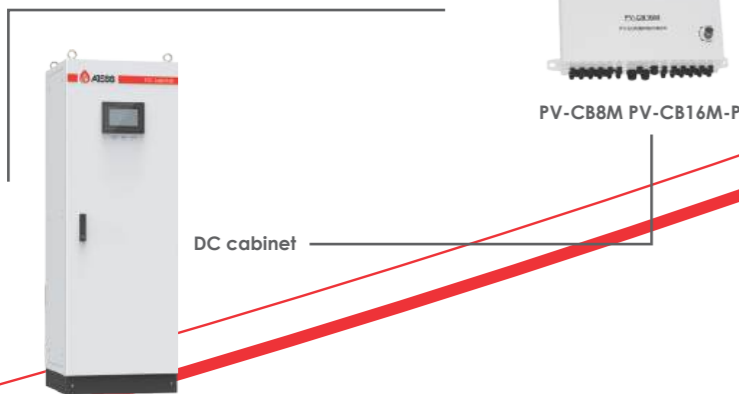

DC cabinet



PV-CB8M PV-CB16M-P

## Battery Solutions

Page 33

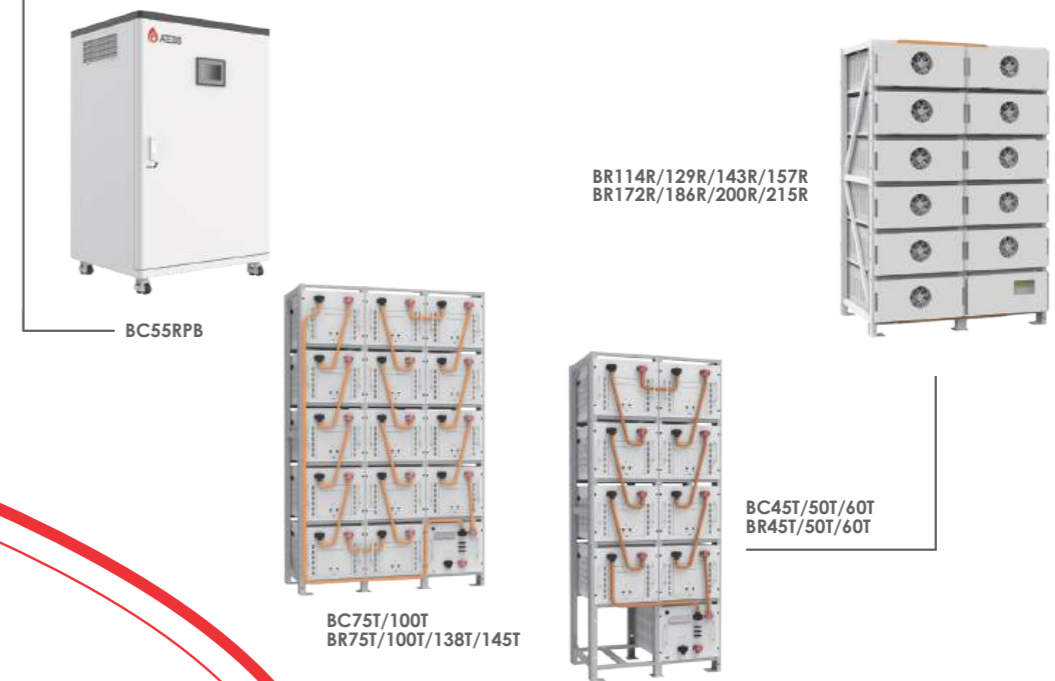

BC55RPB

BC75T/100T  
BR75T/100T/138T/145T

BC45T/50T/60T  
BR45T/50T/60T

BR114R/129R/143R/157R  
BR172R/186R/200R/215R

## Monitoring

Page 43



EnerLog

EnerLog

EnerClo

EnerView

## EV Charging Solutions

Page 49

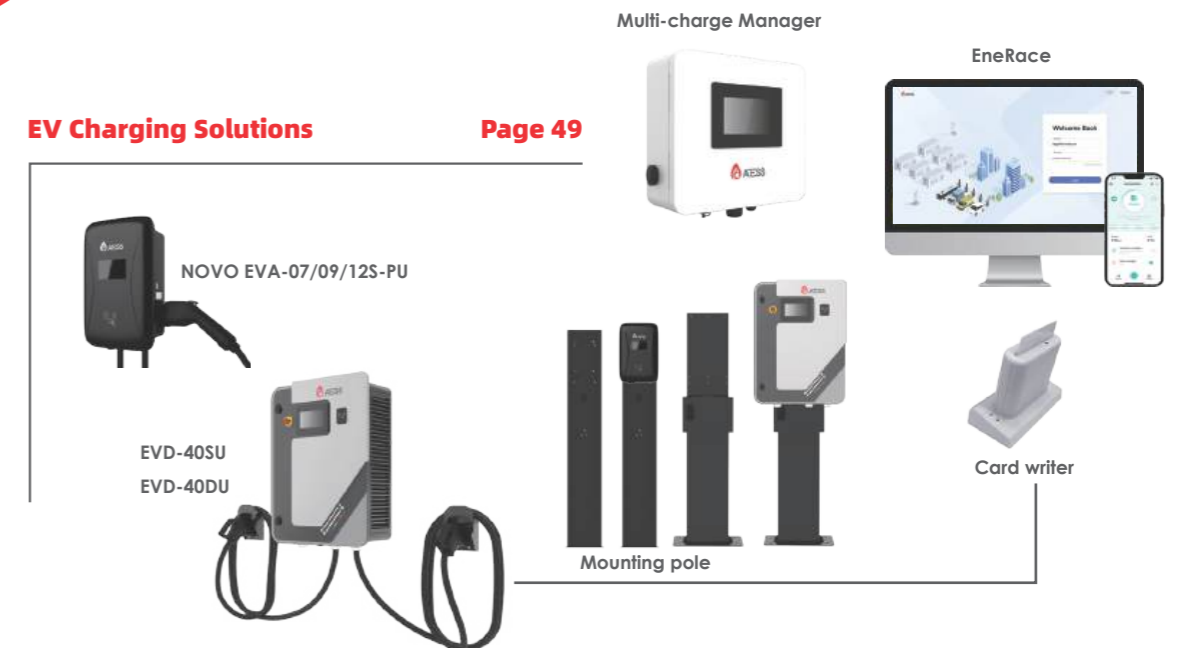

NOVO EVA-07/09/12S-PU

EVD-40SU  
EVD-40DU

Multi-charge Manager

Mounting pole

Card writer

EneRace

# HPS50/100/150-US-220Y(D)

Large capacity all-in-one hybrid inverter for commercial application, supporting up to 600kW system capacity, complied with American standard.

## Features

- All-in-one hybrid inverter
- Seamless on/off grid transfer within 10 ms
- Programmable working mode
- Support remote control of DG
- Touchscreen LCD
- Quadruple capacity by paralleling 4 units



## Block Diagram

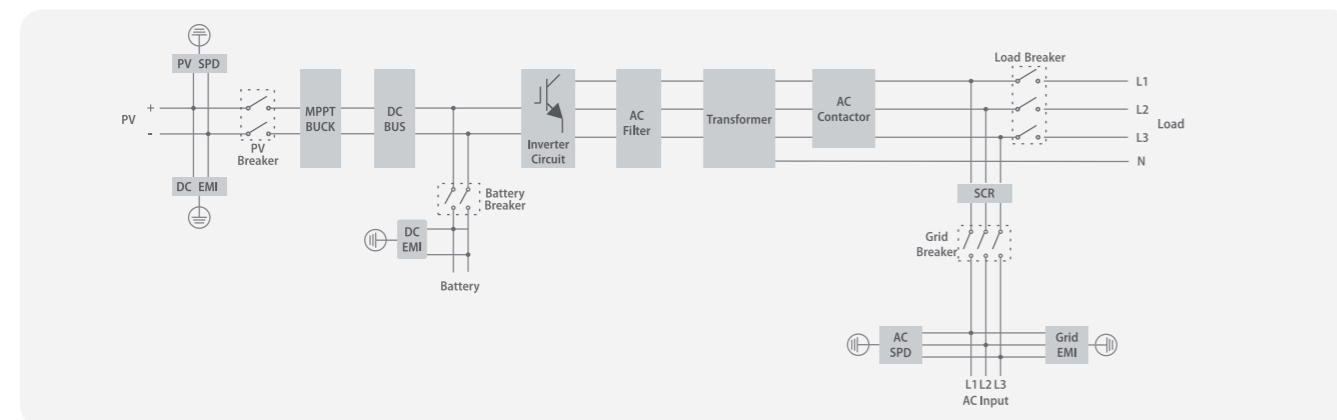

	HPS50-US	HPS100-US	HPS150-US
<b>AC(on-grid)</b>			
Apparent power	50kVA	100kVA	150kVA
Rated power	50kW	100kW	150kW
Rated voltage	220V Wye	220V Wye	220V Wye
Rated current	131A	263A	394A
Voltage range	190-240V	190-240V	190-240V
Rated frequency	50/60Hz	50/60Hz	50/60Hz
Frequency range	45-55/55-65Hz	45-55/55-65Hz	45-55/55-65Hz
THDI	<3%	<3%	<3%
PF	0.8 lagging~0.8 leading	0.8 lagging~0.8 leading	0.8 lagging~0.8 leading
AC input connection	3/N/PE Wye / 3/N/PE Delta(Opt)	3/N/PE Wye / 3/N/PE Delta(Opt)	3/N/PE Wye / 3/N/PE Delta(Opt)
AC input	50kVA	100kVA	150kVA

<b>AC(off-grid)</b>			
Apparent power	50kVA	100kVA	150kVA
Rated power	50kW	100kW	150kW
Rated voltage	220V Wye	220V Wye	220V Wye
Rated current	131A	263A	394A
THDU	≤2% linear	≤2% linear	≤2% linear
Rated frequency	50/60Hz	50/60Hz	50/60Hz
Overload capability	110%-10 mins 120%-1 min	110%-10 mins 120%-1 min	110%-10 mins 120%-1 min

<b>DC (Battery and PV)</b>			
Max. PV open-circuit voltage	1000V DC	1000V DC	1000V DC
Max. PV power	55kWp	110kWp	165kWp
PV MPPT voltage range	480V-800V DC	480V-800V DC	480V-800V DC
Battery voltage range	400V-600V	400V-600V	400V-600V
Max. charge power	75kW	150kW	225kW
Max. discharge power	50kW	100kW	150kW
Max. charge current	125A	250A	319A
Max. discharge current	138A	275A	319A

<b>General Information</b>			
Protection degree	Type 1	Type 1	Type 1
Noise emission	<65dB(A)@1m	<65dB(A)@1m	<65dB(A)@1m
Operating temperature	-25 °C~+55 °C	-25 °C~+55 °C	-25 °C~+55 °C
Cooling method	Forced-air	Forced-air	Forced-air
Relative humidity	0-95% non-condensing	0-95% non-condensing	0-95% non-condensing
Max. altitude	6000m (derate over 3000m)	6000m (derate over 3000m)	6000m (derate over 3000m)
Dimension (W/H/D)	950/1860/750mm	1200/1900/800mm	1200/1900/800mm
Weight	590kg	923kg	1200kg
Build-in transformer	Yes	Yes	Yes
Lightning protection	Type II	Type II	Type II
Transfer between on/off grid	Automatic≤10ms	Automatic≤10ms	Automatic≤10ms
Standby consumption	<30W	<30W	<30W

<b>Communication</b>			
Display	Touch screen	Touch screen	Touch screen
Communication	RS485/CAN	RS485/CAN	RS485/CAN

<b>Certificate</b>			
UL1741 , CSA-C22.2			

\* The MPPT voltage of PV strings should be 50-200V higher than the Max battery voltage.

\* Support voltage types: 190-240V Wye & 190-240V High-leg Delta with split phase(Opt)  
There will be derating at different voltage levels and standards, as shown below:

Voltage system	Rated power of AC IN&OUT	Voltage system	Rated power of AC IN&OUT
190V Wye	86.50%	190V High-leg Delta	79.30%
208V Wye	94.50%	208V High-leg Delta	86.80%
220V Wye	100%	220V High-leg Delta	91.80%
240V Wye	100%	240V High-leg Delta	100.00%

# ATS50/100/150-US-220

The ATS is an accessory of the American standard HPS. When both the grid and DG need to access the HPS, the ATS will be used to switch between the grid and DG automatically.

## Features

-  HPS compatible
-  Flexible management
-  Transfer automatically between grid and DG
-  Support remote control of DG



	ATS50-US-220	ATS100-US-220	ATS150-US-220
Rated voltage	220V	220V	220V
Rated current	131.3A	262.7A	394.1A
Rated frequency	50/60Hz	50/60Hz	50/60Hz
Max. power	75kVA	150kVA	225kVA
Output breaker	250A	400A	630A
Grid breaker	250A	400A	630A
DG breaker	250A	400A	630A
Lightning protection	Type II	Type II	Type II
Protection degree	Type 1	Type 1	Type 1
Relative humidity	0~95% non-condensing	0~95% non-condensing	0~95% non-condensing
Operating temperature	-25°C~+55°C	-25°C~+55°C	-25°C~+55°C
Dimension (W/H/D)	600/1500/430mm	700/1650/500mm	850/1650/550mm
Weight	82kg	135kg	173kg
Communication	RS485/CAN	RS485/CAN	RS485/CAN

## Block Diagram

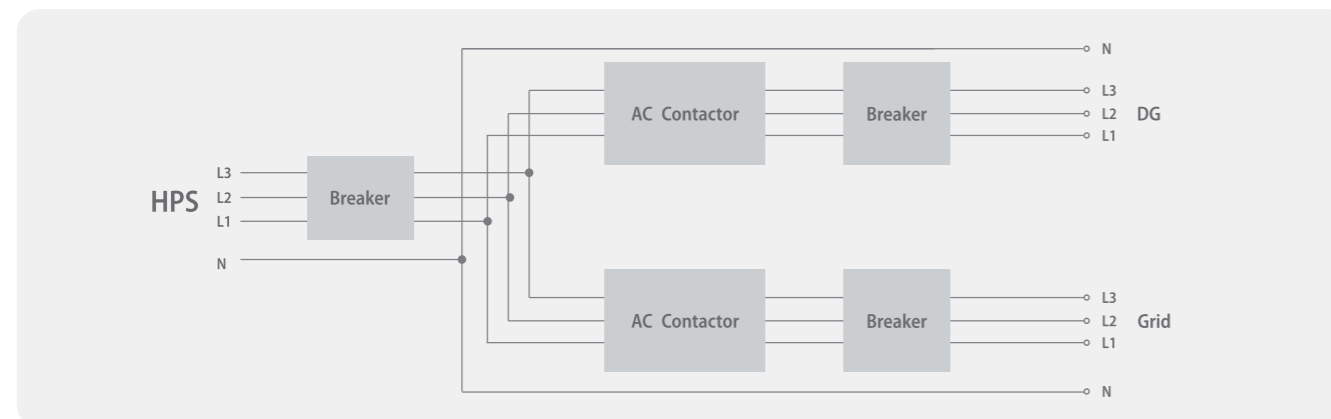



# HPS50/100/150-US-480

Large capacity all-in-one hybrid inverter for commercial application, supporting up to 600kW system capacity, complied with American standard 480V 3P Dyn11.

## Features

-  All-in-one hybrid inverter
-  Seamless on/off grid transfer within 10 ms
-  Programmable working mode
-  Support remote control of DG
-  Touchscreen LCD
-  Quadruple capacity by paralleling 4 units



## Block Diagram

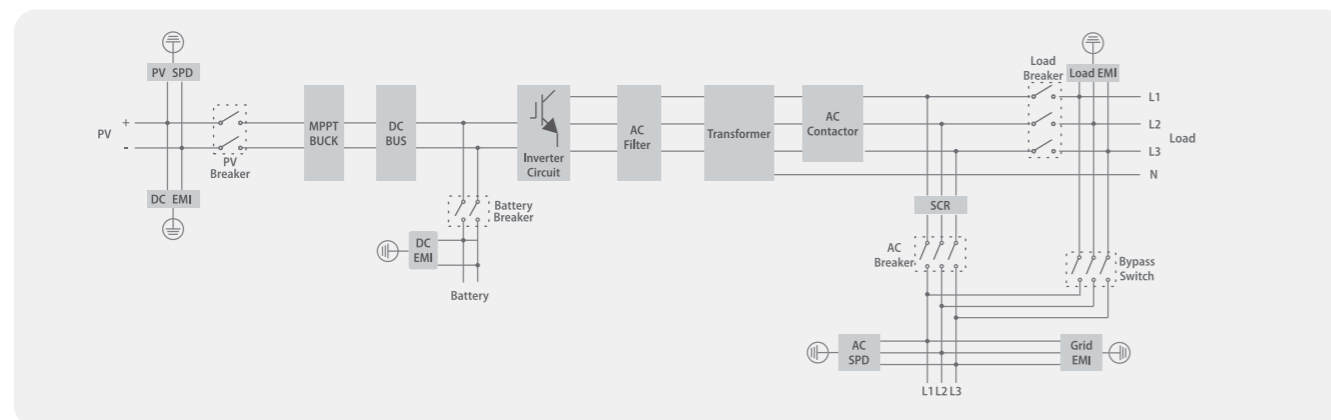

	HPS50-US-480	HPS100-US-480	HPS150-US-480
<b>AC(on-grid)</b>			
Apparent power	50kVA	100kVA	150kVA
Rated power	50kW	100kW	150kW
Rated voltage	480V Wye	480V Wye	480V Wye
Rated current	60A	120A	180A
Voltage range	432-528V	432-528V	432-528V
Rated frequency	50/60Hz	50/60Hz	50/60Hz
Frequency range	45~55/55~65Hz	45~55/55~65Hz	45~55/55~65Hz
THDI	<3%	<3%	<3%
PF	0.8 lagging~0.8 leading	0.8 lagging~0.8 leading	0.8 lagging~0.8 leading
AC connection	3/N/PE Wye	3/N/PE Wye	3/N/PE Wye
AC input	100kVA	200kVA	240kVA

<b>AC(off-grid)</b>			
Apparent power	50kVA	100kVA	150kVA
Rated power	50kW	100kW	150kW
Rated voltage	480V Wye	480V Wye	480V Wye
Rated current	60A	120A	180A
THDU	≤2% linear	≤2% linear	≤2% linear
Rated frequency	50/60Hz	50/60Hz	50/60Hz
Overload capability	110%-10 mins 120%-1 min	110%-10 mins 120%-1 min	110%-10 mins 120%-1 min

<b>DC (Battery and PV)</b>			
Max. PV open-circuit voltage	1000V DC	1000V DC	1000V DC
Max. PV power	75kWp	150kWp	225kWp
PV MPPT voltage range	480V-800V DC	480V-800V DC	480V-800V DC
Battery voltage range	352V-600V	352V-600V	352V-600V
Max. charge power	75kW	150kW	225kW
Max. discharge power	55kW	110kW	165kW
Max. charge current	150A	300A	450A
Max. discharge current	138A	275A	413A

<b>General Information</b>			
Protection degree	Type 1	Type 1	Type 1
Noise emission	<65dB(A)@1m	<65dB(A)@1m	<65dB(A)@1m
Operating temperature	-25 °C~+55 °C	-25 °C~+55 °C	-25 °C~+55 °C
Cooling method	Forced-air	Forced-air	Forced-air
Relative humidity	0-95% non-condensing	0-95% non-condensing	0-95% non-condensing
Max. altitude	6000m (derate over 3000m)	6000m (derate over 3000m)	6000m (derate over 3000m)
Dimension (W/H/D)	950/1860/750mm	1200/1900/800mm	1200/1900/800mm
Weight	590kg	923kg	1200kg
Build-in transformer	Yes	Yes	Yes
Lightning protection	Type II	Type II	Type II
Transfer between on/off grid	Automatic≤10ms	Automatic≤10ms	Automatic≤10ms
Standby consumption	<30W	<30W	<30W

<b>Certificate</b>			
CSA-C22.2			

<b>Communication</b>			
Display	Touch screen	Touch screen	Touch screen
Communication	RS485/CAN	RS485/CAN	RS485/CAN

\* The MPPT voltage of PV strings should be 50~200V higher than the Max battery voltage.

# ATS50/100/150-US-480

The ATS is an accessory of the HPS. When both the grid and DG need to access the HPS, the ATS will be used to switch between the grid and DG automatically.

## Features

-  HPS compatible
-  Flexible management
-  Transfer automatically between grid and DG
-  Support remote control of DG



## Block Diagram

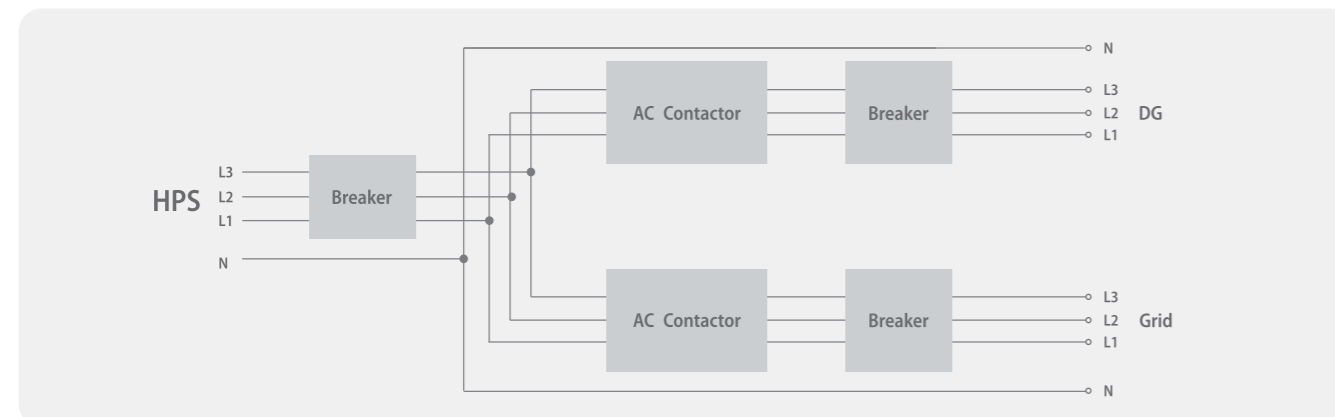

	ATS50-US-480	ATS100-US-480	ATS150-US-480
Rated voltage	480V	480V	480V
Rated current	120A	240A	288A
Rated frequency	50/60Hz	50/60Hz	50/60Hz
Rated power	100kVA	200kVA	240kVA
Output breaker	250A	400A	630A
Grid breaker	250A	400A	630A
DG breaker	250A	400A	630A
Lightning protection	Type II	Type II	Type II
Protection degree	Type 1	Type 1	Type 1
Relative humidity	0~95% non-condensing	0~95% non-condensing	0~95% non-condensing
Operating temperature	-25°C~+55°C	-25°C~+55°C	-25°C~+55°C
Dimension (W/H/D)	600/1500/450mm	700/1650/500mm	700/1650/500mm
Weight	77kg	125kg	125kg
Communication	RS485/CAN	RS485/CAN	RS485/CAN

# HPS30000TL-US-208

30kW three phase all-in-one hybrid inverter for small commercial use.

## Features

-  All-in-one hybrid inverter
-  Compact design
-  Touchscreen LCD
-  Seamless on/off grid transfer within 10 ms
-  Max. 4 units in parallel for on&off grid operation
-  Support remote control of DG
-  Programmable working mode
-  Multiple MPPT inputs



## Block Diagram

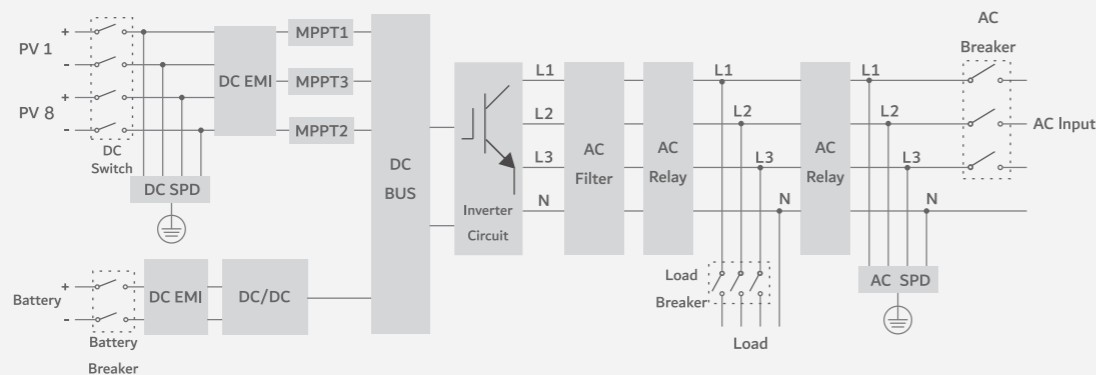

## HPS30000TL-US-208

### AC(on-grid)

Apparent power	30kVA
Rated power	30kW
Rated voltage	208V
Rated current	83A
Voltage range	190-240V Wye/High-leg delta with split phase (Opt) (Derate below 208V 3P)
Rated frequency	50/60Hz
Frequency range	47~53/57~63Hz
THDI	<3%
PF	0.8 lagging~0.8 leading
AC connection	3/N/PE

### AC(off-grid)

Apparent power	30kVA
Rated power	30kW
Rated voltage	208V
Rated current	83A
Voltage range	190-240V Wye/High-leg delta with split phase (Opt) (Derate below 208V 3P)
THDU	≤2% linear
Rated frequency	50/60Hz
Overload capability	110%-10 mins 120%-1 min

### DC (Battery and PV)

Max. PV Open-circuit voltage	800V
Max. PV power	36kWp
PV MPPT voltage range	125V-620V
Number of MPPT	3
PV input/MPPT	2/3/3
PV input current/MPPT	40/60/60A
Max. PV input current	160A
Max. PV Isc/MPPT	60/90/90A
Battery voltage range	260-620V
Full load battery voltage range	300-600V
Max. charge/discharge power	30kW
Max. charge/discharge current	85A

### General Information

Protection devices	PV DC switch, PV fuse, battery breaker and fuse
Protection degree	Type 3R
Noise emission	<65dB(A)@1m
Operating temperature	-30 °C~+50 °C
Cooling method	Forced-air
Relative humidity	0-95% non-condensing
Max. altitude	3000m (derate over 2000m)
Dimension (W/H/D)	600/1000/315mm
Weight	90kg
Topology	Transformerless
Lightning protection	Type II
Transfer between on/off grid	Automatic≤10ms
Standby consumption	<20W

### Communication

Display	Touch screen
Communication	RS485/CAN
Monitoring	WiFi or 4G module available

# PBD250

1000V level DC to DC solar charge controller, used together with ATESS PCS and Bypass for large scale solar projects.

## Features

-  Multiple units parallelable
-  Modular design
-  Up to 5 MPPTs
-  Transformerless design



## PBD250

### Input (PV)

Max. PV power	250kW
MPPT voltage range	350V-850V
Full load MPPT voltage range	480V-850V
Max. input current	575A(115A*5)
Number of MPPT	5

### Output (Battery and PCS)

Output voltage	600V-900V
Max. charge power	250kW
Max. charge current	416A
Max. charge efficiency	99%

### Protection

Input & output OV/UV protection	Yes
Input & output OC protection	Yes
Short circuit protection	Yes
Over temperature protection	Yes
Lightning protection	Type II
DC breaker	Yes
Emergency stop	Yes

### General Information

Protection degree	IP20
Noise emission	<65dB(A)@1m
Operating temperature	-25 °C~+55 °C
Cooling method	Forced-air
Relative humidity	0-95% non-condensing
Max. altitude	6000m (derate over 3000m)
Dimension (W/H/D)	800/1900/700mm
Weight	289kg
Topology	Transformerless
Standby power	<100W

### Communication

Display	Touch screen
Communication	RS485/CAN

### Certificate

CE

# PCS100/250/500-US-480 PCS630/1000-US-480

Bidirectional battery inverter from 100kW to 1000kW, can be used alone or with solar charge controllers and other accessories for different application scenarios.

## Features

- Paralleling multiple units
- Programmable working mode
- Flexible configuration
- Touchscreen LCD
- Support remote control of DG



## Block Diagram

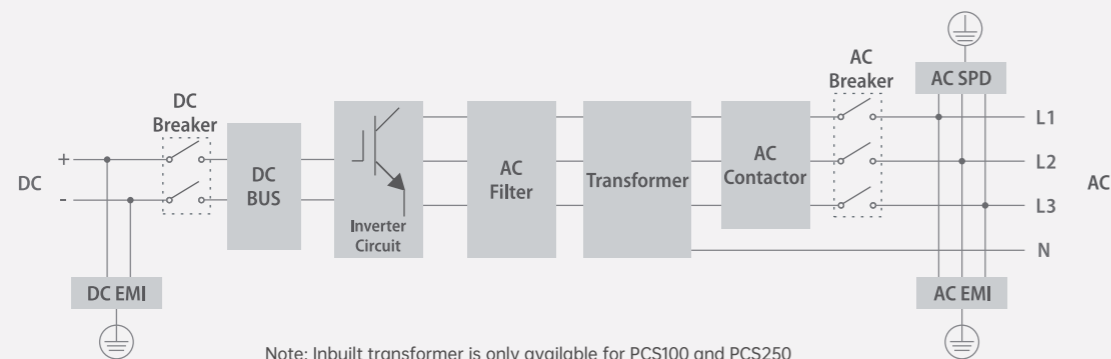

Note: Inbuilt transformer is only available for PCS100 and PCS250

	PCS100-US-480	PCS250-US-480	PCS500-US-480	PCS630-US-480	PCS1000-US-480
<b>AC(on-grid)</b>					
Apparent power	100kVA	250kVA	500kVA	630kVA	1000kVA
Rated power	100kW	250kW	500kW	630kW	1000kW
Rated voltage	480V	480V	480V	480V	480V
Rated current	120A	301A	601A	758A	1203A
Voltage range	432V-528V	432V-528V	432V-528V	432V-528V	432V-528V
Rated frequency	50/60Hz	50/60Hz	50/60Hz	50/60Hz	50/60Hz
Frequency range	45~55/55~65Hz	45~55/55~65Hz	45~55/55~65Hz	45~55/55~65Hz	47~51.5/57~61.5Hz
THDI	<3%	<3%	<3%	<3%	<3%
PF	0.8 lagging~0.8 leading	0.8 lagging~0.8 leading	0.8 lagging~0.8 leading	0.8 lagging~0.8 leading	0.8 lagging~0.8 leading
AC connection	3/N/PE	3/N/PE	3/PE	3/PE	3/PE

	PCS100-US-480	PCS250-US-480	PCS500-US-480	PCS630-US-480	PCS1000-US-480
<b>AC(off-grid)</b>					
Apparent power	100kVA	250kVA	500kVA	630kVA	1000kVA
Rated power	100kW	250kW	500kW	630kW	1000kW
Rated voltage	480V	480V	480V	480V	480V
Rated current	120A	301A	601A	758A	1203A
THDU	≤2% linear	≤2% linear	≤2% linear	≤2% linear	≤2% linear
Rated frequency	50/60Hz	50/60Hz	50/60Hz	50/60Hz	50/60Hz
Overload capability	110%-10 mins 120%-1 min	110%-10 mins 120%-1 min	110%-10 mins 120%-1 min	110%-10 mins 120%-1 min	110%-10 mins 120%-1 min

	PCS100-US-480	PCS250-US-480	PCS500-US-480	PCS630-US-480	PCS1000-US-480
<b>DC (Battery and PV)</b>					
Rated power	100kW	250kW	500kW	630kW	1000kW
Current regulation	±1%	±1%	±1%	±1%	±1%
Voltage regulation	±1%	±1%	±1%	±1%	±1%
Voltage ripple	<3%	<3%	<3%	<3%	<3%
Current ripple	<2%	<2%	<2%	<2%	<2%
Voltage range	500V-820V	500V-820V	600V-900V	650V-900V	700V-900V
Max. charge/discharge current	220A	550A	917A	1155A	1430A

	PCS100-US-480	PCS250-US-480	PCS500-US-480	PCS630-US-480	PCS1000-US-480
<b>General Information</b>					
Max. efficiency	97.10%	97.30%	98.50%	98.50%	99.0%
Protection degree	Type 1	Type 1	Type 1	Type 1	Type 1
Noise emission	<65dB(A)@1m	<65dB(A)@1m	<65dB(A)@1m	<65dB(A)@1m	<65dB(A)@1m
Operating temperature	-25°C~+55°C	-25°C~+55°C	-25°C~+55°C	-25°C~+55°C	-25°C~+55°C
Cooling method	Forced-air	Forced-air	Forced-air	Forced-air	Forced-air
Relative humidity	0-95% non-condensing	0-95% non-condensing	0-95% non-condensing	0-95% non-condensing	0-95% non-condensing
Max. altitude	6000m (derate above 3000m)	6000m (derate above 3000m)	6000m (derate above 3000m)	6000m (derate above 3000m)	6000m (derate over 3000m)
Dimension(W/H/D)	1100/1890/850mm	1600/2080/850mm	1200/1900/800mm	1200/1900/800mm	1510/1900/850mm
Weight	820kg	1465kg	870kg	900kg	1500kg
Build-in transformer	Yes	Yes	No	No	No
Lightning protection	Type II	Type II	Type II	Type II	Type II
Transfer between on/off grid	Manual(default) Automatic(optional) ≤10ms	Manual(default) Automatic(optional) ≤10ms	Manual(default) Automatic(optional) ≤10ms	Manual(default) Automatic(optional) ≤10ms	Manual(default) Automatic(optional) ≤10ms

	PCS100-US-480	PCS250-US-480	PCS500-US-480	PCS630-US-480	PCS1000-US-480
<b>Communication</b>					
Display	Touch screen	Touch screen	Touch screen	Touch screen	Touch screen
Communication	RS485/CAN	RS485/CAN	RS485/CAN	RS485/CAN	RS485/CAN



	PCS100-US-480	PCS250-US-480	PCS500-US-480	PCS630-US-480	PCS1000-US-480
<b>Certificate</b>					
UL1741, CSA-C22.2					

# Bypass100/250/500-US-480

## Bypass630/1000-US-480

ATESS bypass cabinet is designed to be used together with the bidirectional battery inverter to realize seamless transfer between on-grid and off-grid modes automatically.

### Features

-  Import/export control
-  Seamless on/off grid transfer within 10ms
-  Flexible management
-  DG connection supported



### Block Diagram

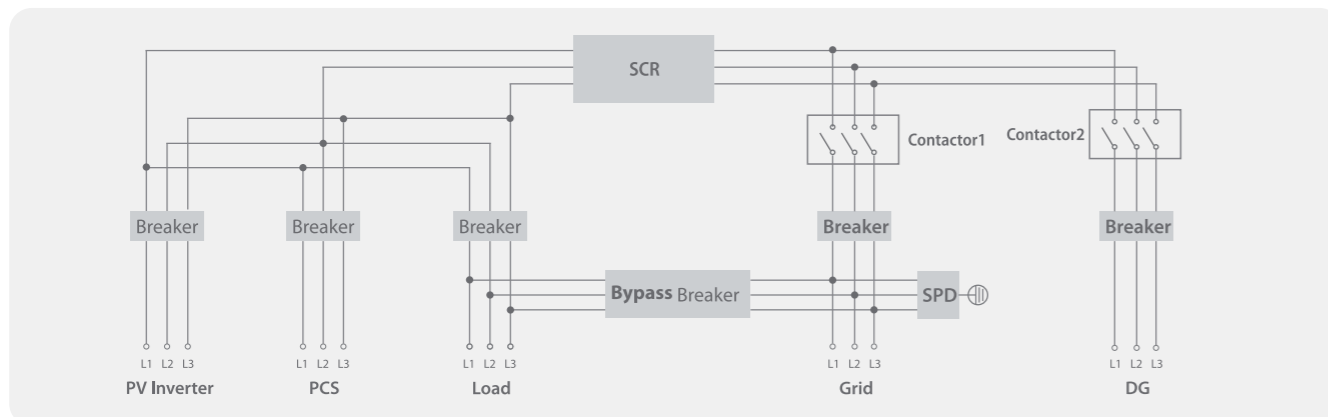

	Bypass100-US-480	Bypass250-US-480	Bypass500-US-480	Bypass630-US-480	Bypass1000-US-480
Rated voltage	480V	480V	480V	480V	480V
Rated current	120A	301A	601A	758A	1202A
Rated frequency	50Hz	50Hz	50Hz	50Hz	50Hz
Rated power	100KVA	250KVA	500KVA	630KVA	1000KVA
Max. current	175A	435A	866A	1091A	1443A
Transfer between on/off grid	Automatic≤10ms	Automatic≤10ms	Automatic≤10ms	Automatic≤10ms	Automatic≤10ms
Zero export function	Opt	Opt	Opt	Opt	Opt
Power limit(grid)	Opt	Opt	Opt	Opt	Opt
PV inverter breaker	250A	630A	1250A	1250A	2000A/3P
PCS breaker	250A	630A	1250A	1250A	2000A/3P
Grid breaker	250A	630A	1250A	1250A	2000A/3P
Load breaker	250A	630A	1250A	1250A	2000A/3P
Bypass breaker	250A	630A	1250A	1250A	1600A/3P
DG breaker	Opt	Opt	Opt	Opt	Opt
Lightning protection	Type II	Type II	Type II	Type II	Type II
Protection degree	Type 1	Type 1	Type 1	Type 1	Type 1
Relative humidity	0-95% non-condensing	0-95% non-condensing	0-95% non-condensing	0-95% non-condensing	0-95% non-condensing
Operating temperature	-25 °C~+55 °C	-25 °C~+55 °C	-25 °C~+55 °C	-25 °C~+55 °C	-25 °C~+55 °C
Dimension (W/H/D)	700/1630/500mm	700/1800/500mm	1600/1900/800mm	1600/1900/800mm	2850/2100/800mm
Weight	135kg	205kg	900kg	1040kg	1500kg
Communication	RS485/CAN	RS485/CAN	RS485/CAN	RS485/CAN	RS485/CAN

# RTF300/600-US-480

Modular rectifier cabinet, 300KW and 600KW optional, can be combined with ATESS PCS to form a DC coupling solution, suitable for large industrial scenarios.



## Features

-  AC-DC converter only
-  Flexible configuration
-  Touchscreen LCD
-  Paralleling multiple units



### RTF300-US-480

### RTF600-US-480

#### AC(on-grid)

Rated power	300kW	600kW
Rated voltage	480V	480V
Rated current	361A	722A
Voltage range	260V-528V	260V-528V
Rated frequency	50±10%	50±10%
PF	≥0.98	≥0.98
THDI	≤5%	≤5%
Efficiency	≥95%	≥95%

#### DC(output)

Voltage range	200Vdc-950Vdc (full above 500V derate below 500V)	200Vdc-950Vdc (full above 500V derate below 500V)
Max. output current	560A	1200A
Output current ripple	≤1%	≤1%
Voltage accuracy	≤0.5%	≤0.5%
Current accuracy	≤1%	≤1%

#### General Information

Nosie emission	≤68Db(A)@1m	≤68Db(A)@1m
Operating temperature	-40 °C~+45 °C, full load; 45 °C~55 °C, half load	-40 °C~+45 °C, full load; 45 °C~55 °C, half load
Storage temperature	-40 °C~85 °C	-40 °C~85 °C
Relative humidity	0~95% non-condensing	0~95% non-condensing
Max. altitude	<2000m	<2000m
Cooling method	Forced-air	Forced-air
Dimension (W/H/D)	1204/1958/853mm	1204/1958/853mm
Weight	245kg	350kg

#### Communication

Display	Touch screen	Touch screen
Communication	RS485/CAN	RS485/CAN





#### Certificate

CE

## DC Cabinet

The DC cabinet is mainly to aggregate and share the current distribution of each battery rack to achieve the charge and discharge management function of each battery rack. The DC cabinet consists of DC circuit breakers, copper bars, MBMS and LCD.

### Features

-  Compact design
-  Touchscreen LCD
-  Inbuilt MBMS
-  Multiple battery racks combination

#### ATESS Batt-Master Cabinet 9R

#### ATESS Batt-Master Cabinet 15R

Range of battery racks connected in parallel	9	15
Rated battery rack current	100A	100A
Max. battery rack current	200A(Opt)	200A(Opt)
Rated charge and discharge current	900A	1500A
Max. charge and discharge current	1800A	3000A
Max. battery voltage	1000V	1000V
MBMS	Inbuilt	Inbuilt
Protection degree	Type 1	Type 1
Dimensions (W/H/D)	600/1760/600mm	800/2000/550mm
Weight	177kg	256kg
Display	7 inch touch screen	7 inch touch screen





# PV-CB8M

# PV-CB16M-P

The PV combiner box is an accessory for multiple PV strings connections, and it is with a smart controller inbuilt for monitoring, along with comprehensive protections including the fuse and SPD.

## Features

-  Lightning protection
-  IP65 environment compatibility
-  RS485 communication interface
-  Monitoring function
-  Flexible design with 8 or 16 optional inputs
-  Input fuse for over current protection



	PV-CB8M	PV-CB16M-P
<b>Input DC</b>		
Max. input voltage	1000V	1000V
Max. string Isc	20A	20A
Number of input string	8	16
Input fuse	1 on negative and positive pole of each string, 25A, 10*38mm	1 on negative and positive pole of each string, 30A, 10*38mm
Input cable gland	4mm-8mm cable diameter	4mm-8mm cable diameter
Input cable terminal	4mm <sup>2</sup> -6mm <sup>2</sup>	4mm <sup>2</sup> -6mm <sup>2</sup>

<b>Output DC</b>		
Number of output	1	1
Max. output current	144A	320A
Output breaker	200A	400A
Output cable terminal	50mm <sup>2</sup>	120mm <sup>2</sup>
Output cable gland	13mm-18mm cable diameter	18mm-25mm cable diameter

<b>General Information</b>		
Dimension (W/H/D)	600/500/172mm	600/500/202mm
Weight	22.5kg	29kg
Enclosure material	Galvanized steel	Galvanized steel
Protection degree	IP65	IP65
Operating temperature	-25°C~55°C	-25°C~55°C
Humidity	0~99%	0~99%
Altitude	2000m without derating	2000m without derating
Lightning protection	Type II	Type II
Cooling method	Natural convection	Natural convection
Mounting	Wall-mount	Wall-mount
Monitoring	String current, bus voltage, breaker status, surge arrester status, internal temperature	String current, bus voltage, breaker status, surge arrester status, internal temperature
Power supply	DC300V~1000V	DC300V~1000V
Power consumption	14W	14W
Communication	RS485	RS485

# BC55RPB

Outdoor battery cabinet with an IP54 protection level, inbuilt lithium-ion batteries, and the BMS.

## Features

-  Flexible modular design
-  Self-developed 3-level BMS
-  Remote monitoring and upgrade
-  Long cycle Life, 6000 cycles  
Note: At specific test condition.
-  Cell balancing method optional
-  Max 1C discharge



## BC55RPB

### Battery module specification

Configuration	16S1P
Rated capacity	100Ah
Rated energy	5.12kWh
Rated voltage	51.2V
Voltage range	44.8-58.4V
Rated charge/discharge	0.5C
Max. charge/discharge	1C
AC internal resistance	≤8mΩ
Dimension (W/H/D)	446.5/165/655mm
Weight	44kg

### Battery rack specification

Configuration	6 battery modules +1 BPU	7 battery modules +1 BPU	8 battery modules +1 BPU	9 battery modules +1 BPU	10 battery modules +1 BPU	11 battery modules +1 BPU
Rated capacity	100Ah	100Ah	100Ah	100Ah	100Ah	100Ah
Rated energy	30.72kWh	35.84kWh	40.96kWh	46.8kWh	51.2kWh	56.3kWh
Rated voltage	307.2V	358.4V	409.6V	468V	512V	563V
Voltage range	268.8V-345.6V	313.6V-403.2V	358.4V-460.8V	403.2V-518.4V	448V-576V	492.8V-642.4V
Rated charge/discharge	0.5C	0.5C	0.5C	0.5C	0.5C	0.5C
Max. charge/discharge	1C	1C	1C	1C	1C	1C
AC internal resistance	≤80mΩ	≤56mΩ	≤64mΩ	≤72mΩ	≤80mΩ	≤88mΩ
Display	7" Touch screen	7" Touch screen	7" Touch screen	7" Touch screen	7" Touch screen	7" Touch screen
BMS	Included	Included	Included	Included	Included	Included
Communication	CAN	CAN	CAN	CAN	CAN	CAN
Monitoring	RS485	RS485	RS485	RS485	RS485	RS485
Max. altitude	3000m	3000m	3000m	3000m	3000m	3000m
Dimension (W/H/D) mm	1052/1627/850mm	1052/1627/850mm	1052/1627/850mm	1052/1627/850mm	1052/1627/850mm	1052/1627/850mm
Weight	474kg	518kg	562kg	606kg	650kg	694kg
Protection degree	IP54	IP54	IP54	IP54	IP54	IP54

### Balancing methods

Passive cell balancing	Yes
Active cell balancing	Opt

### BMS parameters on LCD

Cell voltage	Yes
Cell high voltage	Yes
Battery SOC	Yes
Cell temperature	Yes
Charge and discharge current	Yes
Cell low voltage	Yes
Total battery voltage	Yes
Fault warning	Yes

### Protection

Short circuit protection	Yes
Over current protection	Yes
Over charge protection	Yes
Over temperature protection	Yes
Cell over voltage protection	Yes
Cell under voltage protection	Yes
Over discharge protection	Yes

### Certificate

CE, UL, UN38.3, IEC62619, MSDS, ROHS, CB

\*Note: Active balancing is under development.

# BC45T/50T/60T BR45T/50T/60T

Outdoor battery cabinet with an IP54 protection level, and indoor battery rack with an IP20 protection level, inbuilt lithium-ion batteries, and the BMS.

## Features

-  Flexible modular design
-  Self-developed 3-level BMS
-  Remote monitoring and upgrade
-  Long cycle Life, 6000 cycles
-  Cell balancing method optional
-  0.5C&1C discharge optional

Note: At specific test condition.



### BC45T BR45T

### BC50T BR50T

### BC60T BR60T

#### Battery module specification

Configuration	24S1P	24S1P	24S1P
Rated capacity	100Ah	100Ah	100Ah
Rated energy	7.68kWh	7.68kWh	7.68kWh
Rated voltage	76.8V	76.8V	76.8V
Voltage range	67.2-87.6V	67.2-87.6V	67.2-87.6V
Rated charge/discharge	0.5C	0.5C	0.5C
Rated charge/discharge	1C(Opt)	1C(Opt)	1C(Opt)
AC internal resistance	≤15mΩ	≤15mΩ	≤15mΩ
Dimension (W/H/D)	360/285/692mm	360/285/692mm	360/285/692mm
Weight	≤74kg	≤74kg	≤74kg

#### Battery rack specification

Configuration	6 battery modules +1 BPU		7 battery modules +1 BPU		8 battery modules +1 BPU	
Rated capacity	100Ah		100Ah		100Ah	
Rated energy	46.08kWh		53.76kWh		61.44kWh	
Rated voltage	460.8V		537.6V		614.4V	
Voltage range	403.2V-525.6V		470.4V-613.2V		537.6V-700.8V	
Rated charge/discharge	0.5C		0.5C		0.5C	
Rated charge/discharge	1C(Opt)		1C(Opt)		1C(Opt)	
AC internal resistance	≤90mΩ		≤105mΩ		≤120mΩ	
Display	7" Touch screen		7" Touch screen		7" Touch screen	
BMS	Included		Included		Included	
Communication	CAN		CAN		CAN	
Monitoring	RS485		RS485		RS485	
Max. altitude	3000m		3000m		3000m	
Dimension (W/H/D) mm	950/2150/1025	752/1760/660	950/2150/1025	752/1760/660	950/2150/1025	752/1760/660
Weight	≤716kg	≤539kg	≤792kg	≤615kg	≤868kg	≤691kg
Protection degree	IP54	IP20	IP54	IP20	IP54	IP20

#### Balancing methods

Passive cell balancing	Yes	Yes	Yes
Active cell balancing	Opt	Opt	Opt

#### BMS parameters on LCD

Cell voltage	Yes	Yes	Yes
Cell high voltage	Yes	Yes	Yes
Battery SOC	Yes	Yes	Yes
Cell temperature	Yes	Yes	Yes
Charge and discharge current	Yes	Yes	Yes
Cell low voltage	Yes	Yes	Yes
Total battery voltage	Yes	Yes	Yes
Fault warning	Yes	Yes	Yes

#### Protection

Short circuit protection	Yes	Yes	Yes
Over current protection	Yes	Yes	Yes
Over charge protection	Yes	Yes	Yes
Over temperature protection	Yes	Yes	Yes
Cell over voltage protection	Yes	Yes	Yes
Cell under voltage protection	Yes	Yes	Yes
Over discharge protection	Yes	Yes	Yes

#### Certificate

CE, UL, UN38.3, IEC62619, MSDS, ROHS, CB

# BC75T/100T BR75T/100T/138T/145T

Outdoor battery cabinet with an IP54 protection level, and indoor battery rack with an IP20 protection level, inbuilt lithium-ion batteries, and the BMS.

## Features



Flexible modular design



Self-developed 3-level BMS



Remote monitoring and upgrade



Long cycle Life, 6000 cycles



Cell balancing method optional



0.5C&1C discharge optional

Note: At specific test condition.



	BC75T BR75T	BC100T BR100T	BR138T	BR145T
<b>Battery module specification</b>				
Configuration	12S2P	12S2P	12S2P	12S2P
Rated capacity	200Ah	200Ah	200Ah	200Ah
Rated energy	7.68kWh	7.68kWh	7.68kWh	7.68kWh
Rated voltage	38.4V	38.4V	38.4V	38.4V
Voltage range	33.6~43.8V	33.6~43.8V	33.6~43.8V	33.6~43.8V
Rated charge/discharge	0.5C	0.5C	0.5C	0.5C
Rated charge/discharge	1C(Opt)	1C(Opt)	1C(Opt)	1C(Opt)
AC internal resistance	≤5mΩ	≤5mΩ	≤5mΩ	≤5mΩ
Dimension (W/H/D)	360/285/692mm	360/285/692mm	360/285/692mm	360/285/692mm
Weight	≤74.5kg	≤74.5kg	≤74.5kg	≤74.5kg

	BC75T BR75T	BC100T BR100T	BR138T	BR145T
<b>Battery rack specification</b>				
Configuration	10 battery modules +1 BPU	14 battery modules +1 BPU	18 battery modules +1 BPU	19 battery modules +1 BPU
Rated capacity	200Ah	200Ah	200Ah	200Ah
Rated energy	76.8kWh	107.52kWh	138.24kWh	145.92kWh
Rated voltage	384V	537.6V	691.2V	729.6V
Voltage range	336V-438V	470.4V-613.2V	604.8V-766.8V	638.4V-832.2V
Rated charge/discharge	0.5C	0.5C	0.5C	0.5C
Rated charge/discharge	1C(Opt)	1C(Opt)	1C(Opt)	1C(Opt)
AC internal resistance	≤50mΩ	≤70mΩ	≤90mΩ	≤95mΩ
Display	7" Touch screen	7" Touch screen	7" Touch screen	7" Touch screen
BMS	Included	Included	Included	Included
Communication	CAN	CAN	CAN	CAN
Monitoring	RS485	RS485	RS485	RS485
Max. altitude	3000m	3000m	3000m	3000m
Dimension (W/H/D) mm	1310/2150/1025	1119/2150/660	1310/2150/1025	1119/2150/660
Weight	≤1130kg	≤877kg	≤1436kg	≤1183kg
Protection degree	IP54	IP20	IP54	IP20

	BC75T BR75T	BC100T BR100T	BR138T	BR145T
<b>Balancing methods</b>				
Passive cell balancing	Yes	Yes	Yes	Yes
Active cell balancing	Opt	Opt	Opt	Opt

	BC75T BR75T	BC100T BR100T	BR138T	BR145T
<b>BMS parameters on LCD</b>				
Cell voltage	Yes	Yes	Yes	Yes
Cell high voltage	Yes	Yes	Yes	Yes
Battery SOC	Yes	Yes	Yes	Yes
Cell temperature	Yes	Yes	Yes	Yes
Charge and discharge current	Yes	Yes	Yes	Yes
Cell low voltage	Yes	Yes	Yes	Yes
Total battery voltage	Yes	Yes	Yes	Yes
Fault warning	Yes	Yes	Yes	Yes







	BC75T BR75T	BC100T BR100T	BR138T	BR145T
<b>Protection</b>				
Short circuit protection	Yes	Yes	Yes	Yes
Over current protection	Yes	Yes	Yes	Yes
Over charge protection	Yes	Yes	Yes	Yes
Over temperature protection	Yes	Yes	Yes	Yes
Cell over voltage protection	Yes	Yes	Yes	Yes
Cell under voltage protection	Yes	Yes	Yes	Yes
Over discharge protection	Yes	Yes	Yes	Yes

	BC75T BR75T	BC100T BR100T	BR138T	BR145T
<b>Certificate</b>				
	CE, UL, UN38.3, IEC62619, MSDS, ROHS, CB			

# BR114R/129R/143R/157R

Indoor battery rack with IP20 protection level, inbuilt lithium-ion battery and BMS.

## Features

-  Flexible modular design
-  Self-developed 3-level BMS
-  Easy connection method for A&B Module
-  Remote monitoring and upgrade
-  Long cycle Life, 6000 cycles
-  High density, 166wh/kg

Note: At specific test condition.



	BR114R	BR129R	BR143R	BR157R	BR114R for container
<b>Battery module specification</b>					
Configuration	16S1P	16S1P	16S1P	16S1P	16S1P
Rated capacity	280Ah	280Ah	280Ah	280Ah	280Ah
Rated energy	14.336kWh	14.336kWh	14.336kWh	14.336kWh	14.336kWh
Rated voltage	51.2V	51.2V	51.2V	51.2V	51.2V
Voltage range	44.8~57.6V	44.8~57.6V	44.8~57.6V	44.8~57.6V	44.8~57.6V
Rated charge/discharge	0.5C	0.5C	0.5C	0.5C	0.5C
Rated charge/discharge	1C(Opt)	1C(Opt)	1C(Opt)	1C(Opt)	1C(Opt)
AC internal resistance	≤8mΩ	≤8mΩ	≤8mΩ	≤8mΩ	≤8mΩ
Dimension(W/H/D)	523/231/805mm	523/231/805mm	523/231/805mm	523/231/805mm	523/231/805mm
Weight	113kg	113kg	113kg	113kg	113kg

	BR114R	BR129R	BR143R	BR157R	BR114R for container
<b>Battery rack specification</b>					
Configuration	8 modules + 1 BPU	9 modules + 1 BPU	10 modules + 1 BPU	11 modules + 1 BPU	8 modules + 1 BPU
Rated capacity	280Ah	280Ah	280Ah	280Ah	280Ah
Rated energy	114.688kWh	129.024kWh	143.36kWh	157.696kWh	114.688kWh
Rated voltage	409.6V	460.8V	512V	563.2V	409.6V
Voltage range	358.4~460.8V	403.2~518.4V	448~576V	492.8~633.6V	358.4~460.8V
Rated charge/discharge	0.5C	0.5C	0.5C	0.5C	0.5C
Rated charge/discharge	1C(Opt)	1C(Opt)	1C(Opt)	1C(Opt)	1C(Opt)
AC internal resistance	≤64mΩ	≤72mΩ	≤80mΩ	≤88mΩ	≤64mΩ
Display	7" Touch screen	7" Touch screen	7" Touch screen	7" Touch screen	7" Touch screen
BMS	Included	Included	Included	Included	Included
Communication	CAN	CAN	CAN	CAN	CAN
Monitoring	RS485	RS485	RS485	RS485	RS485
Max. altitude	3000m	3000m	3000m	3000m	3000m
Dimension(W/H/D)mm	1055/1615/755(0.5C) 1090/1615/755(1C)	1055/1615/755(0.5C) 1090/1615/755(1C)	1055/1615/755(0.5C) 1090/1615/755(1C)	1055/1615/755(0.5C) 1090/1615/755(1C)	528/2380/755(0.5C) 528/2380/755(1C)
Weight	1064kg	1157kg	1270kg	1383kg	999kg
Protection degree	IP20	IP20	IP20	IP20	IP20

	BR114R	BR129R	BR143R	BR157R	BR114R for container
<b>BMS parameters on LCD</b>					
Cell voltage	Yes	Yes	Yes	Yes	Yes
Cell high voltage	Yes	Yes	Yes	Yes	Yes
Cell low voltage	Yes	Yes	Yes	Yes	Yes
Cell temperature	Yes	Yes	Yes	Yes	Yes
Charge and discharge current	Yes	Yes	Yes	Yes	Yes
Total battery voltage	Yes	Yes	Yes	Yes	Yes
Battery SOC	Yes	Yes	Yes	Yes	Yes
Fault warning	Yes	Yes	Yes	Yes	Yes

	BR114R	BR129R	BR143R	BR157R	BR114R for container
<b>Protection</b>					
Short circuit protection	Yes	Yes	Yes	Yes	Yes
Over current protection	Yes	Yes	Yes	Yes	Yes
Over charge protection	Yes	Yes	Yes	Yes	Yes
Over discharge protection	Yes	Yes	Yes	Yes	Yes
Cell over voltage protection	Yes	Yes	Yes	Yes	Yes
Cell under voltage protection	Yes	Yes	Yes	Yes	Yes
Over temperature protection	Yes	Yes	Yes	Yes	Yes





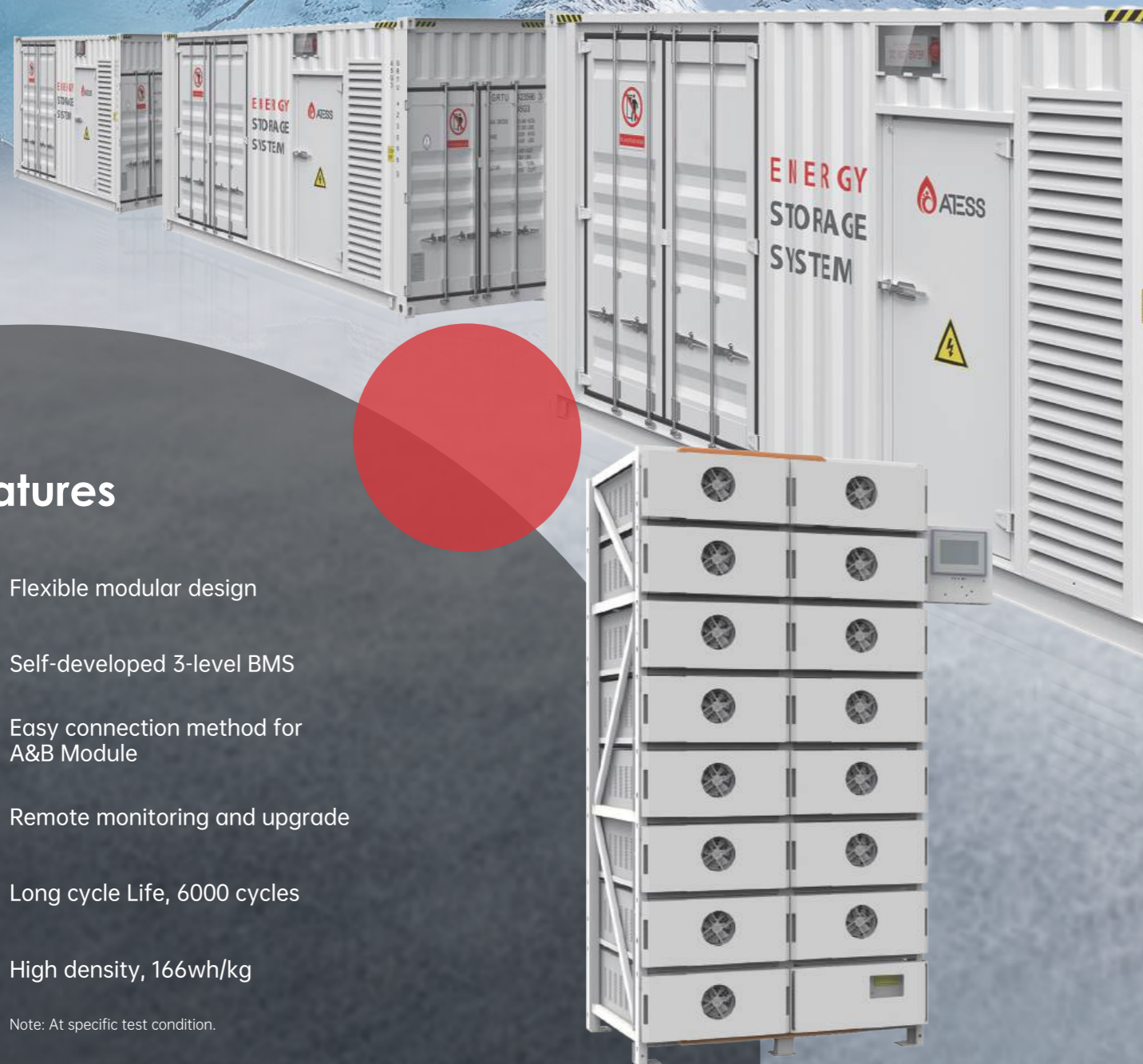

	BR114R	BR129R	BR143R	BR157R	BR114R for container
<b>Certificate</b>					
	CE, CB, UL, UN38.3, IEC62619, MSDS, ROHS				

# BR172R/186R/200R/215R

Indoor battery rack with IP20 protection level, inbuilt lithium-ion battery and BMS.



## Features

-  Flexible modular design
-  Self-developed 3-level BMS
-  Easy connection method for A&B Module
-  Remote monitoring and upgrade
-  Long cycle Life, 6000 cycles
-  High density, 166wh/kg

Note: At specific test condition.

	BR172R	BR186R	BR200R	BR215R
<b>Battery module specification</b>				
Configuration	16S1P	16S1P	16S1P	16S1P
Rated capacity	280Ah	280Ah	280Ah	280Ah
Rated energy	14.336kWh	14.336kWh	14.336kWh	14.336kWh
Rated voltage	51.2V	51.2V	51.2V	51.2V
Voltage range	44.8~57.6V	44.8~57.6V	44.8~57.6V	44.8~57.6V
Rated charge/discharge	0.5C	0.5C	0.5C	0.5C
Rated charge/discharge	1C(Opt)	1C(Opt)	1C(Opt)	1C(Opt)
AC internal resistance	≤8mΩ	≤8mΩ	≤8mΩ	≤8mΩ
Dimension(W/H/D)	523/231/805mm	523/231/805mm	523/231/805mm	523/231/805mm
Weight	113kg	113kg	113kg	113kg

	BR172R	BR186R	BR200R	BR215R
<b>Battery rack specification</b>				
Configuration	12 modules + 1 BPU	13 modules + 1 BPU	14 modules + 1 BPU	15 modules + 1 BPU
Rated capacity	280Ah	280Ah	280Ah	280Ah
Rated energy	172.032kWh	186.386kWh	200.704kWh	215.04kWh
Rated voltage	614.4V	665.6V	716.8V	768V
Voltage range	537.6~691.2V	582.4~748.8V	627.2~806.4V	672~864V
Rated charge/discharge	0.5C	0.5C	0.5C	0.5C
Rated charge/discharge	1C(Opt)	1C(Opt)	1C(Opt)	1C(Opt)
AC internal resistance	≤96mΩ	≤104mΩ	≤112mΩ	≤120mΩ
Display	7" Touch screen	7" Touch screen	7" Touch screen	7" Touch screen
BMS	Included	Included	Included	Included
Communication	CAN	CAN	CAN	CAN
Monitoring	RS485	RS485	RS485	RS485
Max. altitude	3000m	3000m	3000m	3000m
Dimension(W/H/D)mm	1055/2125/755(0.5C) 1090/2125/755(1C)	1055/2125/755(0.5C) 1090/2125/755(1C)	1055/2125/755(0.5C) 1090/2125/755(1C)	1055/2125/755(0.5C) 1090/2125/755(1C)
Weight	1511kg	1624kg	1737kg	1850kg
Protection degree	IP20	IP20	IP20	IP20

	BR172R	BR186R	BR200R	BR215R
<b>BMS parameters on LCD</b>				
Cell voltage	Yes	Yes	Yes	Yes
Cell high voltage	Yes	Yes	Yes	Yes
Cell low voltage	Yes	Yes	Yes	Yes
Cell temperature	Yes	Yes	Yes	Yes
Charge and discharge current	Yes	Yes	Yes	Yes
Total battery voltage	Yes	Yes	Yes	Yes
Battery SOC	Yes	Yes	Yes	Yes
Fault warning	Yes	Yes	Yes	Yes

	BR172R	BR186R	BR200R	BR215R
<b>Protection</b>				
Short circuit protection	Yes	Yes	Yes	Yes
Over current protection	Yes	Yes	Yes	Yes
Over charge protection	Yes	Yes	Yes	Yes
Over discharge protection	Yes	Yes	Yes	Yes
Cell over voltage protection	Yes	Yes	Yes	Yes
Cell under voltage protection	Yes	Yes	Yes	Yes
Over temperature protection	Yes	Yes	Yes	Yes

	BR172R	BR186R	BR200R	BR215R
<b>Certificate</b>				
	CE, CB, UL, UN38.3, IEC62619, MSDS, ROHS			

# EnerLog

Data logger for overall system monitoring collects operation data from different units via Modbus RS485 and communicates with the ATESS server via Ethernet.

## Features

-  Up to 32 devices connection
-  Support external sensors to realize the zero-export function
-  Multi-function and high performance
-  Local web server for easy configuration

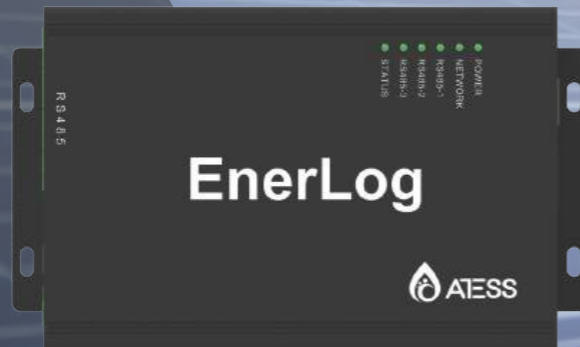

## EnerLog

### Hardware Parameters

Power adapter	Input: 100-240V, 50/60Hz AC Output 12V(+/-15%), 1A DC
Power consumption	2.5W

### Application Parameters

Max. communication range	500m
Communication with inverters	RS485
Communication with server	TCP(Modbus TCP protocol)
Support network	Ethernet
Data transfer interval	5 Minutes
Default server URL	ess-server.atesspower.com







### General Information

Dimension(W/H/D)	175/105/31mm
Weight	320g
Language	Chinese, English
Mounting	Wall-mounted
Operating temperature	-30°C~+60°C
Degree of protection	IP30
Warranty	1 year
Certificate	CE

# EnerClo

ATESS monitoring cloud platform for different applications including residential, commercial, and utility grade on/off grid solar storage systems.

## Features

-  Quick and easy overview
-  Professional analysis
-  PC and mobile phone accessible
-  Real-time monitoring
-  Detail report downloadable
-  Online control and maintenance



## EnerClo

### Languages

Available languages Chinese, English, French, Greek, German, Netherlands, Italian, Japanese, Polish, Portuguese, Spanish, Turkish, Vietnamese, Korean

### System Requirments

Supported operating systems All  
 Recommended browsers Internet explore 8, Firefox 5, Google chrome 14, Safari 5, Opera 11  
 Supported data logger EnerLog

### Access

Website [www.enerclo-atesspower.com](http://www.enerclo-atesspower.com)

### Plant Information

Plant overview Quick yield overview of all your PV plants  
 Specified plant All important data at a glance including energy output, yield gains, environment status  
 Plant installation data Summary of all plant information which contains installation data, location data and other key devices  
 Device overview Display of all important data about data logger, environment monitor and other key devices  
 Time period 5 mins

### Plant Management

Account User could manage all PV plants with one same account

### Monitoring

Inverter status All inverter running status are recorded automatically, the warning of fault is highlighted immediately

### Status Reporting

Event reports Timely e-mail reports on system fault and plant error

### Background Operating







Plant management Add new plant, edit and delete existing plant  
 Device management Intuitive operation to manage all devices  
 Inverter setting Simple parameters setting for inverters including power management



# EnerView

Mobile phone app available on both IOS and Android to access EnerClo for online monitoring and maintenance

## Features

-  Quick and easy overview
-  Professional analysis
-  PC and mobile phone accessible
-  Real-time monitoring
-  Detail report downloadable
-  Online control and maintenance



## EnerView

### General Data

Available languages	English, Chinese
Supported operating systems	Android/iOS
Recommended browsers	All
Source of data	ess-server.atesspower.com
Supported data logger	EnerLog

### Plant Information

Plant overview	Quick yield overview of all your PV plants
Specified plant	All important data at a glance including energy output, yield gains, environment status
Device overview	Display of all important data about the data logger, environment monitor, and other key devices
Plant event log	Display of all the warning events of the plant

### Device Information







Inverter status	All inverters' running status is recorded automatically, and the warning of fault is highlighted immediately
Event reports	Timely e-mail reports on system fault and plant error
Plant management	Add a new plant, edit and delete the existing plant
Device management	intuitive operation to manage all devices
Inverter setting	Simple parameters setting for inverters including power management

# NOVO EVA-07/09/12S-PU

Single-phase AC home electric vehicle charging station, Type 1 plug, single output, US standard.



## Features

-  Programmable charging mode
-  Compact and exquisite
-  Comprehensive protection
-  US standard
-  Multiple communication modes
-  Flexible installation







Model	NOVO EVA-07S-PU	NOVO EVA-09S-PU	NOVO EVA-12S-PU
<b>Input &amp; Output</b>			
Input voltage	240V AC	240V AC	240V AC
Input frequency		60Hz	
Output voltage	240V AC	240V AC	240V AC
Max.output power	7.6kW	9.6kW	12kW
Max.output current	32A	40A	50A
Charging interface type		Type1	
Connection		Plug	
Cable Length		25ft(7.6m)	
Number of connection		1	
<b>Protection</b>			
Over voltage protection		Yes	
Under voltage protection		Yes	
Over load protection		Yes	
Earth leakage protection		20mA CCID	
Over-temp protection		Yes	
Lightning protection		Yes	
<b>Function &amp; Accessory</b>			
Ethernet/WIFI/4G		Yes/Yes/Opt	
LCD		Opt	
Charging Mode		APP / RFID(Opt) / Plug and charge	
LED Indicator Light		Yes	
Intelligent power adjustment		Yes	
PV linkage		Yes	
Installation		Floor/wall-mounting	
Appearance colour		Black/Silver	
OCP		1.6JSON	
<b>Working Environment</b>			
Ingress Protection		NEMA 3R	
Operating temperature		-22°F ~+122°F	
Relative humidity		5-95% non-condensing	
Maximum altitude		6500ft(2000m)	
Cooling		Natural cooling	
Standby power consumption		<8W	
<b>Mechanical</b>			
Dimension (W/H/D)		246/382/162mm	
Weight	<5kg	<6kg	<7kg
<b>Certificate &amp; Standard</b>			
Certificate		UL, CSA	
Standard		UL2594, CSA-C22.2, UL2231-1, UL2231-2, UL1998, FCC part15	

# EVD-40SU EVD-40DU

Large capacity fast DC EV charging station for public use, CCS Type 1 plug, US standard.



## Features

-  Programmable charging mode
-  Comprehensive protection
-  Multiple communication modes
-  7 inch touch screen
-  US standard
-  Flexible installation





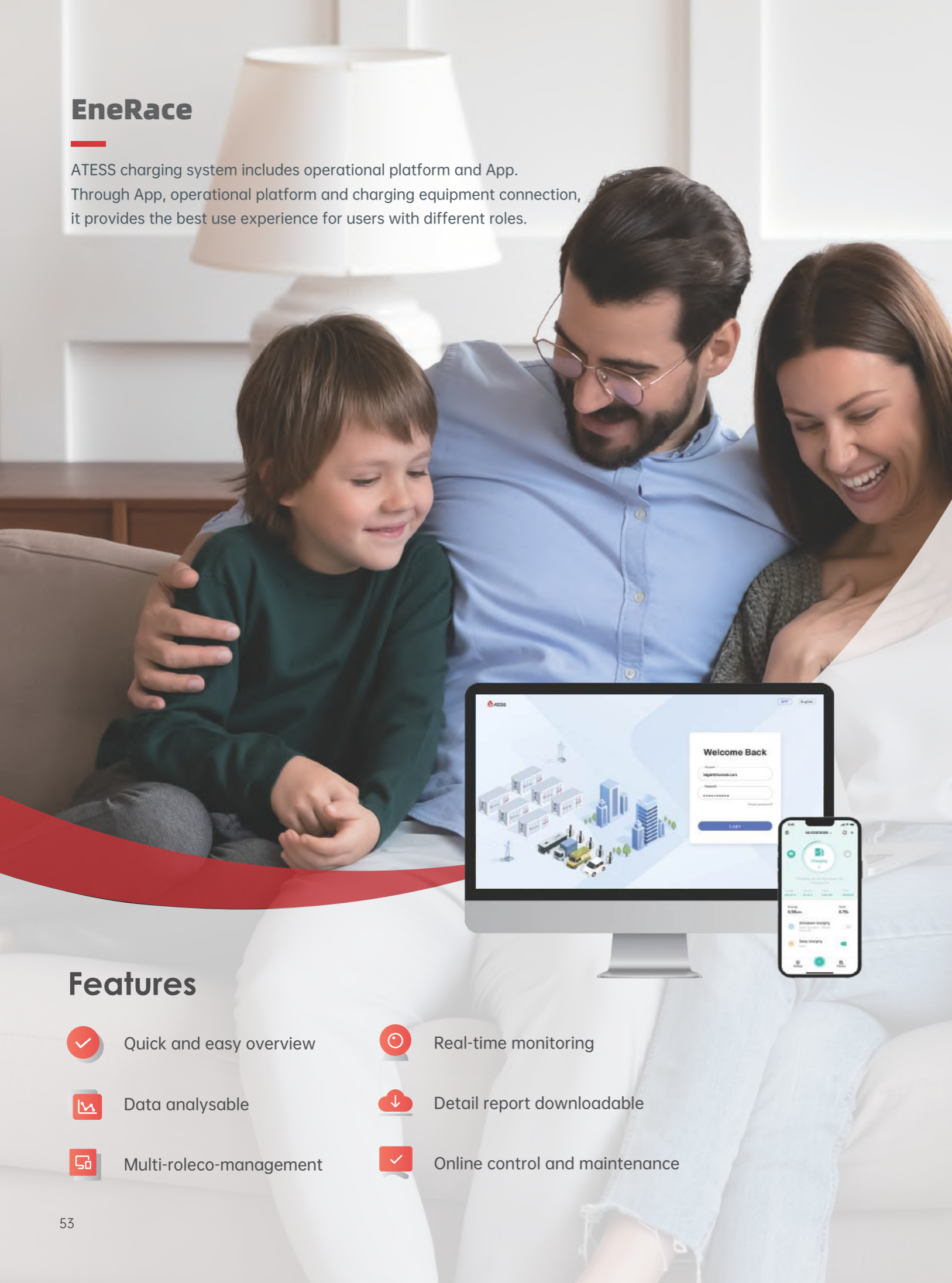

Model	EVD-40SU	EVD-40DU
<b>Input &amp; Output</b>		
Rated input voltage	208/240/480 VAC	
Rated input current	110/102/51A	
AC input connection	L1/L2/L3/PE(Three phase, No Neutral)	
Rated frequency	60Hz	
DC connector type	SAE J1772 CCS1	
Output voltage Range	150-1000V	
Max.output power	37.6-40KW	
Max.output current	100A	Single output: 100A Double output: 100A
Voltage accuracy	±0.5%	
Current accuracy	±1% (at 20%-100% of rated power)	
Voltage-regulating accuracy	±0.5%	
Current-regulating accuracy	±1%	
Ripple coefficient	Peak±1%	
Metering accuracy	0.50%	
Efficiency	>95%	
Power factor	98%	
Cable length	16ft(5m)	
<b>Protection</b>		
Over voltage protection	Yes	
Under voltage protection	Yes	
Over load protection	Yes	
Over-temp protection	Yes	
Lightning protection	Yes	
Emergency Protection	Yes	
<b>Function &amp; Accessory</b>		
Display	7 inch touch screen	
Ethernet/WIFI/4G	Yes/Yes/Opt	
Charging mode	APP/ RFID(Opt) /plug and charge	
Indicator	Yes	
Ocpp	1.6JSON	
<b>Working Environment</b>		
Ingress Protection	NEMA 3R	
Operating temperature	-22°F ~+122°F	
Relative humidity	5-95% non-condensing	
Maximum altitude	6500ft(2000m)	
Cooling	Forced air	
Standby power consumption	<40W	
Noise emission	≤65db	
<b>Mechanical</b>		
Dimension (W/H/D)	632/858/300mm	
Weight	80kg	92kg
<b>Certificate</b>	UL, CSA	



# EneRace

ATESS charging system includes operational platform and App. Through App, operational platform and charging equipment connection, it provides the best use experience for users with different roles.



## Features

-  Quick and easy overview
-  Real-time monitoring
-  Data analysable
-  Detail report downloadable
-  Multi-roleco-management
-  Online control and maintenance

EneRace	
Charging system	The charging system includes operational platform and App. Through App, operational platform and charging equipment connection, it provides the best use experience for users with different roles.
Operational platform	Operational platform mainly for operators to provide user management, monitoring and fault early warning, RFID card charger management functions such as service.
Mobile APP	Mobile App for end users to provide remote monitoring, charging in advance, peak valley charging function such as service.  <div style="display: flex; justify-content: space-around; align-items: center;">   </div> <div style="display: flex; justify-content: space-around; align-items: center;">   </div>

# Accessories



Model	NOVO EVA-07/09/12S-PU
Mounting pole	
Dimension (W/H/D)	255/1500/154mm
Weight	11kg



Model	EVD-40SU	EVD-40DU
Mounting pole		
Dimension (W/H/D)	500/1652/300mm	
Weight	31kg	



Model	CARD WRITER
Contactless IC card	Supports Mifare 1 cards, TypeA CPU cards, and TypeB CPU cards that comply with the ISO14443 standard widely applied in the market.
Standard	RF interface that complies with ISO/IEC14443 TypeA and TypeB standard
Working frequency	13.56 MHz
Perating temperature	-20°C ~ 65°C;
Storage temperature	-20°C ~ 70°C;
Relative humidity	20-90%
Protection	TypeA CPU cards and TypeB CPU cards (embedded with CPU chips) for better encryption and security



Model	Multi-charge manager		
Specification			
System capacity	103.5KW	172.5KW	414KW
Normal input voltage/ range	400Vac 320~480Vac		
Normal input frequency/ range	50/60Hz 45-55Hz/55-65Hz		
Max. detection current	150A	250A	600A
Charger max. connection number	32PCS		
Max. communication distance	RS485 shielded twisted pair cable : 500m Ethernet cable : 100m		
Dimensions(W/H/D)	364*335*145mm		
Weight	6.5KG		
Operating temperature	-20°C~+50°C		
Protection degree	IP 65		
Relative humidity	0~95%		
Certification	CE		

## Racecourse storage power station

Location: Jamaica  
Capacity: 1.7MW / 5MWh  
Product: HPS100/PCS500, BR100/145



# America



### Peruvian Amazon Basin

Location: Perú  
Capacity: ESS 540kW/ 1666.56kWh  
Product: HPS150\*2, HPS120\*2, BR217



### Auaris

Location: Brazil  
Capacity: ESS100kW/ 248.4kWh  
Product: HPS50\*2



### 3 off-grid power plants in Jujuy

Location: Argentina  
Capacity: ESS 540kW/ 1945.2kWh  
Product: HPS120\*2, HPS100\*2, HPS50\*2



### Brazilian military hybrid Project

Location: Jamaica  
Capacity: 100kW/200kWh  
Product: HPS100

# Asparagus processing factory

Location: Germany  
Capacity: 450kW / 464kWh  
Product: HPS150

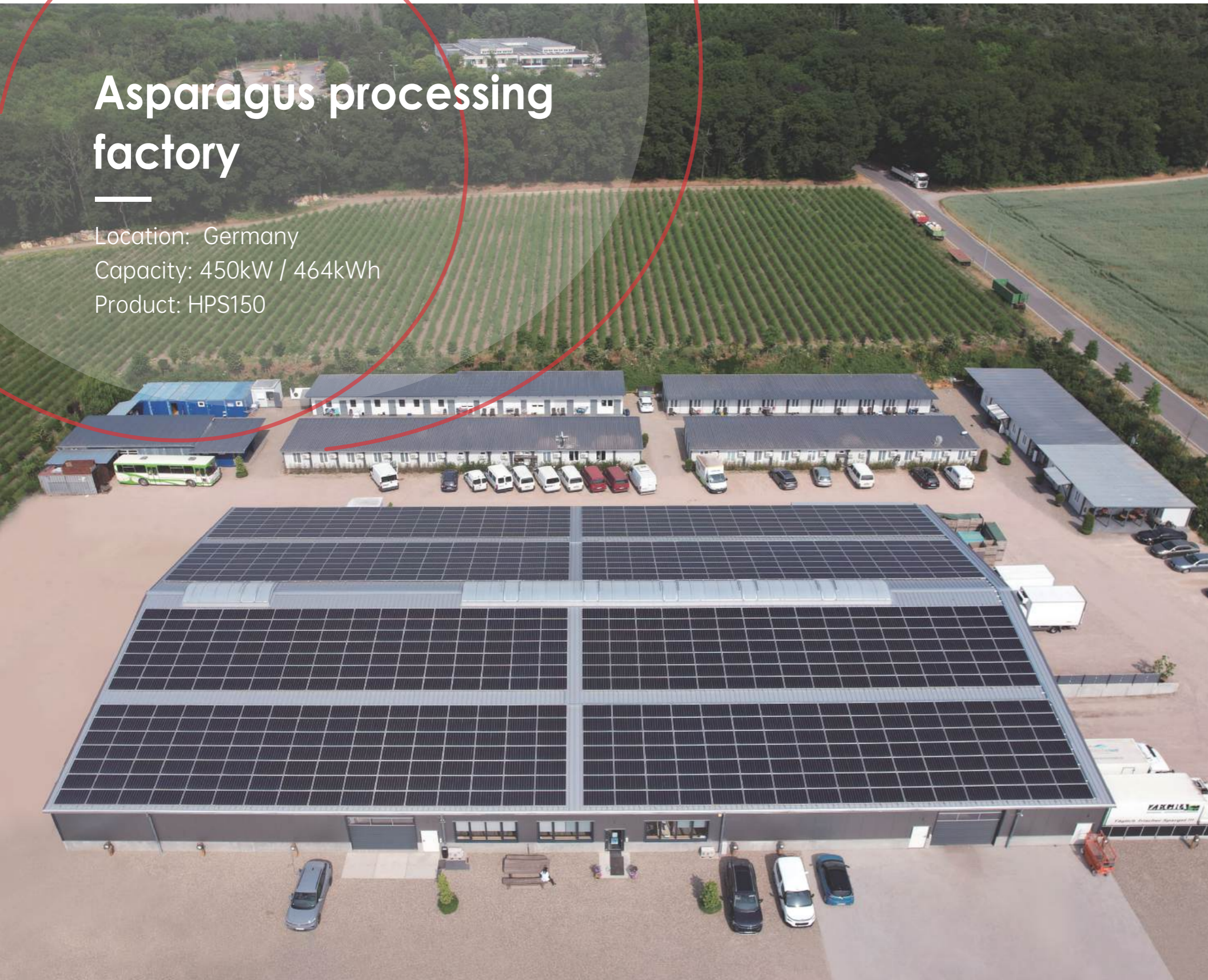

## Micro grid system for remote village

Location: Suriname  
Capacity: 250kW / 1MWh  
Product: PCS250



## Hybrid power plant

Location: Poland  
Capacity: 250kW / 500kWh  
Product: HPS50, BR100T



## Load-shedding application

Location: South Africa  
Capacity: 750kW / 1.5MWh  
Product: PCS250



## Hybrid power station for factory

Location: South Africa  
Capacity: 1MW / 1.3MWh  
Product: PCS500



## Charging station for business district

Location: UK  
Product: EVD-40D



## Charging station for business district

Location: UK  
Product: EVA-22D-SE



## Public charging station

Location: France  
Product: REVO EVD-180D



## Sideway charging station

Location: Italy  
Product: EVD-40S



## Fast charging station for 4S store

Location: Hungary  
Product: EVC-AC22D/DC150D