



ATESS EVD-80-200D-X
DC EV charging station
User Manual

SHENZHEN ATESS POWER TECHNOLOGY CO.,LTD

GROWATT-ATESS Industrial Park, No.23 Zhulongtian Road, Shuitian Community,
Shiyan Street, Baoan District, Shenzhen

Tel: +86 755 2998 8492

Web: www.atesspower.com

Email: info@atesspower.com

Revised date: 2024-06-06

Copyright Notice

This user manual is copyrighted by Shenzhen ATESS Power Technology Co., Ltd. (hereinafter referred to as "ATESS Power Technology"). No unit or individual may extract or copy part or all of this user manual without the written permission of the company. Content must not be transmitted in any form, including materials and publications.

All rights reserved. ATESS Power Technology has the final interpretation of this user manual. The product specification may be updated from time to time and is subject to change without prior notice!

Thank you for choosing ATESS

ATESS EVD series intelligent DC EV charging station is a device that provides high-efficiency, safe and stable DC power supply for electric vehicles, which has a friendly man-machine interface and integrates corresponding functions of control, billing, communication and security protection. The charging equipment uses OCPP 1.6JSON open protocol for communication with back-office server, thus to realize functions such as reservation and network payment via mobile APP. Diversified communication options, including wired Ethernet, WIFI, 4G, wireless, are provided for customers to conveniently connect the device to a charging network. This product supports CCS2. Each connector works independently. Up to 2 EV could be charged at the same time. All the above features make it most suitable for outdoor charging.

We sincerely hope that this product can meet your needs, and we welcome and value your feedback and suggestions on the performance and function of the product. We will continuously improve the quality of our products and services.

Contents

1 Product description

2 Packaging list

3 Installation and wiring

3.1 Installation conditions
3.2 Cable connection

4 Parameter configuration

4.1 System Parameters
4.2 Network parameters
4.3 Protection parameters

5 Operation instruction
and LCD introduction

5.1 Charging mode and operation
5.2 LCD interface introduction
5.3 Troubleshooting

6 Specification

7 Appendix

7.1 Electric diagram
7.2 Module installation
7.3 Warranty
7.4 Contact

1 Product Description

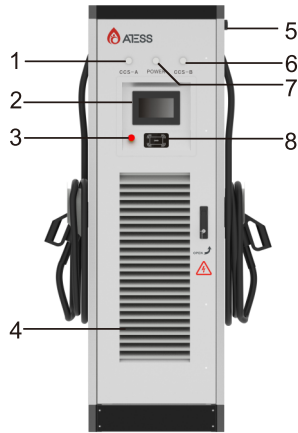

1. CCS2-A connector indicator(charging yellow/fault red)
2. HMI
3. Emergency stop button
4. Air inlet
5. WIFI/4G antenna
6. CCS2-B connector indicator(charging yellow/fault red)
7. Power indicator
8. RFID reader

Internal view and terminal definition

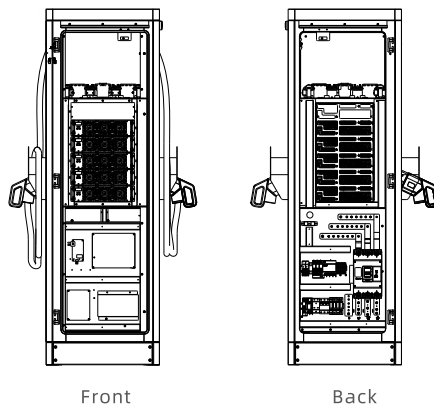

Crimp the below shown ring terminals on the end of the AC input wires and PE wires.
Connect the wires into the terminal block of the chargepoint as below.
Check the wiring then close the switch and the door.

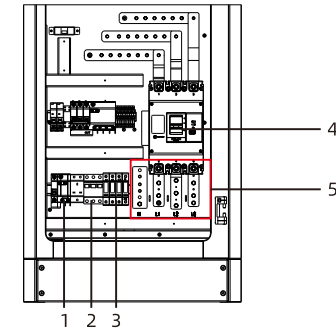

1. Auxiliary power control breaker
2. Breaker in surge protection circuit
3. SPD
4. Main power control breaker
5. AC input cable copper bar. Terminal definition is (N PE L1 L2 L3)



Fig: AC Surge protection device

Note: The charging equipment will detect the current status of the lightning arrester module in real time. When the lightning protection module is damaged, the display will have an alarm indicating that the lightning protection device is faulty. When repairing and replacing the lightning protection module. Then the maintenance person can operate the breaker in the surge protection circuit and replace the lightning protection module.(The red circle in the figure is the lightning protection status indicator. When the indication window indicates green, the lightning protection module is normal; when the indication window indicates red, the lightning protection module has been broken and damaged, and the lightning protection module needs to be replaced.)

2 Packaging List

No.	Items	Qty	Remark
1	DC EV charging station	1	
2	User manual	1	
3	Certificate of quality	1	
4	User card	3	
5	Hexagon head bolt, all thread,M12*90/GB5783, blue zinc plating	4	
6	Plain Washer,D12/GB97 1, plated blue zinc	8	
7	Standard Spring Washer,D12/GB93, plated blue zinc	4	
8	Hexagon Nuts,M12/GB6170, electro plated blue zinc	4	

3 Installation and Wiring

3.1 Installation conditions

1) keep a minimum clearance of 1.2m all around the charger, as follows:



2) The charger must be installed on a customized concrete foundation, the foundation is as below:

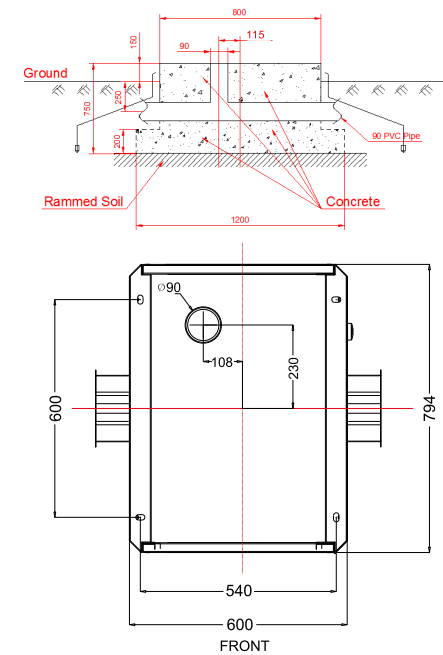

Concrete foundation diagram

Annotation:

- 1.The foundation pile must be tamped. On loose and moist soil, the foundation must be reinforced. The foundation must sit at the highest point of the area to avoid flooding water.
- 2.The foundation pile is to be made of reinforced concrete, which requires for a minimum allowable bearing pressure of 1000kg/squire meters for the base.
- 3.Construct main grounding busbar and electrode following the grounding regulation of transformer substation. Grounding resistance should be lower than 4Ω , 50x4 galvanized flat steel is suggested.
- 4.Cable conduit uses PVG of 90mm diameter, the direction should be determined according to the situation on site, while the quantity is according to how many HV/LV cables will be used(use redundant design) .
- 5.Level bar should be used to level the foundation ground.
- 6.Internal foundation level should slightly lean towards water collecting pit.
- 7.The figure is just for reference.

3) The minimum height of foundation is 150mm above ground, the vertical inclination degree should be less than 5%.

Parameter configuration 4

3.2 Cable connection

Connect the buried three phase four wire AC cables to the input terminal of the charger with correct color order and phase sequence. The earth cable shall be connected to the grounding bar of the charger. Wiring illustration is shown in below.

Please notice: For safety, the charger must be grounded securely.

Connect the grounding bar of the charger to the equipotential bonding bar of the installation site. The grounding cable should be no less than 70mm². Grounding resistance shall be less than 4Ω.

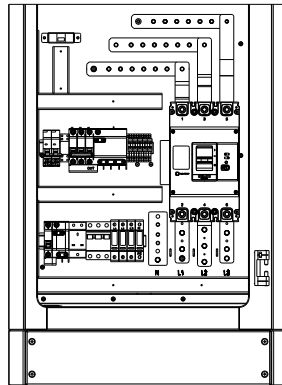

	L1	L2	L3	N	PE
Terminal					
Wire	≥120mm ² ≥AWG4/0	≥120mm ² ≥AWG4/0	≥120mm ² ≥AWG4/0	≥120mm ² ≥AWG4/0	≥70mm ² ≥AWG2/0

Notice:

1. Only professional personnel can do the wiring, connect the AC input wires in correct phase order according to the markings on the terminal block.
2. The PE terminal shall be connected to the Earth firmly and reliably.
3. No live work! Turn off the upstream breaker in the distribution panel and the breaker inside the charging equipment before repairing or maintaining.
4. Please do no disassemble the unit unless authorized.

After installed and connected, the charging equipment must first be configured according to the actual needs of the user. The parameters are configured through the LCD touch screen. Save the change and exit then the charging equipment can be used normally.

Welcome to use DC charger

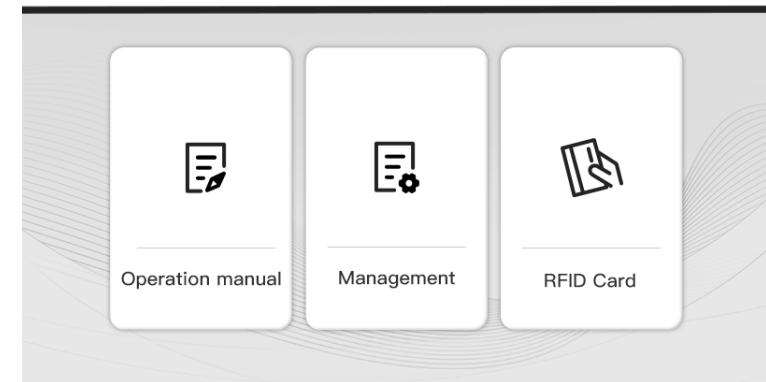

After the system enters standby, click the button marked by the red rectangle in the above figure to enter the system management page, as shown below.

Management

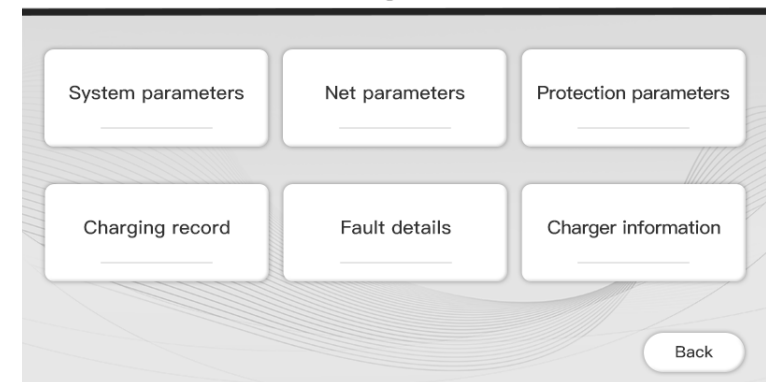

System management page

4.1 System Parameters

System parameters

System Parameters page

No.	Parameters	Function description
1	RFID card PIN code	PIN code setting of RFID reader, a 6-digit code, the default setting is 242007.It must be the same with the PIN code of user card. Users can also use other PIN code if they have card writer to change PIN code of user card.
2	VIN charge setting	Custom function
3	Charge ID	Suggested touse serial number as charger ID.
4	Password set	Password of management page. It's a 4-digit fixed length password, default is "1234" .
5	Meter address	DC meter's modbus address(already preset in factory, it is not allowed to modify)
6	Time set	System time setting. Format is Y, M, D, H, M, S. The year setting can only set the last 2 digits, e.g. use 22 for 2022.

No.	Parameters	Function description
7	Charge type	Charging mode setting. 1 is APP mode; 2 is RFID mode; 3 is Plug&charge mode
8	Language set	Language setting. Currently support English and France dual language display.
9	DC	Charge model (already preset in factory)
10	AC	Charge model (already preset in factory)

After changing parameters, click the "Set" button to save the setting, then click the "Back" button for the setting to take effect.

4.2 Network parameters

Network parameters need to be configured when the charging station needs to be connected to back office server for operation and management. Network parameters include server parameters and charger parameters. Currently the charging equipment support LAN connection ,WIFI/4G.

Network parameters

No.	Parameters	Function description
1	Server URL1	Server address setting, used to set domain or IP address of back-office server.
2	Server URL2	Address of backup server. This parameter is not available now, reserved for future use.
3	Charger IP	IP setting of the charging equipment
4	Subnet mask	Subnet mask setting
5	Gateway	Gateway setting
6	DNS	DNS server address
7	MAC Addr	MAC address
8	4G APN	4G APN
9	4G user name	4G user name
10	4G password	4G password
11	WIFI SSID	WIFI SSID setting, to set the name of the wireless network to which the charging equipment is to be connected. A reserved function for future use
12	WIFI Key	WiFi password setting. A reserved function for future use
13	Authentication Key	OCPP login authentication setting

If the charger is connected to the server through the network cable, the Charger IP, Subnet mask and Gateway need to be set. Through WiFi, you need to set WiFi SSID and WiFi Key. With 4G, you can connect to the server by installing a SIM card.

4.3 Protection parameters

The protection-related parameters, such as voltage, current, temperature, power, etc.

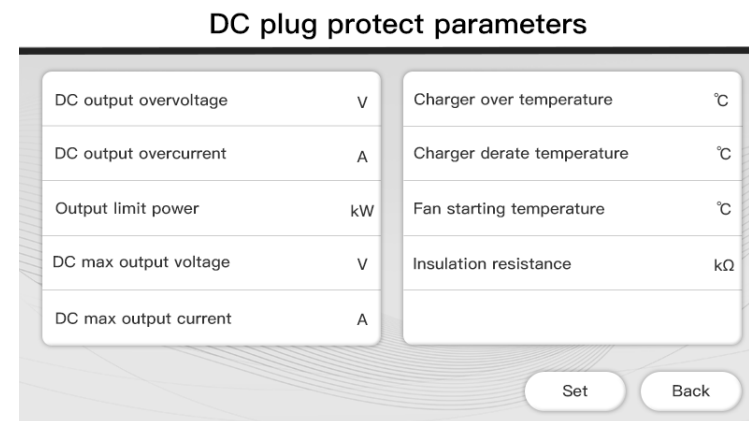

No.	Parameters	Function description
1	DC output overvoltage	Over voltage limit setting of DC output
2	DC output overcurrent	Over current limit setting of DC output
3	DC output limit power	Power limitation setting of DC output
4	DC max output voltage	DC max output voltage
5	DC max output current	DC max output current
6	Charger over temperature	Over temperature limit setting of charging connector
7	Charger derate temperature value	Charging connector's temperature at which the charging equipment starts decreasing output power
8	Fan starting temperature	Fan operating temperature
9	Insulation resistance	The min value of insulation resistance

4.4 Plug type

There are CCS2 two plugs optional.

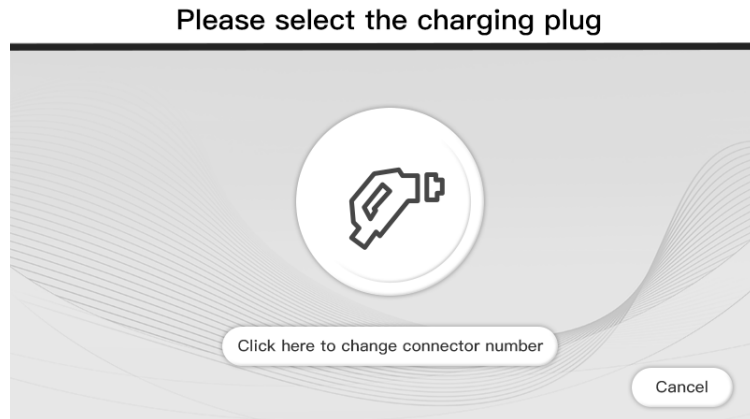

RFID mode:

Charging can only be initiated or ceased by swiping RFID card.

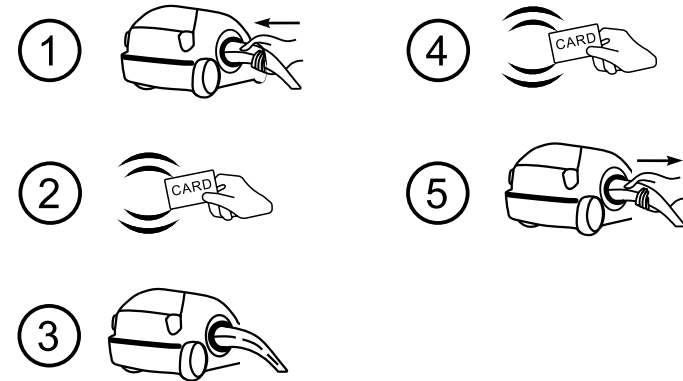

RFID mode operation process flow

5 Operation instruction and LCD introduction

5.1 Charging mode and operation

APP mode:

Initiate or cease charging by scanning QR code using APP or by swiping RFID card.

You can also use APP for reservation and payment provided that the back-office server supports such function



APP mode operation process flow

Plug&Charge:

Charging will start automatically after EV plugged in. If you want to stop the charging, just press the stop icon on the screen.

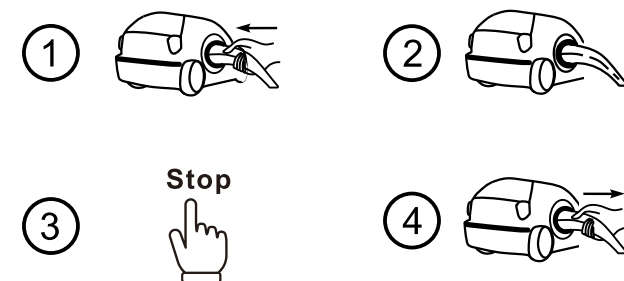

Plug&Charge mode operation process flow

5.2 LCD interface introduction

The charging equipment is equipped with a 7 inch industrial-grade resistor type touch panel. The display content is as below

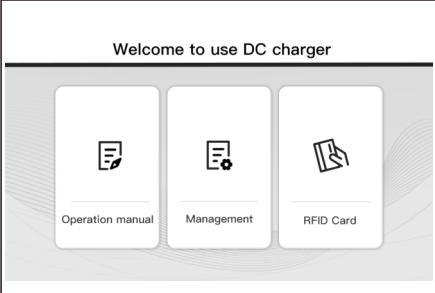
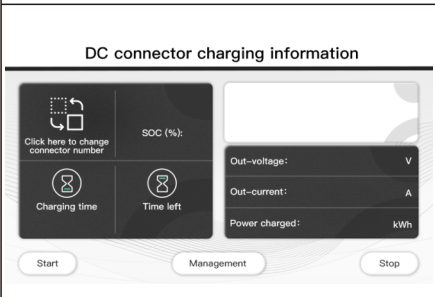
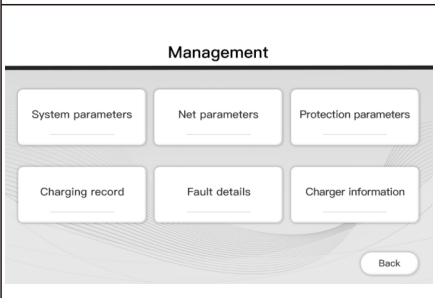
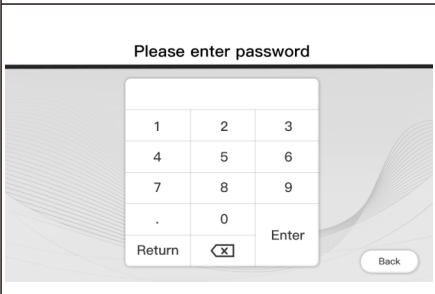
	<p>When powered up, the charging equipment will show this display</p>
	<p>Charging information, which will show the status of the charging equipment, such as standby, charging, fault, etc.</p>
	<p>Management page, user can set different kinds of parameters here. password authentication is required when entering each parameter setting page.</p>
	<p>Password window. Before entering numeric, please first press the text display field to move the cursor there, then you can type in the 4-digit password. A wrong password will cause no response and action.</p>

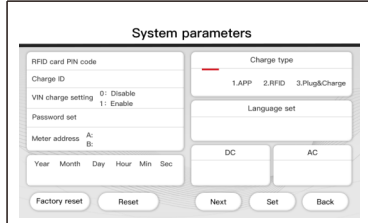
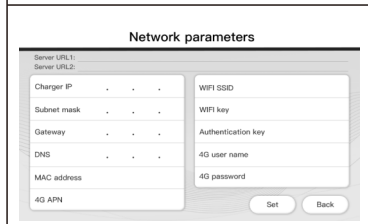
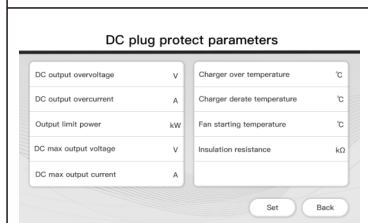
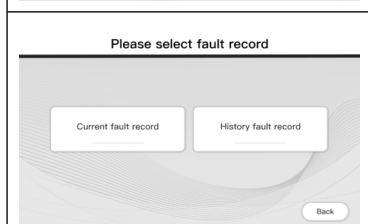
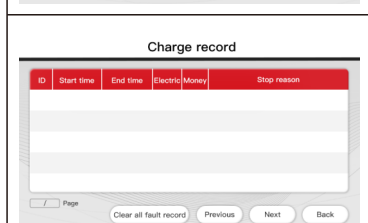
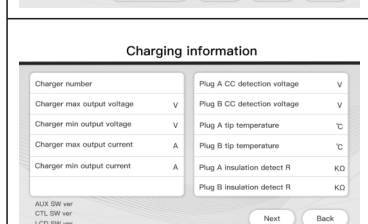
	<p>System parameters page.</p>
	<p>Network parameters page, used to set network related parameters of back-office server and the charging equipment.</p>
	<p>Protection parameters page of DC output, used to set limit value of voltage, current, power, temperature, etc.</p>
	<p>Fault record page, user can check history fault record here.</p>
	<p>Charging record page.</p>
	<p>Charging information page, to check real-time charging parameters.</p>

5.3 Troubleshooting

No.	Fault description
1	Emergency stop is pressed!
2	RFID communication fault!
3	Over temperature fault!
4	Lightning protection fault!
5	Power module communication fault!
6	Meter communication fault!
7	DC output overvoltage fault!
8	DC output overcurrent fault!
9	Waiting for BMS communication timeout!
10	Insulation detection timeout!
11	Insulation detection fault!
12	Battery voltage reverse fault!
13	DC+ Contactor sticking fault!
14	DC- Contactor sticking fault!
15	Plug line disconnection fault!
16	Plug head connection over temperature fault!
17	AC Contactor sticking fault!
18	AC Input Overvoltage!
19	AC Input Undervoltage!
20	BMS communication fault!

Model	EVD-80D~200D-X			
Dimension(mm)	787*800*1885(W*D*H)			
Weight(kg)	265-310kg			
Display	LCD			
Casing material	Stainless steel&acrylic sheet			
AC input				
Grid connection	400V, 3 phase 5 wires			
Voltage	AC 320~457V			
Current	80k	120k	160k	200k
	120A	185A	250A	305A
Frequency	50/60Hz			
DC output				
Plug type	CCS2			
Voltage	DC150~1000V			
Max current	80k	120k	160k	200k
	200A	200A	200A	200A
Voltage-stabilizing accuracy	< ±0.5%			
Current-stabilizing accuracy	< ±1%			
Power factor	≥0.98			
Efficiency	≥94%			

Ingress Protection	IP54			
Working environment	-25°C~50°C			
Relative humidity	<95%			
Altitude	≤2000m, derate for higher than 2000m			
Cooling method	Forced air cooling			
Remote monitoring	Ethernet/WIFI/4G/485/232			
Payment	RFID/APP			
Standby power	80k	120k	160k	200k
	57W	68W	79W	90W
Standards	IEC-62196-2;EN61851			
Mounting	Ground			
Certificate	CE			
Metering accuracy	0.5%			
Protection features				
Over /Under voltage of AC output	YES			
Over voltage of DC output	YES			
Over temperature protection	Derate since 50°C; Stop at 75°C			
Short circuit protection	YES			
Emergency stop protection	YES			
Leakage protection	Type A			
Lightning protection	Type II			

7.1 Electric diagram

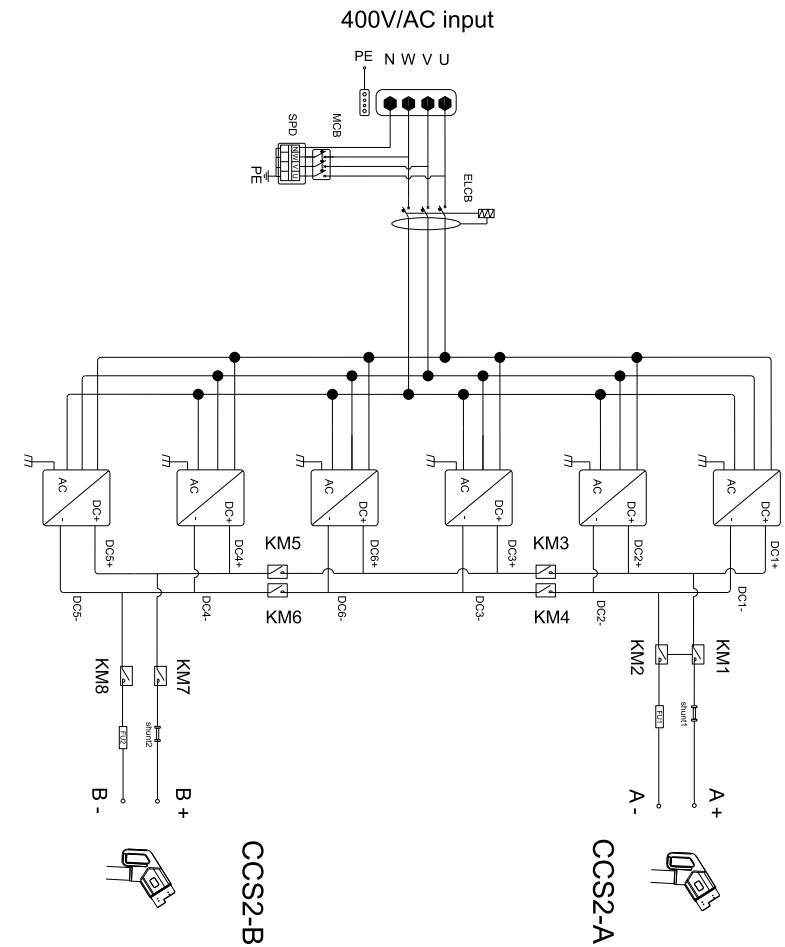
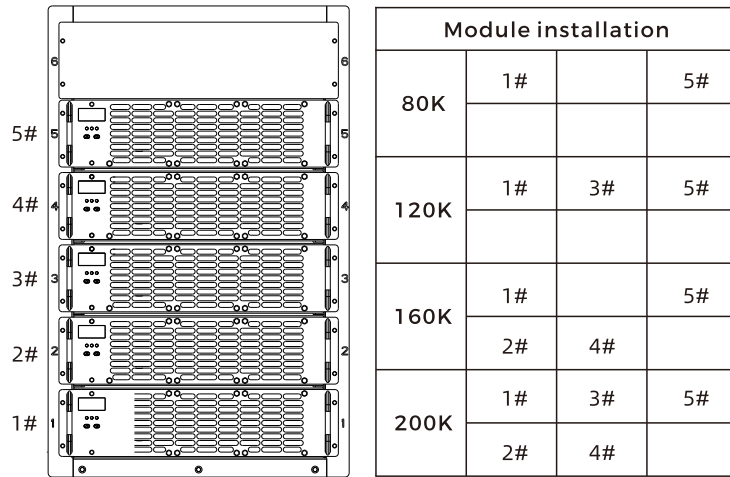

Fig7-1, Main circuit diagram

7.2 Module installation

1. Module installation position:



2. Address settings:

The rectifier module has two keys, the upper key (▲) and the lower key (▼). You can press buttons to view the information about the rectifier module.

For example, the output voltage of the rectifier module is 500V, the output current is 20A, the address is 2, the group number is 1, the operation is in automatic mode or manual mode, press ▲ or ▼ will be shown as follows in turn .

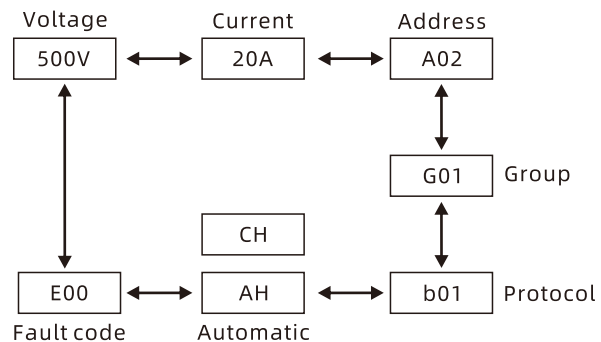

- ①. Press ▲ or ▼ to switch the current display to the information interface to be changed.
- ②. Press ▲ or ▼ about 2.5 seconds after release, you can see the display flashing.
- ③. Press ▲ or ▼ to change the settings.
- ④. Press the ▼ about 2.5 seconds after release to save the data; If the change is abandoned, press ▲ for about 2.5 seconds to release and revert to the previous setting.

3. Set the charging model on the system setting interface

The steps are as follows:

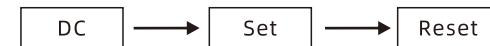

System parameters

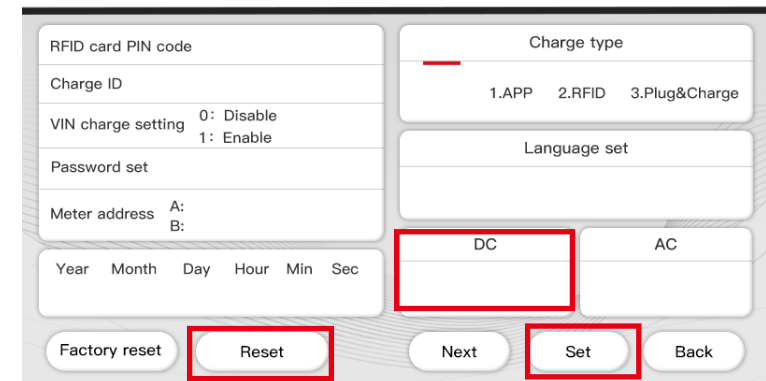

7.3 Warranty

Warranty period

The warranty period of this product is 3 year. If the contract stipulates otherwise, the contract shall prevail.

For warranty cases during the warranty period, the customer should present the invoice of the purchase of the product to the service personnel of ATESS. At the same time, the nameplate on the product should be clearly visible, otherwise the warranty claim might not be accepted.

Warranty condition

ATESS will repair or replace the product free of charge during the warranty period. The defective machine after replacement shall be owned by ATESS, and the customer shall reserve a certain amount of time for ATESS to repair the faulty machine.

Liability exemption

ATESS reserves the right not to accept the warranty claim if the conditions below happen,

- 1.No trademark on the product;
- 2.Warranty period has expired;
- 3.Fault or damage caused by incorrect installation, by installing the device in a not allowed environment, by improper storage or usage, etc.(e.g. too high or too low temperature, moisture or too dry environment, high altitude or unstable voltage/current, etc.)
- 4.Failure or damage caused by the installation, repair, modification or disassembly by unauthorized service personnel;
- 5.Failure or damage caused by using ATESS's genuine spare parts;
- 6.Damage or damage caused by accident or human cause (operational error, scratching, handling, bumping, access to inappropriate voltage, etc.), or transport damage;
- 7.Failure or damage caused by force majeure such as natural disasters (such as earthquakes, lightning strikes, fires, etc.);
- 8.Other failures or damages that are not caused by quality problem of the product or its components.

Statement of liability

The copyright of this manual belongs to ATESS. Any organization or individual may not extract or copy part or all of the contents of this manual without any written permission from ATESS, and may not be reproduced and spread in any form (including materials and publications). ATESS Co., Ltd. has the final right to interpret this manual. This manual is subject to change without prior notice.

For more information, please access www.atesspower.com.

7.4 Contact

Company Name: Shenzhen ATESS Power Technology Co.,Ltd

Address: GROWATT-ATESS Industrial Park, No.23 Zhulongtian Road, Shuitian Community, Shiyan Street, Baoan District, Shenzhen

Website: www.atesspower.com

Service line: +8675529988492

E-mail: info@atesspower.com