



ATESS EVC-AC22S/DC60D 82kW AC/DC charging equipment user manual

Shenzhen Ateess Power Technology Co.,Ltd

3rd floor, building 9, Henglong industrial park, the fourth industrial zone of Shuitian community,
Baoan district, Shenzhen, China

T + 86 755 2998 8492

E info@atesspower.com

W www.atesspower.com

Copyright Notice

This user manual is copyrighted by Shenzhen ATESS Power Technology Co., Ltd. (hereinafter referred to as "ATESS Power Technology"). No unit or individual may extract or copy part or all of this user manual without the written permission of the company. Content must not be transmitted in any form, including materials and publications.
All rights reserved. ATESS Power Technology has the final interpretation of this user manual. The product specification may be updated from time to time and is subject to change without prior notice!

Thank you for choosing ATESS charging equipment

ATESS EVC series intelligent AC/DC charging equipment is a device that provides high-efficiency, safe and stable AC/DC power supply for electric vehicles, which has a friendly man-machine interface and integrates corresponding functions of control, billing, communication and security protection. The charging equipment uses OCPP 1.6JSON open protocol for communication with back-office server, thus to realize functions such as reservation and network payment via mobile APP. Diversified communication options, including wired Ethernet, WIFI, 4G, wireless, are provided for customers to conveniently connect the device to a charging network. This product supports CCS/Type 2. Each connector works independently. Up to 3 EV could be charged at the same time. All the above features make it most suitable for outdoor charging.

We sincerely hope that this product can meet your needs, and we welcome and value your feedback and suggestions on the performance and function of the product. We will continuously improve the quality of our products and services.

Menu

- I. Product description.....1
- II. Packaging list..... 3
- III. Installation and wiring..... 3
- IV. Parameter configuration
 - 4.1 System Parameters..... 7
 - 4.2 Network parameters..... 8
 - 4.3 Protection parameters.....10
- V. Operation instruction and LCD introduction
 - 5.1 Charging mode and operation..... 11
 - 5.2 LCD interface introduction.....13
 - 5.3 Appendix: Fault code15
- VI. Specification16
- VII. Appendix
 - 7.1 Electric diagram18
 - 7.2 Warranty.....19
 - 7.3 Contact..... 20

I. Product description

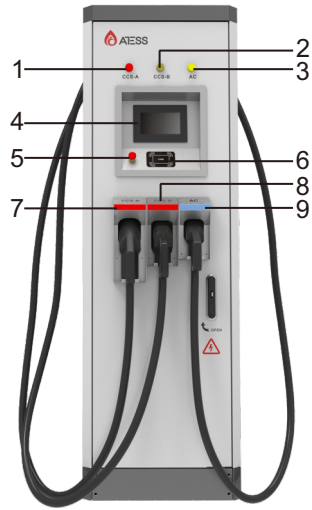

- 1.CCS-A connector indicator(charging yellow/fault red)
- 2.CCS-B connector indicator(charging yellow/fault red)
- 3.Type 2 AC connector indicator(charging yellow/fault red)
- 4.HMI
- 5.Emergency Stop button
- 6.RFID reader
- 7.CCS-A
- 8.CCS-B
- 9.Type 2 cable

Internal view and terminal definition

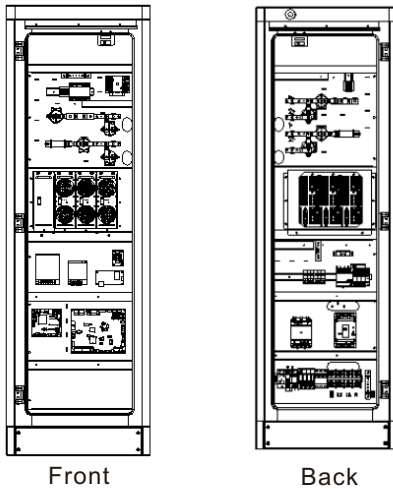

Crimp the below shown ring terminals on the end of the AC input wires and PE wires.
Connect the wires into the terminal block of the chargepoint as below.
Check the wiring then close the switch and the door.

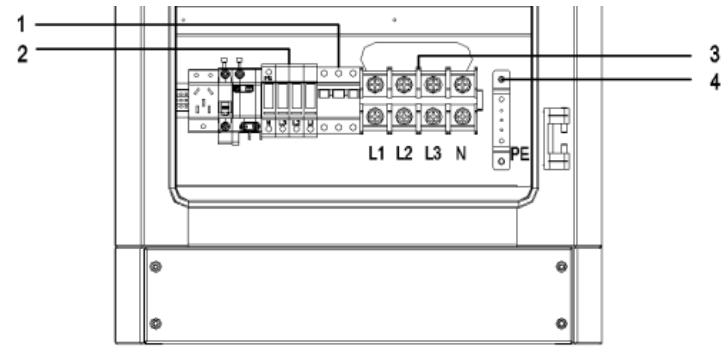

- 1.Breaker in surge protection circuit;
- 2.SPД
- 3.AC input terminal block. Terminal definition is (①L1; L2; L3; N) from left to right;
- 4.PE terminal;



Fig: AC Surge protection device

Note: The charging equipment will detect the current status of the lightning arrester module in real time. When the lightning protection module is damaged, the display will have an alarm indicating that the lightning protection device is faulty. When repairing and replacing the lightning protection module. Then the maintenance person can operate the breaker in the surge protection circuit and replace the lightning protection module! (The red circle in the figure is the lightning protection status indicator. When the indication window indicates green, the lightning protection module is normal; when the indication window indicates red, the lightning protection module has been broken and damaged, and the lightning protection module needs to be replaced.)

II. Packaging list

No.	Items	Qty	Remark
1	charging equipment	1	
2	User manual	1	
3	Certificate of quality	1	
4	Mounting bracket	1	Already installed on the rear side of the charging equipment
5	User card	3	
6	Hex head expansion bolt, M8*80/304 stainless steel	9	

2) The charger must be installed on a customized concrete foundation, the foundation is as below:

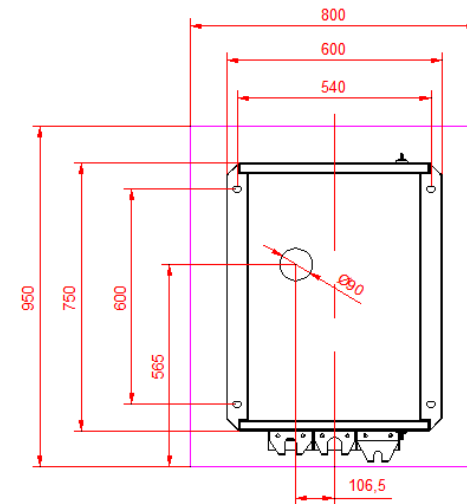
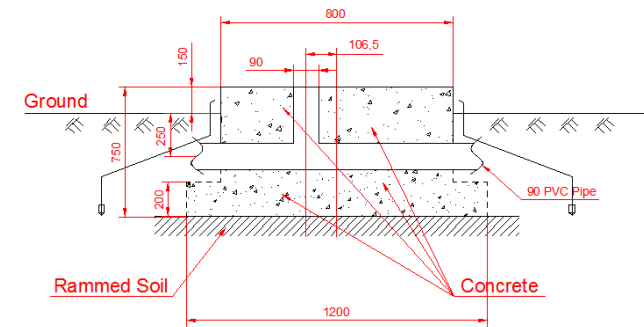

Concrete foundation diagram

Annotation:

- 1.The foundation pile must be tamped. On loose and moist soil, the foundation must be reinforced. The foundation must sit at the highest point of the area to avoid flooding water.
- 2.The foundation pile is to be made of reinforced concrete, which requires for a minimum allowable bearing pressure of 1000kg/sqire meters for the base.
3. Construct main grounding busbar and electrode following the grounding regulation of transformer substation. Grounding resistance should be lower than 4Ω , 50x4 galvanized flat steel is suggested.
- 4.Cable conduit uses PVG of 150mm diameter, the direction should be determined according to the situation on site, while the quantity is according to how many HV/LV cables will be used(use redundant design) .
- 5.Level bar should be used to level the foundation ground.

III. Installation and wiring

3.1 Installation conditions

1) keep a minimum clearance of 1.2m all around the charger, as follows:

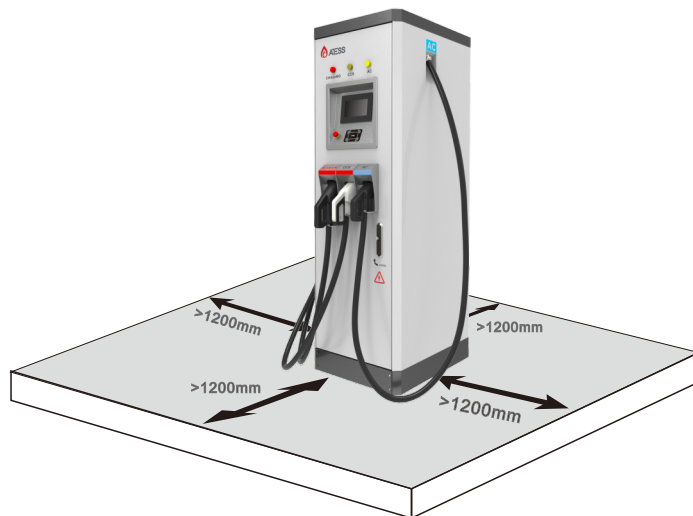

3) The minimum height of foundation is 150mm above ground, the vertical inclination degree should be less than 5%.

3.2 Cable connection

Connect the buried three phase four wire AC cables to the input terminal of the charger with correct color order and phase sequence. The earth cable shall be connected to the grounding bar of the charger. Wiring illustration is shown in elow. Please notice: For safety, the charger must be grounded securely. Connect the grounding bar of the charger to the equipotential bonding bar of the installation site. The grounding cable should be no less than 25mm². Grounding resistance shall be less than 4Ω.

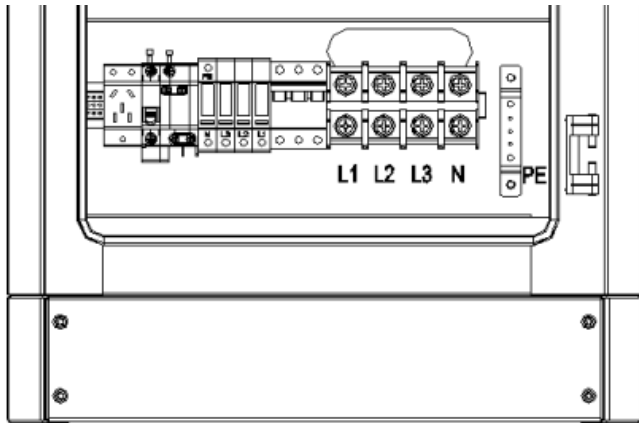

	L1	L2	L3	N	PE
Terminal					
Wire	≥50mm ² ≥AWG0	≥50mm ² ≥AWG0	≥50mm ² ≥AWG0	≥50mm ² ≥AWG0	≥25mm ² ≥AWG3

Notice :

1. Only professional personnel can do the wiring, connect the AC input wires in correct phase order according to the markings on the terminal block.
2. The PE terminal shall be connected to the Earth firmly and reliably!
3. No live work! Turn off the upstream breaker in the distribution panel and the breaker inside the charging equipment before repairing or maintaining.
4. Please do no disassemble the unit unless authorized!

IV. Parameter configuration

After installed and connected, the charging equipment must first be configured according to the actual needs of the user. The parameters are configured through the LCD touch screen. Save the change and exit then the charging equipment can be used normally.



After the system enters standby, click the button marked by the red rectangle in the above figure to enter the system management page, as shown below.

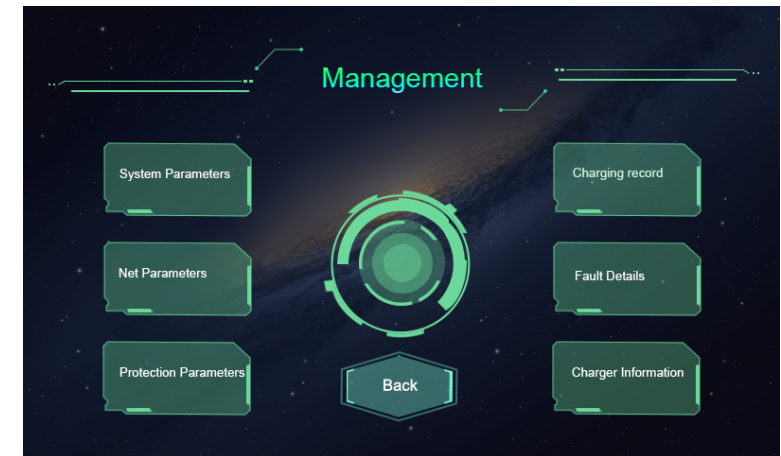

System management page

4.1 System Parameters

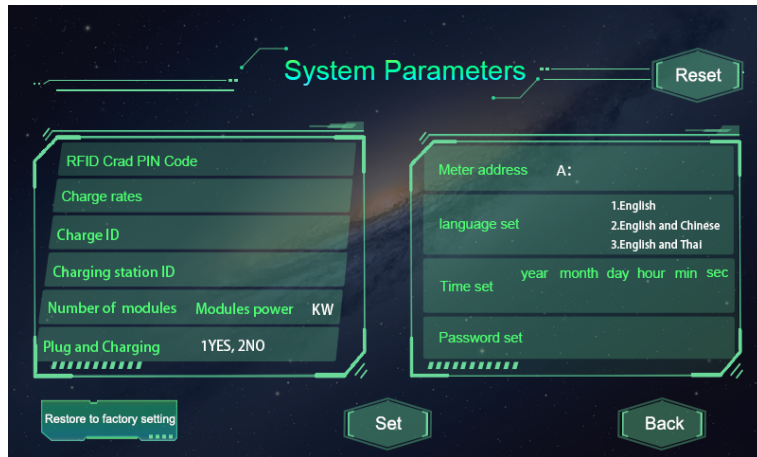

System Parameters page

No.	Parameters	Function description
8	Meter address	DC meter's modbus address(already preset in factory, it is not allowed to modify)
9	Language set	Language setting. Currently support Thai-English and Thai-Chinese dual language display.
10	Time set	System time setting. Format is Y, M, D, H, M, S. The Year setting can only set the last 2 digits, e.g. use 19 for 2019.
11	Password set	Password of management page. It's a 4-digit fixed length password, default is "1234".

After changing parameters, click the "Set" button to save the setting, then click the "Back" button for the setting to take effect.

4.2 Network parameters

Network parameters need to be configured when the charging station needs to be connected to back office server for operation and management. Network parameters include server parameters and charger parameters. Currently the charging equipment only support LAN connection ,WIFI/4G is yet to develop

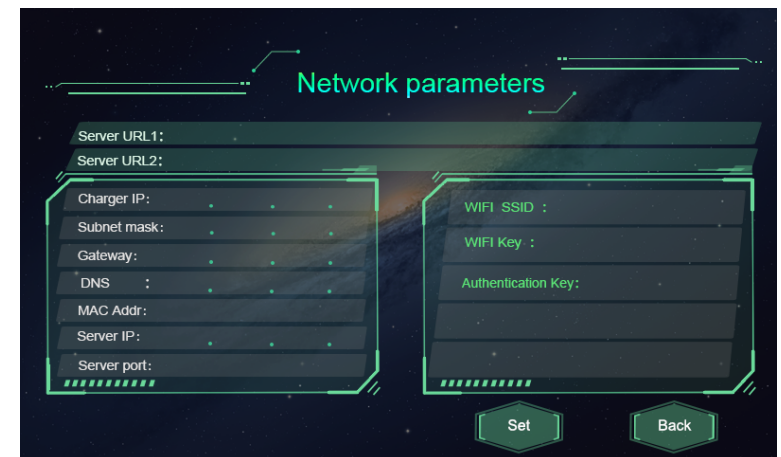

No.	Parameters	Function description
1	RFID Card PIN CODE	PIN code setting of RFID reader, a 6-digit code, the default setting is 242007.It must be the same with the PIN code of user card. Users can also use other PIN code if they have card writer to change PIN code of user card.
2	Tariff rate	Charging tariff setting, used to set the price per kWh.
3	Charge ID	Charger ID, suggested touse serial number as charger ID.
4	Charging station ID	Identification number of charging station. (one charging station may consist of multiple charging equipment).
5	Number of power modules	Number of power modules inside the mode 4 charging equipment.
6	Modules power	Rated power setting of power module
7	Plug and Charging	Charging mode setting. 1 is Plug&charge mode, payment is not needed; 2 is APP or RFID mode.

No.	Parameters	Function description
1	Server URL1	Server address setting, used to set domain or IP address of back-office server.
2	Server URL2	Address of backup server. This parameter is not available now, reserved for future use.
3	Charger IP	IP setting of the charging equipment
4	Subnet mask	Subnet mask setting
5	Gateway	Gateway setting
6	DNS	DNS server address
7	MAC Addr	MAC address
8	Server IP	Server IP address
9	Server port	Server port number
10	WIFI SSID	WIFI SSID setting, to set the name of the wireless network to which the charging equipment is to be connected. A reserved function for future use
11	WIFI Key	WiFi password setting. A reserved function for future use
12	Authentication Key	OCPP login authentication setting

If the charger is connected to the server through the network cable, the Charger IP, Subnet mask and Gateway need to be set. Through WiFi, you need to set WiFi SSID and WiFi Key. With 4G, you can connect to the server by installing a SIM card.

4.3 Protection parameters

The protection-related parameters, such as voltage, current, temperature, power, etc.

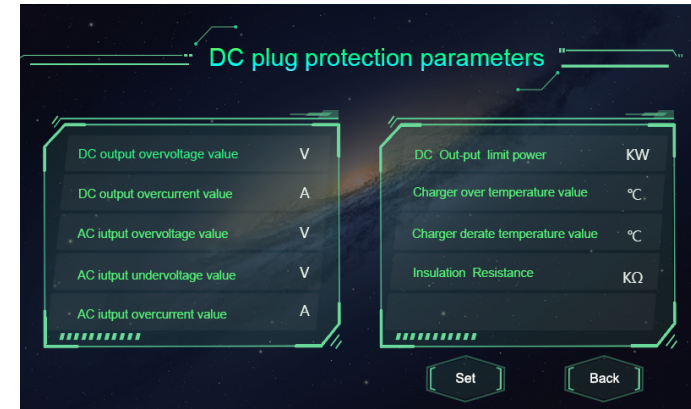

No.	Parameters	Function description
1	DC output overvoltage value	Over voltage limit setting of DC output
2	DC output overcurrent value	Over current limit setting of DC output
3	AC input overvoltage value	Over voltage limit setting of AC input
4	AC input undervoltage value	Under voltage limit setting of AC input
5	AC input overcurrent value	Over current limit setting of AC input
6	DC output limit power	Power limitation setting of DC output
7	Charger over temperature value	Over temperature limit setting of charging connector
8	Charger derate temperature value	Charging connector's temperature at which the charging equipment starts decreasing output power
9	Insulation Resistance	The min value of insulation resistance

4.4 Plug type

There are CCS and type 2 two kind of plus optional.

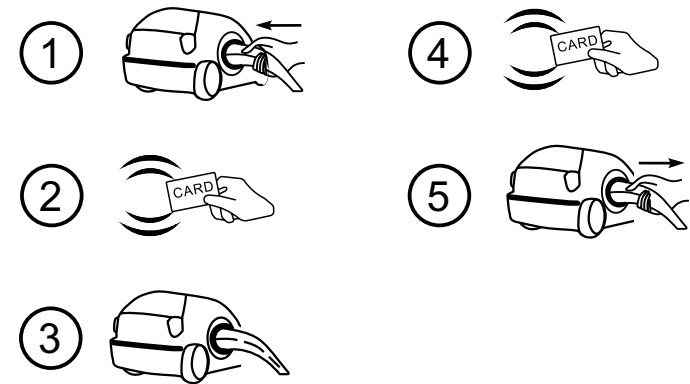
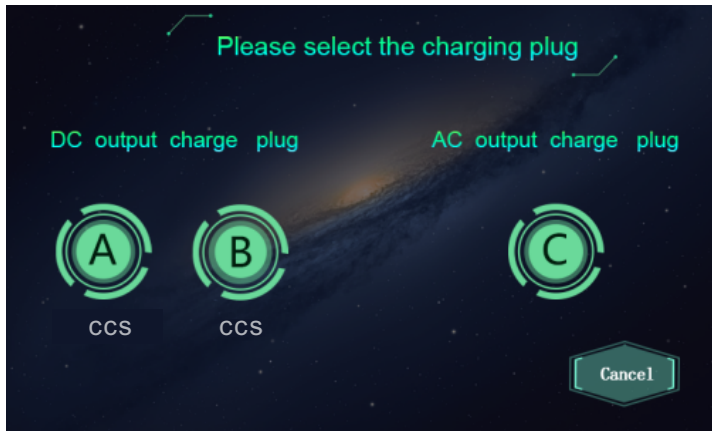

APP/RFID mode operation process flow

V. Operation instruction and LCD introduction

5.1 Charging mode and operation

APP/RFID mode:

Initiate or cease charging by scanning QR code using APP or by swiping RFID card.

You can also use APP for reservation and payment provided that the back-office server supports such function;



Plug&Charge :

Charging will start automatically after EV plugged in. If you want to stop the charging, just press the stop icon on the screen.

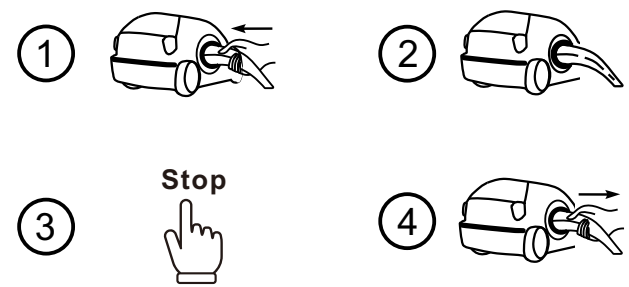



Plug&Charge mode operation process flow

5.2 LCD interface introduction

The charging equipment is equipped with a 7 inch industrial-grade resistor type touch panel. The display content is as below,

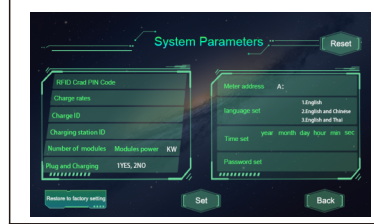
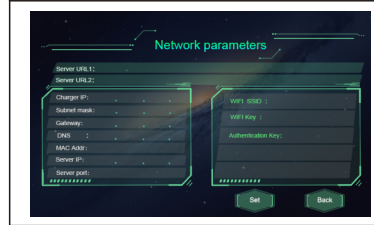
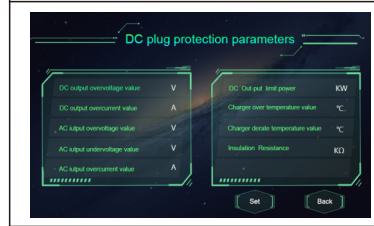
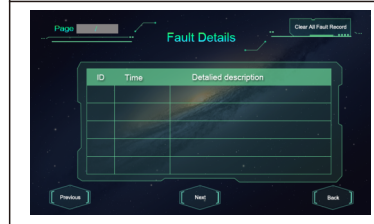
 <p>Welcome to use DC Charger</p> <p>Please swipe card or scan QRCode to start charging</p> <p>Operation Manual Management Charging Setting</p>	<p>When powered up, the charging equipment will show this display,</p>
 <p>DC Plug Charging Information</p> <p>BMS info</p> <p>Out-Voltage: V</p> <p>Out-Current: A</p> <p>Out-Power: Kwh</p> <p>Charging time: hour min sec</p> <p>Time left: hour min sec</p> <p>Money used: baht</p> <p>Balance: baht</p> <p>Start Stop Management Start Stop</p>	<p>Charging information, which will show the status of the charging equipment, such as standby, charging, fault, etc.</p>
 <p>Management</p> <p>System Parameters</p> <p>Net Parameters</p> <p>Protection Parameters</p> <p>Charging record</p> <p>Fault Details</p> <p>Charger Information</p> <p>Back</p>	<p>Management page, user can set different kinds of parameters here. Password authentication is required when entering each parameter setting page.</p>
 <p>Please enter password</p> <p>1 2 3</p> <p>4 5 6</p> <p>7 8 9</p> <p>0 Enter</p> <p>return</p> <p>Back</p>	<p>Password window. Before entering numeric, please first press the text display field to move the cursor there, then you can type in the 4-digit password. A wrong password will cause no response and action.</p>

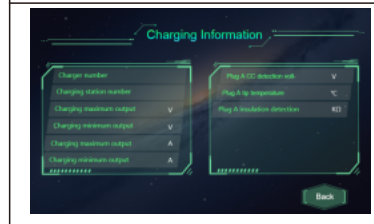
 <p>System Parameters</p> <p>RFID Card PIN Code</p> <p>Charge rates</p> <p>Charge ID</p> <p>Charging station ID</p> <p>Number of modules</p> <p>Module power</p> <p>Plug and Charging</p> <p>Reset</p> <p>Set Back</p>	<p>System parameters page.</p>																																										
 <p>Network parameters</p> <p>Server URL:1</p> <p>Server URL:2</p> <p>Charge ID</p> <p>Station name</p> <p>Gateway</p> <p>DNS</p> <p>MAC Addr</p> <p>Server IP</p> <p>Server port</p> <p>Work mode</p> <p>WiFi key</p> <p>Authentication key</p> <p>Set Back</p>	<p>Network parameters page, used to set network related parameters of back-office server and the charging equipment.</p>																																										
 <p>DC plug protection parameters</p> <p>DC output overvoltage value</p> <p>DC output overcurrent value</p> <p>AC input overvoltage value</p> <p>AC input undervoltage value</p> <p>AC input overcurrent value</p> <p>DC Out put limit power</p> <p>Charger near temperature value</p> <p>Charger details temperature value</p> <p>Insulation Resistance</p> <p>Set Back</p>	<p>Protection parameters page of DC output, used to set limit value of voltage, current, power, temperature, etc.</p>																																										
 <p>Fault Details</p> <table border="1"> <thead> <tr> <th>ID</th> <th>Time</th> <th>Detailed description</th> </tr> </thead> <tbody> <tr><td> </td><td> </td><td> </td></tr> <tr><td> </td><td> </td><td> </td></tr> <tr><td> </td><td> </td><td> </td></tr> <tr><td> </td><td> </td><td> </td></tr> <tr><td> </td><td> </td><td> </td></tr> </tbody> </table> <p>Previous Next Back</p>	ID	Time	Detailed description																<p>Fault record page, user can check history fault record here.</p>																								
ID	Time	Detailed description																																									
 <p>Charge Record</p> <table border="1"> <thead> <tr> <th>ID</th> <th>Start Time</th> <th>End Time</th> <th>Electricity (kWh)</th> <th>Price (Baht/kWh)</th> <th>Money (Baht)</th> <th>Stop Reason</th> </tr> </thead> <tbody> <tr><td> </td><td> </td><td> </td><td> </td><td> </td><td> </td><td> </td></tr> <tr><td> </td><td> </td><td> </td><td> </td><td> </td><td> </td><td> </td></tr> <tr><td> </td><td> </td><td> </td><td> </td><td> </td><td> </td><td> </td></tr> <tr><td> </td><td> </td><td> </td><td> </td><td> </td><td> </td><td> </td></tr> <tr><td> </td><td> </td><td> </td><td> </td><td> </td><td> </td><td> </td></tr> </tbody> </table> <p>Previous Next Back</p>	ID	Start Time	End Time	Electricity (kWh)	Price (Baht/kWh)	Money (Baht)	Stop Reason																																				<p>Charging record page.</p>
ID	Start Time	End Time	Electricity (kWh)	Price (Baht/kWh)	Money (Baht)	Stop Reason																																					
 <p>Charging Information</p> <p>Charger number</p> <p>Charging station number</p> <p>Charging maximum output</p> <p>Charging minimum output</p> <p>Charging maximum output</p> <p>Charging minimum output</p> <p>Charging maximum output</p> <p>Charging minimum output</p> <p>Plug & DC detection volt</p> <p>Plug & DC temperature</p> <p>Plug & Insulation detection</p> <p>Set Back</p>	<p>Charging information page, to check real-time charging parameters.</p>																																										

5.3 Appendix: Fault code

No.	Fault description
1	Emergency stop is pressed!
2	RFID communication fault!
3	Over temperature fault!
4	Lightning protection fault!
5	Power module communication fault!
6	Meter communication fault!
7	DC output overvoltage fault!
8	DC output overcurrent fault!
9	Waiting for BMS communication timeout!
10	Insulation detection timeout!
11	Insulation detection fault!
12	Battery voltage reverse fault!
13	DC+ Contactor sticking fault!
14	DC- Contactor sticking fault!
15	Plug line disconnection fault!
16	Plug head connection over temperature fault!
17	AC Contactor sticking fault!
18	AC Input Overvoltage!
19	AC Input Undervoltage!
20	BMS communication fault!

VI. Specification

Model	EVG-AC22S/DC60D
Dimension(mm)	1883*600*743(W*H*D)
Weight(kg)	250KG
Display	LCD
Casing material	Stainless steel&acrylic sheet
AC input	
Grid connection	400V, 3 phase 5 wires
Voltage	AC 400V
Current	150A
Frequency	50Hz
AC output	
Voltage	400VAC
Current	32A
Power	22kW
DC output	
Plug type	CCS
Voltage	DC150~750V
Current	0-120A
Voltage-stabilizing accuracy	< ±0.5%
Current-stabilizing accuracy	≤ ±1% (at 20%~100% of rated power)
Power factor	≥0.95 @20%~50% of full load output power ≥0.98 @50%~100% of full load output power ≥0.99 @100% full load output power, rated input voltage and frequency
Efficiency	≥95.2%, @750V, 50%~100% of rated current and rated input voltage

7.1 Electric diagram

IP degree	Ip54
Working environment	-25°C~+50°C
Relative humidity	Non-condensing
Altitude	≤2000m, derate for higher than 2000m
Cooling method	Forced air cooling
Remote monitoring	Ethernet/WIFI/4G/485/232
Payment	RFID/APP
Standby power	25W
Standards	IEC-62196-1;IEC-62196-2;IEC-62196-3;
Mounting	Ground
Certificate	CE
Metering accuracy	0.5
Protection features	
Low and high trip limit of AC input voltage	Adjustable within 260~457V AC
Over voltage trip limit of DC output	Adjustable within 260V~778V DC or 260V~500V
Over temperature protection	Derate since 50°C; Stop at 75°C
Short circuit protection	Yes
Emergency stop protection	Yes
Leakage protection	Type A
Lightning protection	Type II

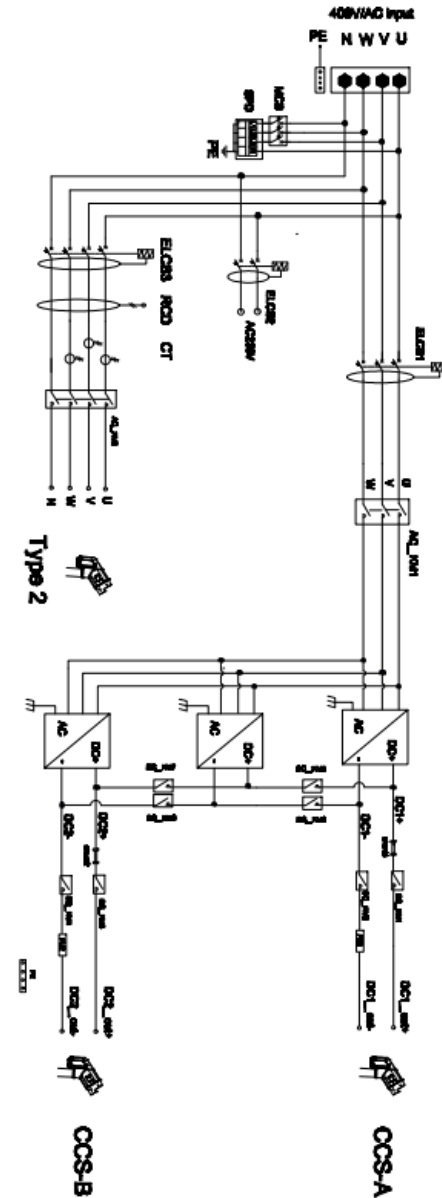

Fig7-1, Main circuit diagram

7.2 Warranty

Warranty period

The warranty period of this product is 1 year. If the contract stipulates otherwise, the contract shall prevail.

For warranty cases during the warranty period, the customer should present the invoice of the purchase of the product to the service personnel of ATESS Power Technology. At the same time, the nameplate on the product should be clearly visible, otherwise the warranty claim might not be accepted.

Warranty condition

ATESS Power Technology Co., Ltd. will repair or replace the product free of charge during the warranty period. The defective machine after replacement shall be owned by ATESS Power Technology, and the customer shall reserve a certain amount of time for ATESS Power Technology to repair the faulty machine.

Liability exemption

ATESS Power Technology reserves the right not to accept the warranty claim if the conditions below happen,

- 1.No ATESS logo on the product;
- 2.Warranty period has expired;
- 3.Fault or damage caused by incorrect installation, by installing the device in a not allowed environment, by improper storage or usage, etc.(e.g. too high or too low temperature, moisture or too dry environment, high altitude or unstable voltage/current, etc.)
- 4.Failure or damage caused by the installation, repair, modification or disassembly by unauthorized service personnel;
- 5.Failure or damage caused by using ATESS Power Technology's genuine spare parts;
- 6.Damage or damage caused by accident or human cause (operational error, scratching, handling, bumping, access to inappropriate voltage, etc.), or transport damage;
- 7.Failure or damage caused by force majeure such as natural disasters (such as earthquakes, lightning strikes, fires, etc.);
- 8.Other failures or damages that are not caused by quality problem of the product or its components.

Statement of liability

The copyright of this manual belongs to Shenzhen ATESS Power Technology Co., Ltd. Any organization or individual may not extract or copy part or all of the contents of this manual without any written permission from ATESS Power Technology, and may not be reproduced and spread in any form (including materials and publications). ATESS Power Technology Co., Ltd. has the final right to interpret this manual. This manual is subject to change without prior notice. For more information, please access www.atesspower.com.

7.3 Contact

Company Name:Shenzhen ATESS Power Technology Co.,Ltd

Address: 3rd floor, building 9, Henglong industrial park, the fourth industrial zone of Shuitian community, Baoan district, Shenzhen, China

Website: www.atesspower.com

Service line: +8675529988492

E-mail: info@atesspower.com