



ATESS EVD-40D 40kW DC charging equipment user manual

Shenzhen Ateess Power Technology Co.,Ltd
GROWATT-ATESS Industrial Park, No.23 Zhulongtian Road, Shuitian Community,
Shiyan Street, Baoan District, Shenzhen

T + 86 755 2998 8492
E info@atesspower.com
W www.atesspower.com

Revised date:2022-10-11

Copyright Notice

This user manual is copyrighted by Shenzhen ATESS Power Technology Co., Ltd. (hereinafter referred to as "ATESS Power Technology"). No unit or individual may extract or copy part or all of this user manual without the written permission of the company. Content must not be transmitted in any form, including materials and publications.

All rights reserved. ATESS Power Technology has the final interpretation of this user manual. The product specification may be updated from time to time and is subject to change without prior notice!

Thank you for choosing our charging equipment

EVD series intelligent DC charging equipment is a device that provides high-efficiency, safe and stable DC power supply for electric vehicles, which has a friendly man-machine interface and integrates corresponding functions of control, billing, communication and security protection. The charging equipment uses OCPP 1.6JSON open protocol for communication with back-office server, thus to realize functions such as reservation and network payment via mobile APP. Diversified communication options, including wired Ethernet, WIFI, 4G, wireless, are provided for customers to conveniently connect the device to a charging network. This product supports CCS and CHAdeMo. Each connector works independently. Up to 2 EV could be charged at the same time. All the above features make it most suitable for outdoor charging.

We sincerely hope that this product can meet your needs, and we welcome and value your feedback and suggestions on the performance and function of the product. We will continuously improve the quality of our products and services..

Menu

I. Product description.....	1
II. Packaging list.....	3
III. Installation and wiring.....	3
IV. Parameter configuration	
4.1 System Parameters.....	7
4.2 Network parameters.....	8
4.3 Protection parameters.....	10
V. Operation instruction and LCD introduction	
5.1 Charging mode and operation.....	11
5.2 LCD interface introduction.....	12
5.3 Appendix: Fault code	15
VI. Specification.....	16
VII. Appendix	
7.1 Electric diagram	18
7.2 Warranty.....	19
7.3 Contact.....	20

I. Product description

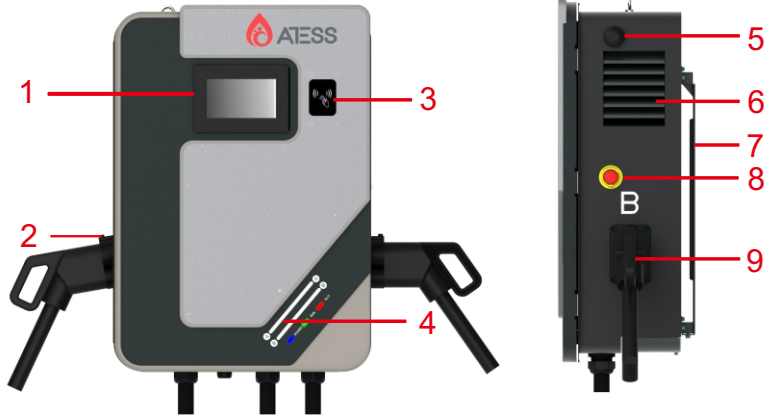

- 1. HMI;
- 2. Charging connector holder;
- 3. RFID reader;
- 4. LED indicators;
- 5. WIFI/4G antenna
- 6. Air outlet;
- 7. Mounting bracket;
- 8. Emergency Stop button;
- 9. Charging connector holder;

Explanation of LED indicators behaviors:
 Blue - Standby(The charging equipment can only be used when the blue light lit);
 Red Steady on/Flashing - Fault;
 Green Steady on - Charging in process;
 Green Flashing - Establishing communication;
 Yellow Flashing - System initializing.

Internal view and terminal definition

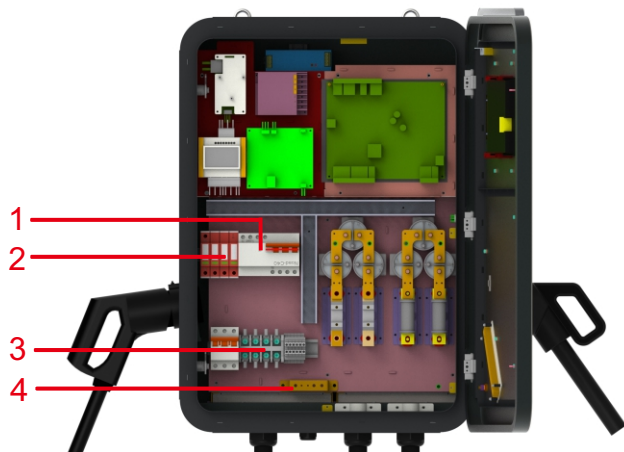

- 1.AC input RCBO;
- 2.SPД
- 3.AC input terminal block. Terminal definition is (①L1;②L2;③L3;④N)from right to left;
- 4.PE terminal;



Fig: AC Surge protection device

Note: The charging equipment will detect the current status of the lightning arrester module in real time. When the lightning protection module is damaged, the display will have an alarm indicating that the lightning protection device is faulty. When repairing and replacing the lightning protection module, the left side cover must be removed first. Then the maintenance person can operate the breaker in the surge protection circuit and replace the lightning protection module! (The red circle in the figure is the lightning protection status indicator. When the indication window indicates green, the lightning protection module is normal; when the indication window indicates red, the lightning protection module has been broken and damaged, and the lightning protection module needs to be replaced.)

II. Packaging list

No.	Items	Qty	Remark
1	Mode charging equipment	1	
2	User manual	1	
3	Certificate of quality	1	
4	Mounting bracket	1	Already installed on the rear side of the charging equipment
5	Cable hooker	2	
6	Hex head expansion bolt, M8*80/304 stainless steel	9	

III. Installation and wiring

1. Firstly, according to the specific installation height requirement of the user, determine the installation height of the charging equipment and the installation height of the cable hooker. According to the dimensions in the following drawings, drill 4 holes for bracket mounting and 3 holes for cable hooker mounting on the wall. Take out the expansion bolts in the packing accessory bag, hammer the expansion bolts into the holes. Remove the nuts and washers for later use.

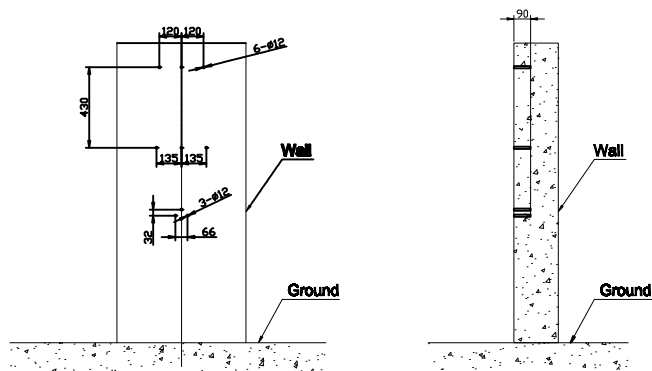

Drill holes on the wall

2. Loosen the 2 screws at the bottom of the charging equipment that fixes the mounting bracket, keep them properly for later use. Place the mounting bracket onto the bolts just installed and screw the nuts and washers. Take out the cable hooker and fix it using the same procedure.

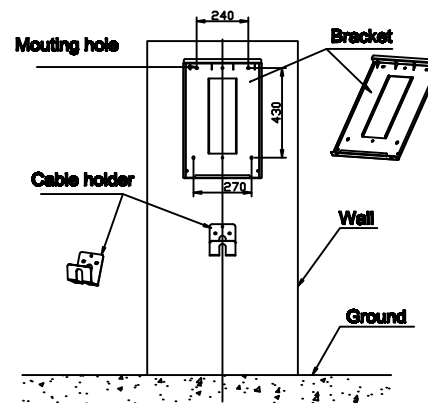



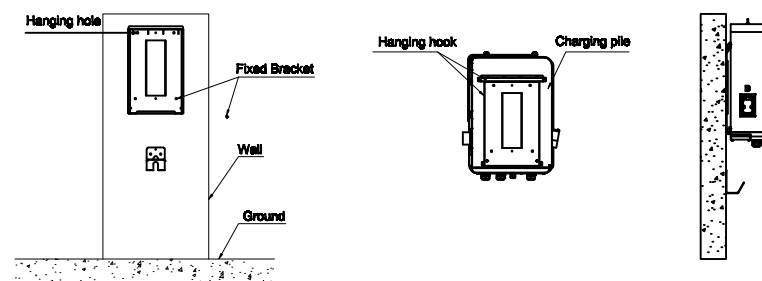

Mount the bracket and cable holder

3. After the mounting bracket and cable hooker is fixed, place the charging equipment onto the mounting bracket, with the outward bent part inserted to the slot on the rear side of the charging equipment. Lock the charging equipment onto the bracket at the bottom using the 2 screws. The installation is done.



Insert the hanging hooks of the charging pile into the hanging holes and install in place

4. Now prepare for wiring. Use 4 power cables and 1 PE cable, it is suggested to use a 5-core cable (with PE included) for the convenience of using the water-proof cable gland. The live wires shall be at least 16mm², PE shall be greater than 10mm². The PE wire shall be crimped to a M6 size ring terminal. Open the 2 locks at the left side of the upper front cover and open it. Connect the AC input cables into the corresponding terminals through the cable gland on the bottom left side and fasten them (Refer to the Internal view and terminal definition part for wire connection), put the transparent cover on the terminal block for safety purpose. Connect the network cable through the hole in front of the AC input cable gland to the RJ45 socket and fasten the water-proof gland. Turn on the RCBO. Close and lock the upper cover after checking internal wiring and breaker position. The wiring is then finished.

	L1	L2	L3	N	PE
Terminal					
Wire	≥16mm ² ≥AWG5	≥16mm ² ≥AWG5	≥16mm ² ≥AWG5	≥16mm ² ≥AWG5	≥10mm ² ≥AWG7

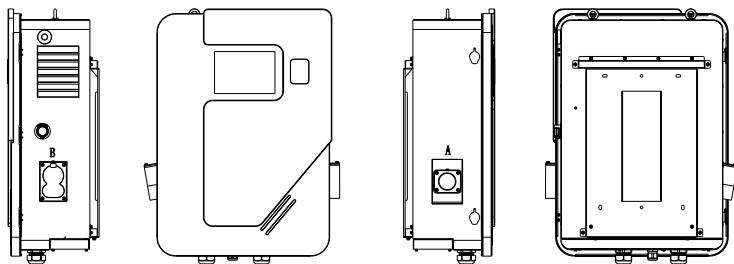

Notice

1. Only professional personnel can do the wiring, connect the AC input wires in correct phase order according to the markings on the terminal block.
2. The PE terminal shall be connected to the Earth firmly and reliably!
3. No live work! Turn off the upstream breaker in the distribution panel and the breaker inside the charging equipment before repairing or maintaining.
4. Please do not disassemble the unit unless authorized!

IV. Parameter configuration

After installed and connected, the charging equipment must first be configured according to the actual needs of the user. The parameters are configured through the LCD touch screen. Save the change and exit then the charging equipment can be used normally.



After the system enters standby, click the button marked by the red rectangle in the above figure to enter the system management page, as shown below.



System management page

4.1 System Parameters

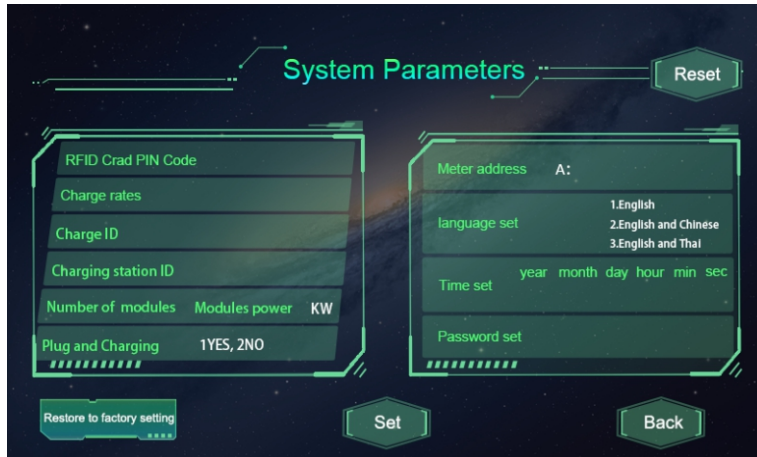

System Parameters page

No.	Parameters	Function description
8	Meter address	DC meter's modbus address(already preset in factory, it is not allowed to modify)
9	Language set	Language setting. Currently support Thai-English and Thai-Chinese dual language display.
10	Time set	System time setting. Format is Y, M, D, H, M, S. The Year setting can only set the last 2 digits, e.g. use 19 for 2019.
11	Password set	Password of management page. It's a 4-digit fixed length password, default is "1234".

After changing parameters, click the "Set" button to save the setting, then click the "Back" button for the setting to take effect.

No.	Parameters	Function description
1	RFID Card PIN CODE	PIN code setting of RFID reader, a 6-digit code, the default setting is 242007. It must be the same with the PIN code of user card. Users can also use other PIN code if they have card writer to change PIN code of user card.
2	Tariff rate	Charging tariff setting, used to set the price per kWh.
3	Charge ID	Charger ID, suggested touse serial number as charger ID.
4	Charging station ID	Identification number of charging station. (one charging station may consist of multiple charging equipment).
5	Number of power modules	Number of power modules inside the mode 4 charging equipment.
6	Modules power	Rated power setting of power module
7	Plug and Charging	Charging mode setting. 1 is Plug&charge mode, payment is not needed; 2 is APP or RFID mode.

4.2 Network parameters

Network parameters need to be configured when the charging station needs to be connected to back office server for operation and management. Network parameters include server parameters and charger parameters. Currently the charging equipment only support LAN connection, WiFi/4G is yet to develop.

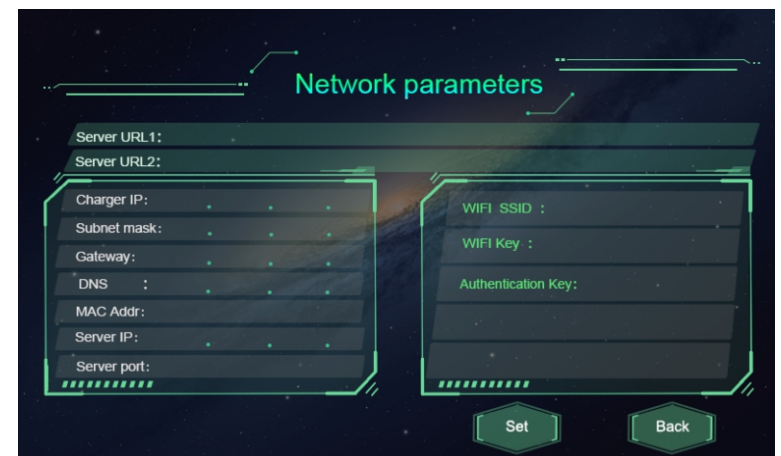

No.	Parameters	Function description
1	Server URL1	Server address setting, used to set domain or IP address of back-office server.
2	Server URL2	Address of backup server. This parameter is not available now, reserved for future use.
3	Charger IP	IP setting of the charging equipment
4	Subnet mask	Subnet mask setting
5	Gateway	Gateway setting
6	DNS	DNS server address
7	MAC Addr	MAC address
8	Server IP	Server IP address
9	Server port	Server port number
10	WIFI SSID	WIFI SSID setting, to set the name of the wireless network to which the charging equipment is to be connected. A reserved function for future use
11	WIFI Key	WiFi password setting. A reserved function for future use
12	Authentication Key	OCPP login authentication setting

4.3 Protection parameters

The protection-related parameters, such as voltage, current, temperature, power, etc.

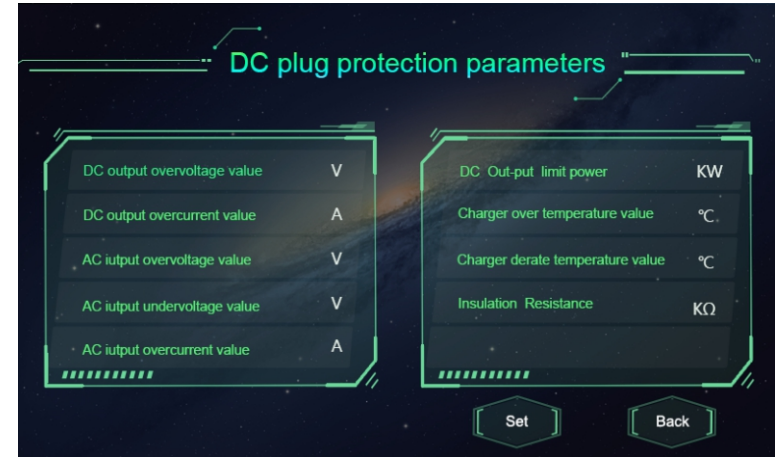

No.	Parameters	Function description
1	DC output overvoltage value	Over voltage limit setting of DC output
2	DC output overcurrent value	Over current limit setting of DC output
3	AC input overvoltage value	Over voltage limit setting of AC input
4	AC input undervoltage value	Under voltage limit setting of AC input
5	AC input overcurrent value	Over current limit setting of AC input
6	DC output limit power	Power limitation setting of DC output
7	Charger over temperature value	Over temperature limit setting of charging connector
8	Charger derate temperature value	Charging connector's temperature at which the charging equipment starts decreasing output power
9	Insulation Resistance	The min value of insulation resistance

V. Operation instruction and LCD introduction

5.1 Charging mode and operation

APP/RFID mode:

Initiate or cease charging by scanning QR code using APP or by swiping RFID card.

You can also use APP for reservation and payment provided that the back-office server supports such function;

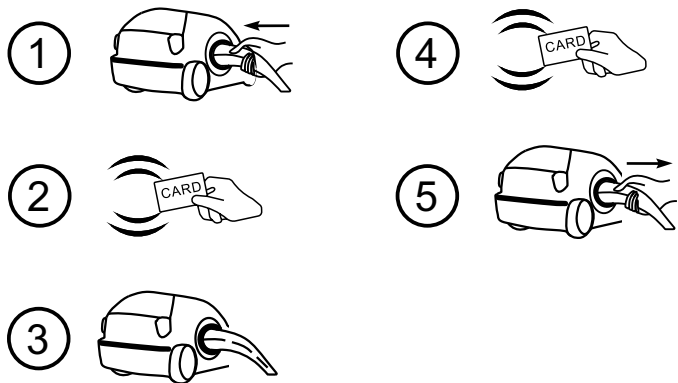

APP/RFID mode operation process flow

Plug&Charge :

Charging will start automatically after EV plugged in. If you want to stop the charging, just press the stop icon on the screen.

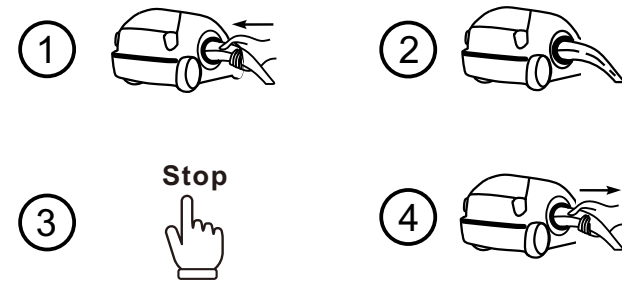

Plug&Charge mode operation process flow

5.2 LCD interface introduction

The charging equipment is equipped with a 7 inch industrial-grade resistor type touch panel. The display content is as below,

	<p>When powered up, the charging equipment will show this display,</p>
	<p>Charging information, which will show the status of the charging equipment, such as standby, charging, fault, etc.</p>



Management page, user can set different kinds of parameters here. Password authentication is required when entering each parameter setting page.

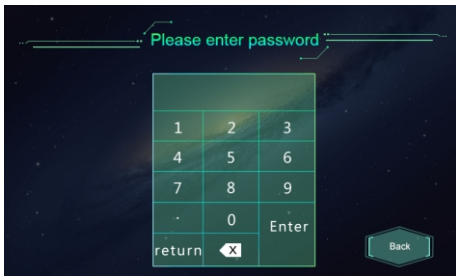

Password window. Before entering numeric, please first press the text display field to move the cursor there, then you can type in the 4-digit password. A wrong password will cause no response and action.

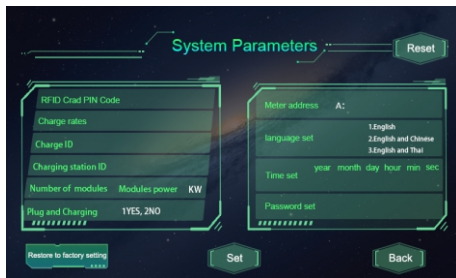

System parameters page.

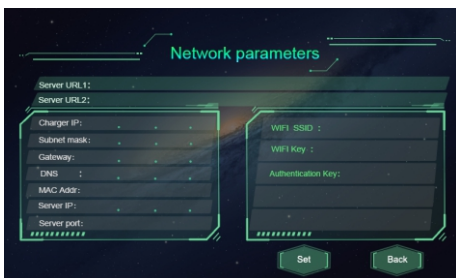

Network parameters page, used to set network related parameters of back-office server and the charging equipment.

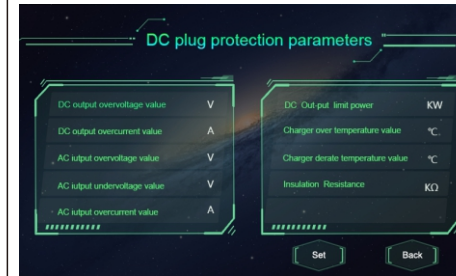

Protection parameters page of DC output, used to set limit value of voltage, current, power, temperature, etc.



Fault record page, user can check history fault record here.



Charging record page.

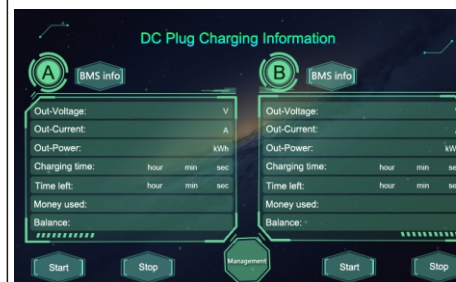

Charging information page, to check real-time charging parameters.

5.3 Appendix: Fault code

No.	Fault description
1	Emergency stop is pressed!
2	RFID communication fault!
3	Over temperature fault!
4	Lightning protection fault!
5	Power module communication fault!
6	Meter communication fault!
7	DC output overvoltage fault!
8	DC output overcurrent fault!
9	Waiting for BMS communication timeout!
10	Insulation detection timeout!
11	Insulation detection fault!
12	Battery voltage reverse fault!
13	DC+ Contactor sticking fault!
14	DC- Contactor sticking fault!
15	Plug line disconnection fault!
16	Plug head connection over temperature fault!
17	AC Contactor sticking fault!
18	AC Input Overvoltage!
19	AC Input Undervoltage!
20	BMS communication fault!

VI. Specification

Model	EVD-40D	
Dimension(mm)	775*556*270(L*W*H)	
Weight(kg)	80KG	
Display	LCD	
Casing material	Stainless steel&acrylic sheet	
AC input		
Nominal Voltage	400V	
Voltage range	AC 320~530V	
Current	≤64A	
Nominal Frequency	50/60Hz	
DC output		
Plug type	CCS	CHAdeMO
Voltage	DC150~750V	DC150~500V
Current	0-100A	
Voltage-stabilizing accuracy	< ±0.5%	
Current-stabilizing accuracy	≤ ±1% (at 20%~100% of rated power)	
Power factor	≥0.95 @20%~50% of full load output power ≥0.98 @50%~100% of full load output power ≥0.99 @100% full load output power, rated input voltage and frequency	
Efficiency	≥95.2%, @750V, 50%~100% of rated current and rated input voltage	

7.1 Electric diagram

IP degreeel	Ip54
Working environment	-25°C~+50°C, derate since 50°C
Relative humidity	5%-95%
Altitude	≤2000m, derate for higher than 2000m
Cooling method	Forced air cooling
Remote monitoring	Ethernet/WIFI/4G/485/232
Payment	RFID/APP
Standby power	25W
Standards	IEC-62196-1;IEC-62196-3;
Mounting	Wall or Pole
Certificate	CE
Metering accuracy	0.5
Protection features	
Low and high trip limit of AC input voltage	Adjustable within 260~530V AC
Over voltage trip limit of DC output	Adjustable within 260V~778V DC
Over temperature protection	Derate since 50°C; Stop at 75°C
Short circuit protection	Yes
Emergency stop protection	Yes
Leakage protection	Type A
Lightning protection	Type II

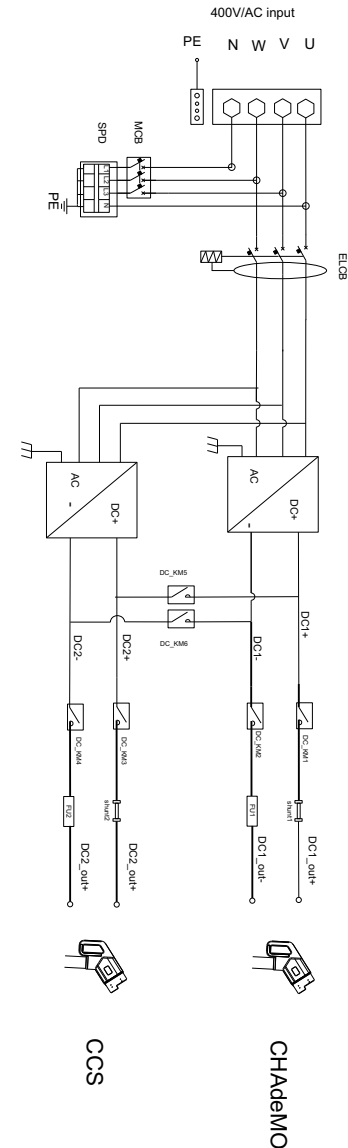

Fig7-1, Main circuit diagram

7.2 Warranty

Warranty period

The warranty period of this product is 1 year. If the contract stipulates otherwise, the contract shall prevail.

For warranty cases during the warranty period, the customer should present the invoice of the purchase of the product to our service team. At the same time, the nameplate on the product should be clearly visible, otherwise the warranty claim might not be accepted.

Warranty condition

We will repair or replace the product free of charge during the warranty period. The defective machine after replacement shall be owned by us, and the customer shall reserve a certain amount of time for us to repair the faulty machine.

Liability exemption

We reserves the right not to accept the warranty claim if the conditions below happen,

- 1.No trademark on the product;
- 2.Warranty period has expired;
- 3.Fault or damage caused by incorrect installation, by installing the device in a not allowed environment, by improper storage or usage, etc.(e.g. too high or too low temperature, moisture or too dry environment, high altitude or unstable voltage/current, etc.)
- 4.Failure or damage caused by the installation, repair, modification or disassembly by unauthorized service personnel;
- 5.Failure or damage caused by using our genuine spare parts;
- 6.Damage or damage caused by accident or human cause (operational error, scratching, handling, bumping, access to inappropriate voltage, etc.), or transport damage;
- 7.Failure or damage caused by force majeure such as natural disasters (such as earthquakes, lightning strikes, fires, etc.);
- 8.Other failures or damages that are not caused by quality problem of the product or its components.

Statement of liability

The copyright of this manual belongs to our company. Any organization or individual may not extract or copy part or all of the contents of this manual without any written permission from us, and may not be reproduced and spread in any form (including materials and publications). We have the final right to interpret this manual. This manual is subject to change without prior notice. For more information, please contact us.